

Panasonic®

Operating Instruction and Cook Book Microwave Oven Household Use Only

the Genius
INVERTER



© Panasonic Appliances Microwave Oven (Shanghai) Co., Ltd. 2016

F0003BQ40QP
PA0815-0
Printed in China

**Model Number:
NN-ST756B and NN-ST776S**

Please read these instructions carefully before using this product, and save this manual for future use.

Safety Instructions

READ CAREFULLY AND KEEP FOR FUTURE REFERENCE

Precautions to be taken when using Microwave Ovens for Heating foodstuffs

INSPECTION FOR DAMAGE. A microwave oven should only be used if an inspection confirms all of the following conditions:

1. The door fits squarely and securely and opens and closes smoothly.
2. The door hinges are in good condition.
3. The metal plates of a metal seal on the door are neither buckled nor deformed.
4. The door seals are neither covered with food nor have large burn marks.

PRECAUTIONS. Microwave radiation from microwave ovens can cause harmful effects if the following precautions are not taken:

1. Never tamper with or deactivate the interlocking devices on the door.
2. Never poke an object, particularly a metal object, through a grille or between the door and the oven while the oven is operating.
3. Never place saucepans, unopened cans or other heavy metal objects in the oven.
4. Do not let other metallic articles, e.g., fast food foil containers, touch the side of the oven.
5. Clean the oven cavity, the door and the seals with water and a mild detergent at regular intervals. Never use any form of abrasive cleaner that may scratch or scour surfaces around the door.
6. Always use the oven with trays or cookware recommended by the manufacturer.
7. Never operate the oven without a load (i.e., an absorbing material such as food or water) in the oven cavity unless specifically allowed in the manufacturer's literature.
8. For horizontally hinged doors, never rest heavy objects such as food containers on the door while it is open.
9. Do not place sealed containers in microwave ovens. Baby bottles fitted with a screw cap or a teat are considered to be sealed containers.
10. This appliance is not intended for use by persons (including children) with reduced physical, sensory or mental capabilities, or lack of experience and knowledge, unless they have been given supervision or instruction concerning use of the appliance by a person responsible for their safety.
11. Young children should be supervised to ensure that they do not play with the appliance.
12. It is hazardous for anyone other than a competent person to carry out any service or repair operation that involves the removal of a cover which gives protection against exposure to microwave energy.
13. The surfaces are liable to get hot during use.

Important Instructions

WARNING—To reduce the risk of burns, electric shock, fire, injury to persons or excessive microwave energy:

1. Read all instructions before using the microwave oven.
2. Some products such as whole eggs and sealed containers - (for example, closed glass jars **and sealed baby bottles with teat**) - may explode and should not be heated in the microwave oven.
3. Use this microwave oven only for its intended use as described in this manual.
4. As with any appliance, close supervision is necessary when used by children.
5. Do not operate this microwave oven if it is not working properly or if it has been damaged or dropped.
6. Do not store or use this appliance outdoors.
7. Do not immerse cord or plug in water.
8. Keep cord away from heated surfaces.
9. Do not let cord hang over edge of table or counter.
10. To reduce the risk of fire in the oven cavity:
 - (a) Do not overcook food. Carefully attend microwave oven if paper, plastic, or other combustible materials are placed inside the oven to facilitate cooking.
 - (b) Heating therapeutic wheat bags is not recommended. If heating, do not leave unattended and follow manufacturers' instructions carefully.
 - (c) Remove wire twist-ties from bags before placing bag in oven.
 - (d) If materials inside the oven should ignite, keep oven door closed, turn oven off at the wall switch, or shut off power at the fuse or circuit breaker panel.
 - (e) Never leave microwave unattended while cooking or reheating.
11. Do not remove outer panel from oven.
12. Appliances are not intended to be operated by means of an external timer or separate remotecontrol system.
13. Failure to maintain the oven in a clean condition could lead to deterioration of the surface that could adversely affect the life of the appliance and possibly result in a hazardous situation.

Installation and General Instructions

Earthing Instructions

This microwave oven must be earthed. In the event of an electrical short circuit, earthing reduces the risk of electric shock by providing an escape wire for the electric current. This microwave oven is equipped with a cord having an earthing wire with an earthing plug.

The plug must be plugged into an outlet that is properly installed and earthed.

WARNING—Improper use of the earthing plug can result in a risk of electric shock.

WE CERTIFY THAT THIS MICROWAVE OVEN HAS BEEN INSPECTED AND COMPLIES WITH THE REQUIREMENTS OF REGULATION 3, SUBCLAUSE(2), OF THE MICROWAVE OVENS REGULATIONS 1982.

(This statement applicable only to New Zealand.)

We certify that this microwave oven has been inspected and complies with the safety requirements of government notice 466 of March 1981, and complies with the Radio Regulation of government notice 587 of March 1986.

(This statement applicable only to South Africa)

WARNING

- a) The door seals and door seal areas should be cleaned with a damp cloth. The appliance should be inspected for damage to the door seals and door seal areas and if these areas are damaged the appliance should not be operated until it has been repaired by a qualified service technician trained by the manufacturer.
- b) It is hazardous for anyone other than a competent person to carry out any service or repair operation that involves the removal of a cover which gives protection against exposure to microwave energy.
- c) If the supply cord of this appliance is damaged, it must be replaced by a qualified service technician with the special cord available only from the manufacturer.
- d) Before use, the user should check that whether the utensils are suitable for use in microwave ovens.
- e) Liquids or other foods must not be heated in sealed containers since they are liable to explode.
- f) Only allow children to use the oven without supervision when adequate instructions have been given so that the child is able to use the oven in a safe way and understands the hazards of improper use.

General Use

1. In order to maintain high quality, do not operate the oven when empty. The microwave energy will reflect continuously throughout the oven if no food or water is present to absorb energy. This can lead to damage to the microwave oven including arcing within the oven cavity.
2. If smoke is observed, press the **STOP/RESET** Pad and leave door closed in order to stifle any flames. Disconnect the power cord, and/or shut off power at the fuse or circuit breaker panel.
3. Do not dry clothes, newspapers or other materials in oven. They may catch on fire.
4. Do not use recycled paper products, unless the paper product is labelled as safe for microwave oven use. Recycled paper products may contain impurities which may cause sparks and/or fires when used.
5. Do not use newspapers or paper bags for cooking.
6. Do not hit or strike the Control Panel. Damage to controls may occur.
7. **POT HOLDERS** may be needed as heat from food is transferred to the cooking container and from the container to the Glass Tray. The GlassTray can be very hot after removing the cooking container from the oven.
8. Do not store flammable materials next to, on top of, or in the oven. It could be a fire hazard.
9. Do not cook food directly on Glass Tray unless indicated in recipes. (Food should be placed in a suitable cooking utensil.)
10. **DO NOT** use this oven to heat chemicals or other non-food products. **DO NOT** clean this oven with any product that is labelled as containing corrosive chemicals. **The heating of corrosive chemicals in this oven may cause microwave radiation leaks.**
11. If glass tray is hot, allow to cool before cleaning or placing in water.
12. During cooking, some steam will condense inside and/or on the oven door. This is normal and safe. Steam will disappear after the oven cools down.
13. Do not leave the microwave unattended while reheating or cooking food in disposable containers made of plastic, paper or other combustible materials, as these types of containers can ignite if overheated.
14. The microwave oven is intended for heating food and beverages. Drying of food or clothing and heating of warming pads, slippers, sponges, damp cloth and similar may lead to risk of injury, ignition or fire.
15. Metallic containers for food and beverages are not allowed during microwave cooking

Installation and General Instructions (continued)

Placement of Oven

1. The oven must be placed on a flat, stable surface. For correct operation, the oven must have sufficient air flow. **Allow 15 cm of space on the top of the oven, 10 cm at the back, and 5 cm on both sides. If one side of the oven is placed flush to wall, the other side or top must not be blocked. Do not remove feet.**
 - a. Do not block air vents. If they are blocked during operation, the oven may be overheated and damaged. When using any cloth over the oven, the air intake and exhaust should not be blocked. Also allow sufficient space on back and both sides of the oven.
 - b. Do not place oven near a hot or damp surface such as a gas stove, electric range or sink etc.
 - c. Do not operate oven when room humidity is too high.
2. This oven was manufactured for household use only.

Building-in your oven

1. This oven is intended for counter-top and built-in use only. It is not intended for use inside a cupboard. This oven may be built into a wall cabinet by using the proper trim kit (NN-TK712SSQP) which may be purchased from your local Panasonic dealer.
2. In case of fitting into an oven housing, please use Panasonic's Trim Kit, NN-TK712SSQP.
3. Microwave ovens should not be built into a unit directly above a top front venting conventional cooker. This may be a safety hazard and could result in damage to your oven. This will invalidate your one year guarantee.
4. A microwave which is built in must be more than 850 mm above floor level. Read Trim-Kit instructions carefully before installation. It is recommended that the microwave oven is placed below a conventional oven to avoid heat damage to the fascia of the microwave.
5. Care should be taken not to displace the turntable when removing containers from the appliance.
3. Do not boil eggs in their shell and whole hard-boiled eggs (unless otherwise stated in Cooking Guide section). Pressure will build up and the eggs will explode.
4. Potatoes, apples, egg yolks, chicken wings, whole squash and sausages are examples of foods with nonporous skins. This type of food must be pierced before cooking, to prevent bursting.
5. When heating liquids, e.g. soup, sauces and beverages, in your microwave oven, overheating the liquid beyond boiling point can occur without evidence of bubbling. This could result in a sudden boil over of hot liquid. To prevent this possibility the following steps should be taken:
 - a) Avoid using straight-sided containers with narrow necks.
 - b) Do not overheat.
 - c) Stir the liquid before placing the container in the oven and halfway through cooking time.
 - d) After heating, allow to stand in the oven for a short time, stirring again before carefully removing the container.
 - e) Microwave heating of beverages can result in delayed eruptive boiling, therefore care should be taken when handling the container.
6. **DO NOT USE A CONVENTIONAL MEAT THERMOMETER IN THE MICROWAVE OVEN. To check the degree of cooking of roasts and poultry use a MICROWAVE THERMOMETER.** Alternatively, a conventional meat thermometer may be used after the food is removed from the oven. If undercooked, return meat or poultry to the oven and cook for a few more minutes at the recommended power level. It is important to ensure that meat and poultry are thoroughly cooked.
7. **COOKING TIMES given in the Cooking Guide section are APPROXIMATE.** Factors that may affect cooking time are preferred degree of moisture content, starting temperature, altitude, volume, size, shape of food and utensils used. As you become familiar with the oven, you will be able to adjust for these factors.
8. **It is better to UNDERCOOK RATHER THAN OVERCOOK foods.** If food is undercooked, it can always be returned to the oven for further cooking. If food is overcooked, nothing can be done. Always start with minimum cooking times recommended.
9. Extreme care should be taken when cooking popcorn in a microwave oven. Cook for minimum time as recommended by manufacturer. Use the directions suitable for the wattage of your microwave oven. NEVER leave oven unattended when popping popcorn.
10. When heating food in plastic or paper containers, check the oven frequently due to the possibility of ignition.
11. The contents of feeding bottles and baby food jars are to be stirred or shaken and the temperature is to be checked before consumption, in order to avoid burns.

Circuits

Your microwave oven should be operated on a separate 10 A circuit from other appliances. Failure to do this may cause the power board fuse to blow, and/or food to cook slower. Do not insert higher value fuse in the power board.

Food

1. Do not use your oven for home canning or the heating of any closed jar. Pressure will build up and the jar may explode. In addition, the microwave oven cannot maintain the food at the correct canning temperature. Improperly canned food may spoil and be dangerous to consume.
2. Do not attempt to deep fat fry in your microwave oven.

Microwaves and How They Work

Microwaves are a form of high frequency radio waves similar to those used by a radio, including AM, FM and CB. They are similar to a television where the radio waves are converted to a picture on the screen. However, microwaves are much shorter than radio waves; approximately twelve centimetres wave length. Electricity is converted into microwave energy by the magnetron tube (which is the heart of the microwave oven).

From the magnetron tube, microwave energy is transmitted to the oven cavity through a small plastic covered piece. The microwaves are converted to heat in the food. The microwaves enter from the outside of the food and travel through the food losing half of their power every two to three centimetres. Continued cooking to the centre occurs by conduction.

Although pacemakers used to be affected by microwaves (as well as by other radio waves), they are now shielded and are not bothered by these interferences. This allows people with pacemakers to sit calmly by their radio or television and cook with microwave ovens.

When microwaves come in contact with a substance, any one or combination of three things may occur.

They can be:

1. REFLECTED
2. TRANSMITTED
3. ABSORBED

Reflection:

Metal substances REFLECT microwave energy and because there is no absorption, there is no heating. This is why the oven interior is either stainless steel or epoxy-coated steel. This ensures that the microwaves are kept inside the cavity and evenly distributed throughout the food with the help of the turntable.

Transmission:

Such substances as paper, glass and plastic TRANSMIT microwave energy and do not become hot except from food. Because these substances do not reflect or absorb microwave energy, they are ideal materials for microwave cooking containers.

Absorption:

Food contains moisture and will ABSORB microwave energy, which causes the moisture molecules within the food to vibrate at an incredible rate (2,450,000,000 times per second). Friction, created by the vibration, produces heat energy which is conducted throughout the food.

Cookware and Utensils Guide

It is important to use the correct container when cooking in a microwave oven. The following will help you make the right selection.

How to Test a Container for Safe

Microwave Oven Use

TO TEST A CONTAINER FOR SAFE MICROWAVE

OVEN USE: Fill a 1-cup glass measure with cool water and place it in the microwave oven alongside the empty container to be tested; **heat one (1) minute at P10.** If the container is microwave oven safe (transparent to microwave energy), the container should remain comfortably cool, the water in glass measure should be hot. If the container is hot, it has absorbed some microwave energy and should NOT be used. This test cannot be used for plastic containers.

Paper Products and Freezer Wrap

Waxed paper, paper plates, cups and napkins should not be used for heating or cooking food. Freezer wrap should not be used as it is not heat resistant and may melt. Paper towel, greaseproof paper and bake paper may be safely used for short periods of time for covering or lining.

Glass, Ceramic and China

Ceramic cookware or dinnerware that has cracks or imperfections should not be used even if Microwave safe.

Heat-Resistant glass cookware is invaluable in microwave cooking. Many of these items are readily available in most homes: glass jugs, mixing bowls, loaf dishes, covered casseroles, oblong baking dishes, pie plates and round or square cake dishes. Examples of this type of cookware are Pyrex® and Corningware®.

Dinnerware can be used for microwave heating. Many brands of dinnerware are microwave safe. Check the care information for reference to microwave use for dinnerware and serving pieces. If dinnerware is marked ovenproof, it frequently is safe to use in the microwave oven. However, to be sure, check by conducting microwave dish test previously mentioned.

Several types of glassware and dinnerware are not recommended for use in the microwave oven. Do not use dishes with metallic trim or containers with metal parts. Do not use cups or mugs with glued on handles, as they may fall off with continued heating. Do not use delicate glassware. Although the glassware may be transparent to microwave energy the heat from the food may cause the glassware to crack.

Cookware and Utensils Guide (continued)

Plastics

Plastic dishes, cups and some freezer containers should be used with care in a microwave oven.

Choose plastic containers carefully, as some plastic containers may become soft, melt and may scorch. The majority of plastic dishes, even those designed for use in the microwave oven, are not suitable for cooking foods with high fat or sugar content, or for lengthy cooking times. Most microwave plastic dishes should not be used for longer than 3 to 5 minutes on **P10** power. These dishes, although not suitable for extended cooking, may be used successfully for defrosting or for use on lower power levels.

Cooking Bags designed to withstand boiling, freezing, or conventional heating are microwave safe. Prepare bags according to manufacturer's directions. When cooking by microwave, **DO NOT** use wire twist-ties to close bag. They can act as an antenna and cause arcing (sparks).

DO NOT COOK IN PLASTIC FOOD STORAGE BAGS.

Plastic Wrap such as GLAD WRAP® can be used to cover dishes in most recipes. Over an extended heating time, some disfiguration of the wrap may occur. When removing plastic wrap "covers", as well as any glass lid, be careful to remove it away from you to avoid steam burns.

Loosen plastic but let dish stand, covered.

Jars and Bottles

Jars and bottles can be used to warm food to serving temperature, if the lid is removed first. Cooking should not be done in these containers since most are not heat resistant and during extended heating times, heat from food would cause cracking or breaking.

Metal

Metal cookware or utensils, or those with metallic trim, should **NOT** be used in the microwave. Since microwave energy is reflected by metal, foods in metal containers will not cook evenly. There is also a possibility of "arcing".

Although metal utensils should be avoided in microwave cooking, some metal can be helpful when used correctly.

Aluminum foil can be used safely, if certain guidelines are followed, to prevent overcooking. Small pieces of foil are used to shield areas such as chicken wings, tips of roasts, or other thin parts that cook before the rest of the recipe is finished. Make sure foil is attached securely and doesn't touch sides of oven, otherwise arcing may occur. Foil lined containers, either cardboard or plastic, should **NOT** be used in the microwave oven as arcing could occur.

Metal twist-ties, either paper or plastic coated, should **NOT** be used in the microwave oven. Frozen dinner trays can be used in the microwave, if the container is no deeper than 2 cm and is filled with food. Metal skewers can not be used in microwave ovens as arcing may occur. Wooden skewers are readily available and give the same result.

Shells: Scalloped baking shells are best used during reheating and for short periods of cooking time only.

Thermometers are available for use in microwave ovens. **DO NOT USE CONVENTIONAL MERCURY TYPE CANDY OR MEAT THERMOMETERS** in food while cooking in the microwave oven.

Straw, Wicker and Wood

Straw and wicker baskets may be used in the microwave oven for short periods of time to warm rolls or bread. Large wooden utensils, such as bowls or cutting boards should **NOT** be used for prolonged heating as the microwave energy may cause the wood to become dry and brittle.

Feature Diagram

Glass Tray

1. Do not operate the oven without the Roller Ring and Glass Tray in place.
2. Only use the Glass Tray specifically designed for this oven. Do not substitute another Glass Tray.
3. If Glass Tray is hot, allow to cool before cleaning or placing in water.
4. **Do not** cook directly on Glass Tray. Always place food on a microwave-safe dish, or on a rack set in a microwave-safe dish.
5. If food or utensil on Glass Tray touches oven walls, causing the tray to stop moving, the tray will automatically rotate in opposite direction. This is normal.
6. Glass Tray can rotate in either direction.

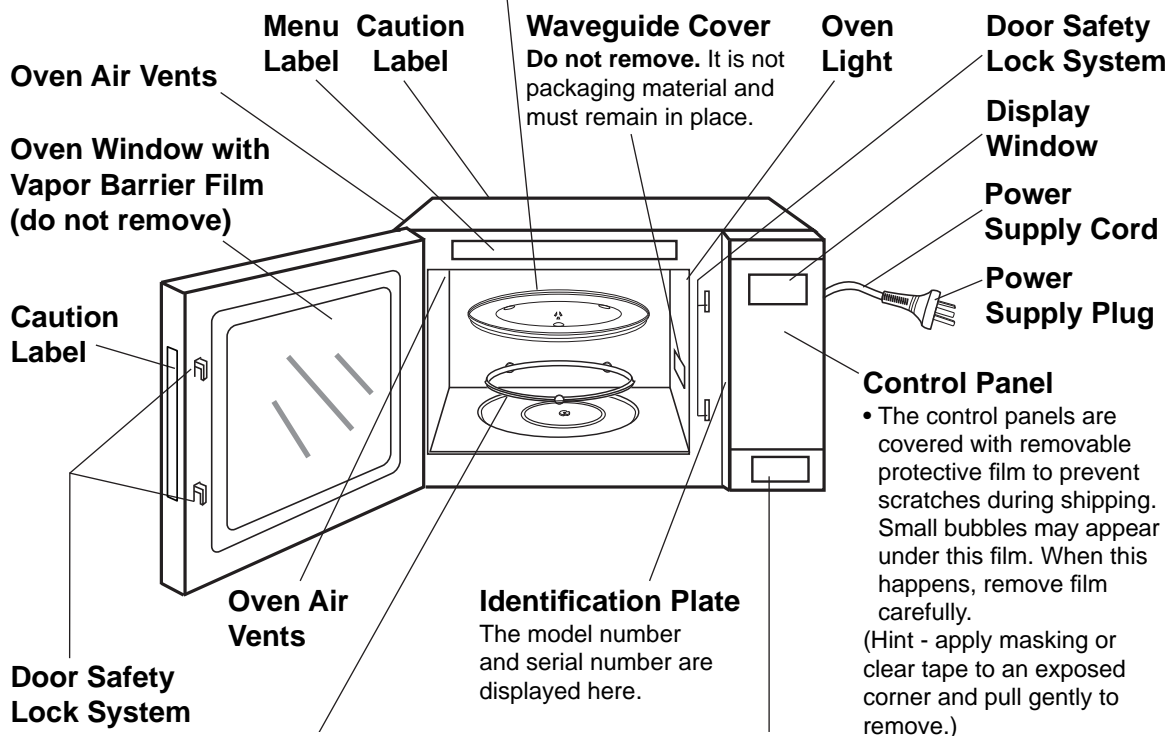

Control Panel

- The control panels are covered with removable protective film to prevent scratches during shipping. Small bubbles may appear under this film. When this happens, remove film carefully. (Hint - apply masking or clear tape to an exposed corner and pull gently to remove.)

Roller Ring

1. The Roller Ring and oven floor should be cleaned frequently to prevent excessive noise and scratching of painted surface.
2. The Roller Ring must always be used together with the Glass Tray for cooking.

Door Release Button

Press to open the door. Opening the door during cooking will stop the cooking process without cancelling the program. Cooking resumes as soon as the door is closed and **Start** Pad is pressed. It is quite safe to open the door at any time during a cooking program and there is no risk of Microwave exposure.

Oven Light:

Oven Light will turn on during cooking and also when door is opened.

NOTE:

The above illustration is for reference only.

Control Panel

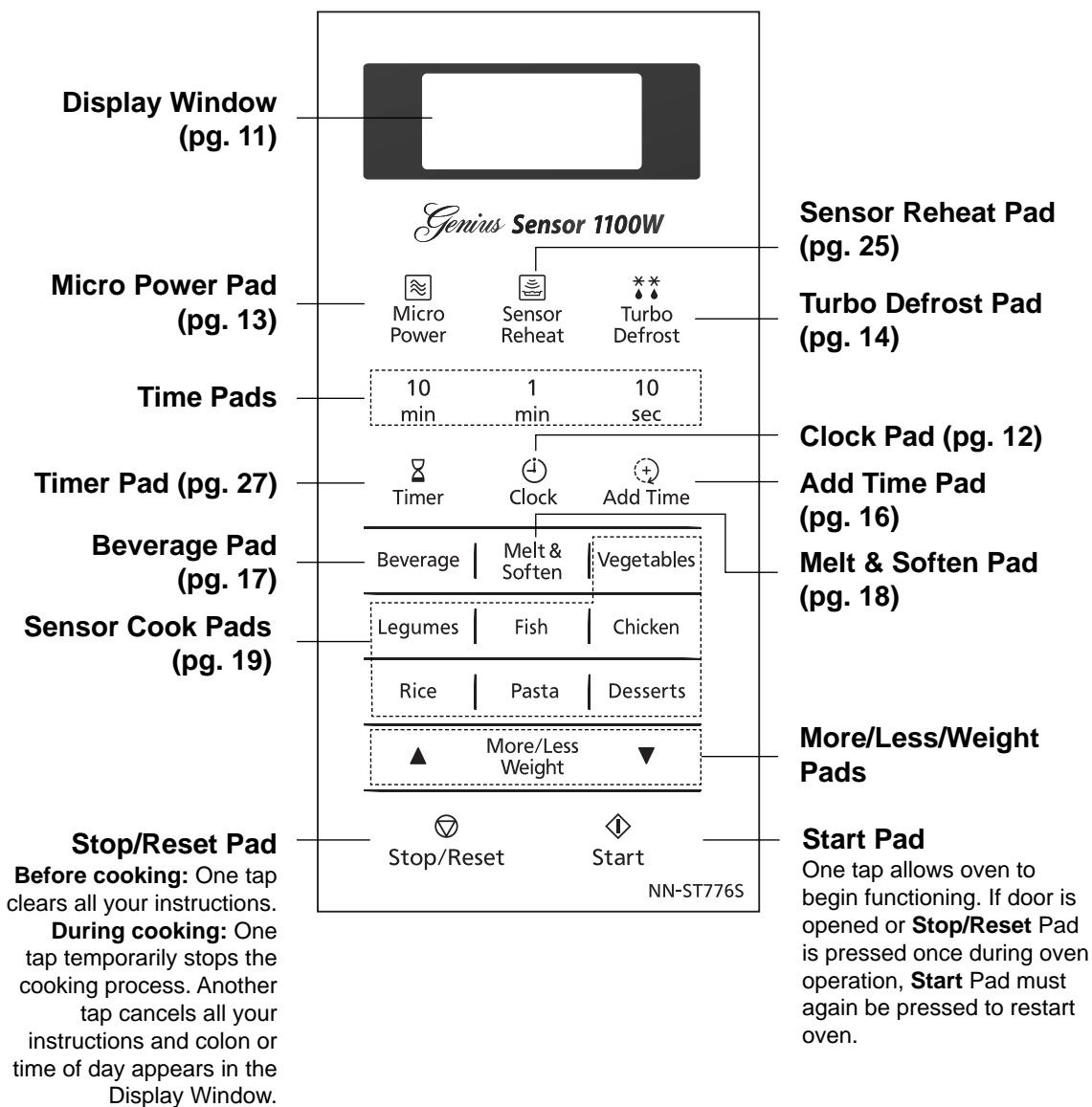

Beep Sound

When pad is pressed correctly, a beep sound will be heard. If a pad is pressed and no beep is heard, the unit does not or cannot accept the instruction. The oven will beep twice between programmed stages. At the end of any complete programme, the oven will beep five times.

NOTE:

If an operation is set and **Start** Pad is not pressed, after 6 minutes, the oven will automatically cancel the operation. The display will revert back to clock or colon mode.

Let's Start To Use Your Oven!

1 Plug in

Plug into a properly earthed electrical outlet. "88:88" appears in the Display Window. (This will immediately cease when any pad is pressed.)



2 Open Door

Open the door and place container with food in a dish on Glass Tray in the oven. Then close the door.

3 Select Power Level

eg. P7
Press **Power Level** Pad four times.
(see page 13 for Micro Power chart)

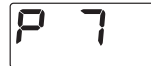

four times

4 Set Time

e.g. 12 minute 20 seconds
Press **Time** Pads

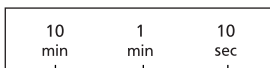

once twice twice



5 Press

Cooking will start.
The time in the Display Window will count down.

Display Window

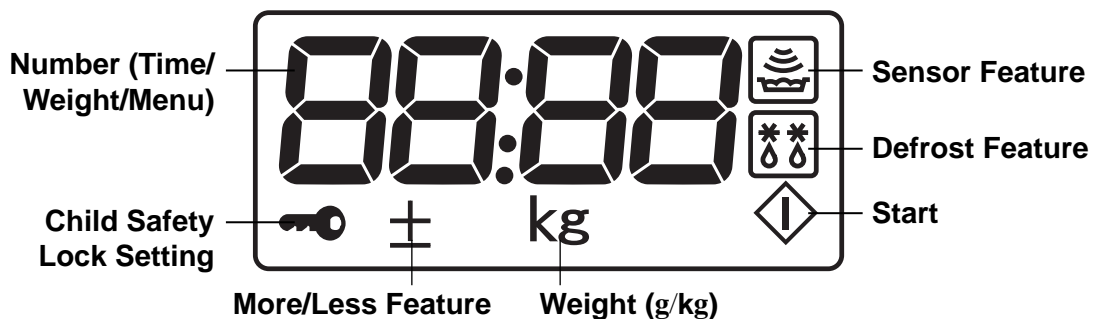

To Set Clock

You can use the oven without setting the clock.

1 Press  **once**

Colon will blink in Display Window.

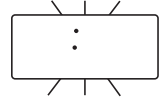

2 Enter Time of Day

Enter time of day using **Time Pads**.

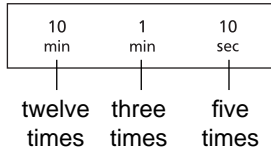

e.g. 12:35



Time appears in the Display Window, colon is blinking.
Verify time of day in the Display Window.

3 Press 

Colon stops blinking; time of day is entered and locked into Display Window.



NOTES:

- Oven will not operate while colon is still blinking.
- To reset time of day, repeat step 1 through 3.
- Clock is a 12 hour display. There isn't a.m. or p.m. setting.
- The clock will keep the time of day as long as oven is plugged in and electricity is supplied.
- Maximum time available is 12:59. Clock is 12 hour only. One o'clock will be displayed as 1:00 not 13:00.

To Use Child Safety Lock

This feature allows you to prevent operation of the oven by a young child; however, the door will open. You can set Child Safety Lock when colon or time of day is displayed.

To set

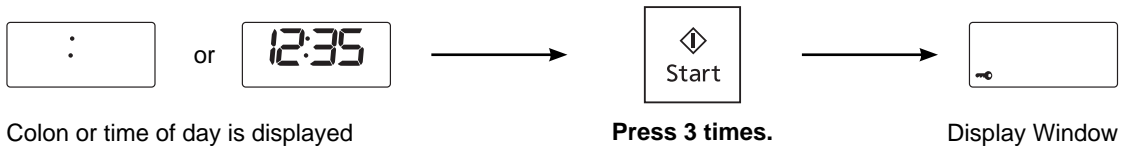

To cancel

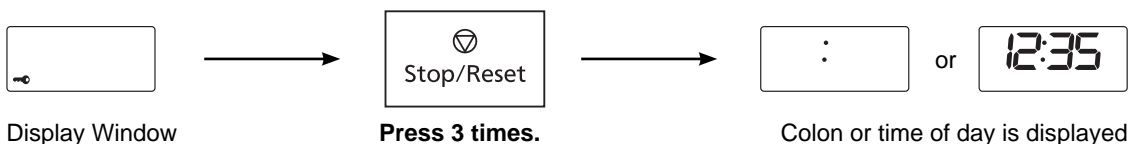

NOTE:

To set or cancel child safety lock, **Start Pad** or **Stop/Reset Pad** must be pressed 3 times within 10 seconds.

To Use Micro Power and Time

1 Select Power Level

Press **Micro Power** Pad until your desired power level appears in the Display Window. (see chart below)
Note: When selecting P10 on the first stage, you can start from step 2.



2 Set Cooking Time

Enter cooking time using **Time** Pads.

Maximum Length of cooking time:

P10 (High power): up to 30 minutes,
 other powers: up to 99 minutes and 50 seconds for a single stage

e.g. 5 minutes

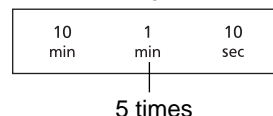

3 Press



Cooking will start.
 The time in the Display Window will count down.

For more than one stage cooking,

Repeat steps 1 & 2 above then press **Start**. The maximum number of stages for cooking is 3. The oven will beep twice between stages. (For further information, refer to page 26)

Micro Power:

The **Power Level** Pad gives you a selection of different power levels representing decreasing amounts of microwave energy, used for cooking foods at different speeds.

e.g. The lower the micro power setting, the more evenly the food cooks, although it will take a little longer.

To select the correct power level for cooking different foods, refer to the chart below.

Press	POWER LEVEL	WATTAGE	DISPLAY	EXAMPLE OF USE
1x	P10	1100 W		Boil water. Cook vegetables, rice, pasta and noodles. Reheating.
2x	P9	1000 W		Cook fresh fruits.
3x	P8	900 W		Cook cakes, desserts. Heat milk.
4x	P7	800 W		Cook pork, whole chicken and chicken pieces.
5x	P6	700 W		Cook beef, lamb and eggs. Melt butter.
6x	P5	600 W		Cook meatloaves. Melt chocolate.
7x	P4	400 W		Cook fish and seafood.
8x	P3	300 W		Defrost meat, poultry and seafood.
9x	P2	200 W		Simmer soups, stews and casseroles (less tender cuts).
10x	P1	100 W		Keep cooked foods warm, simmer slowly.

To Defrost

To Defrost using Turbo Defrost

This feature allows you to defrost meat, poultry and seafood automatically by just setting the weight of the food.



1 Press

until the desired weight appears in the Display Window.

The shape and size of the food will determine the maximum weight the oven can accommodate. The recommended maximum weight of food depends on the oven cavity size. Weight must be programmed in kilograms and tenths of a kilogram (0.1 kg ~ 3.0 kg). For best results, the minimum recommended weight is 0.2 kg.



2 Press

Defrost time appears in the Display Window and begins to count down.

NOTES:

1. After you select the Turbo Defrost feature, you can also press **More/Less/Weight** Pads to select weight before pressing **Start**.
2. The oven will beep once or twice during the total defrosting time. This indicates that food should be turned, broken apart or removed. After attending to food, close door and press **Start** to resume defrosting.
3. For further information, refer to next page.

To Defrost by Micro Power and Time Setting

This feature allows you to defrost meat, poultry and seafood by **P3** and time.

1



2



3



Press 8 times to select P3.
(Defrost power level, refer to page 13)

Set time according to chart on next page.

Press once.

NOTE:

Opening the door and taking out the defrosted parts during the operating time is recommended. Turn over, stir or rearrange the parts which are still in icy.

Defrosting Tips and Techniques

Preparation for Freezing:

1. Heavy-duty plastic wraps, bags and freezer wrap are suitable.
2. Freeze meats, poultry and fish in packages with only 1 or 2 layers of food. To aid in separating layers, place two pieces of wax paper between them.
3. REMOVE ALL AIR and seal securely.
4. LABEL package with type and cut of meat, date and weight.
5. Defrosting times given in the charts are for thoroughly frozen foods (i.e. at least 24 hours in freezer maintained at -18 °C or lower).

Defrosting Technique:

1. Remove from wrapper and set on a defrosting rack in a dish on Glass Tray.
2. On Turbo Defrost, the oven will beep during the defrosting time. At "beep", turn over all meat, poultry, fish and shellfish. Break apart stewing meat, chicken pieces and minced meat. Separate chops and hamburger patties. Shield thin ends of roasts, poultry legs and wings, fat or bones with foil.
3. Throughout the defrosting time, remove any defrosted portions of mince or cubed meat, etc.
4. After defrosting, large roasts may still be icy in the centre. Let stand, 15 to 30 minutes, in refrigerator to complete defrosting.

Defrosting Chart (by setting Micro Power at P3):

FOOD	APPROX. TIME (minutes per 500 g)	INSTRUCTION
MEAT Beef Minced Beef Roast: Topside Beef Tenderloin Chuck or Rump Sirloin, rolled Steak Miscellaneous Pork/Lamb Roast Chops Ribs	 5 - 6 8 - 10 8 - 10 8 - 10 8 - 10 6 - 8 7 - 9 8 - 10 6 - 8 6 - 8	Halfway through the defrost cycle, break apart minced beef, separate chops and remove meat that is defrosted. Turn meat over two to three times during defrosting. Shield edges and unevenly shaped ends of roasts halfway through the defrost cycle. Large roasts may still be icy in centre. Let stand.
POULTRY Chicken whole pieces fillets Duck Turkey	 8 - 10 7 - 9 7 - 9 7 - 9 8 - 10	Turn poultry over two to four times during defrosting. Halfway through the defrost cycle, shield end of drumsticks, wings, breast bones and ends of poultry with foil. Break apart chicken pieces and remove small pieces such as wings, which may be defrosted before larger pieces. Rinse poultry under cold water to remove ice crystals. Let stand 5 to 10 minutes, before cooking.
FISH & SHELLFISH Fish Fillets Whole Fish Crabmeat Lobster Tails Sea Scallops Green Prawns	 8 - 10 7 - 9 6 - 8 6 - 8 6 - 8 6 - 8	Halfway through the defrost cycle, turn whole fish or blocks of fillets over. Also, break apart prawns or scallops. Remove any pieces that are defrosted. Let stand, 5 to 10 minutes, before cooking.

To Use Add Time

This feature allows you to add cooking time at the end of previous cooking.

1 After cooking, press once

To select the Add Time feature

2 Add Cooking Time

Enter cooking time using **Time Pads**.

Maximum cooking time:

High power: up to 30 minutes,
other powers: up to 99 minutes and 50 seconds

e.g. 5 minutes

10 min	1 min	10 sec
-----------	----------	-----------

5 times

3 Press

Time will be added.

The time in the Display Window will count down.

NOTES:

1. This feature is only available for Micro Power function and it is not available for Auto Control function. (Such as Turbo Defrost, Sensor Cook/Reheat, Beverage and Inverter Melt & Soften function.).
2. The Add Time feature will be cancel after 1 minutes, if you don't do any operation after cooking.
3. You also can use Add Time function after the 3-Stage Setting except Standing Time feature and the default Power Level is same as the last stage.

To Use Beverage

This feature allows you to reheat coffee/milk without setting power and time.

1 Press Pad

Press once to reheat coffee, "1" will display in the display window.
Press twice to reheat milk, "2" will display in the display window.

2 Select the weight of beverage by pressing the Pads

For example: To reheat 2 cups coffee - Press **Beverage** Pad once, "1" will display in the display window, then press **More/Less/Weight** (▲ or ▼) Pad twice until desired menu number "1-2" appears in the display window (See below chart).

Press	Menu Number (Press ▲/▼ Pad)	Menu
1x	1-1	1 cup coffee
	1-2	2 cups coffee
2x	2-1	1 cup milk
	2-2	2 cups milk

3 Press Start

Reheat will start. The time in the display window will count down.

NOTES:

1. Use a microwave safe cup.
2. Heated coffee/milk can erupt if not mixed with air. Do not heat coffee/milk in your microwave oven without stirring before and halfway through heating.
3. Care must be exercised not to overheat coffee/milk when using the **Beverage** feature. It is programmed to give proper result when heating 1 cup or 2 cups of coffee/milk, starting from room temperature for coffee and refrigerator temperature for milk. Overheating will cause an increased risk of scalding, or water eruption. Refer to page 6, food, item 5.
4. 1 cup of milk is 200 ml to 250 ml and 1 cup of coffee is 150 ml to 200 ml.

To Use Inverter Melt & Soften

This feature allows you to melt & soften food at the touch of a pad. There is no need to select the power level or cooking time as the microwave does this for you.

1 Press Pad

until the desired food number appears in the display window. (see below chart)

e.g.: Cream Cheese

three times



2 Press Pad

until the desired food weight appears in the display window.

e.g.: 150 g

three times.



Melt & Soften



Menu Number	Menu	Weight						Recommended Containers
		50 g	100 g	150 g	200 g	250 g	300 g	
3	Chocolate	50 g	100 g	150 g	200 g	250 g	300 g	microwave safe dish
4	Butter	50 g	100 g	150 g	200 g	250 g	300 g	microwave safe dish with a lid or plastic wrap
5	Cream Cheese	50 g	100 g	150 g	200 g	250 g	300 g	microwave safe dish
6	Ice Cream	200 g	500 g	1000 g	2000 g	-	-	-

3 Press Pad

Cooking time appears in the Display Window and begins to count down.

For best results on Auto Cook, follow these recommendations:

3. Chocolate

Remove wrapper and place chocolate into a microwave safe dish. Cook without cover. Open the door to **STIR WHEN TWO BEEPS HEARD** during cooking, press **Start** Pad to continue. After heating, stir until completely melted.

Note: Chocolate holds its shape even when softened.

4. Butter

Remove wrapper, cut butter into 2 tbsp cube, and place into a microwave safe dish. Melt with lid or plastic wrap. Stir after cooking.

5. Cream Cheese

Remove wrapper and place in a microwave safe bowl/dish. Soften without cover.

6. Ice Cream

Soften slightly without lid.

NOTE: If food needs more time cooking or weight exceeds range, cook using **P3** for melting or softening.

To Use Sensor Cook

Sensor Cook allows you to cook foods without selecting times and power levels. The sensor detects the heat and humidity generated by the food and cooks your food automatically.

Place food into an appropriate sized dish for the volume of food you are cooking. Cover securely with plastic wrap or a securely fitting lid (do not use any snap closing lids). Plastic dishes are not suitable as a secure seal cannot be achieved and inaccurate cooking may result.

1 Press Desired Food Category Pad

Select and press the appropriate pad for the food you are cooking. The number of category appears in the Display Window.

eg.:

Vegetables

 Press once for Vegetables.
Press twice for Frozen Vegetables.
Menu number appears in the display window.

* More /Less Function:

Preferences for food doneness varies with each individual. After having used Sensor Cook a few times, you may decide you prefer your food cooked to a different doneness. By using the **More/Less/Weight** Pads, the Auto Sensor programmes can be adjusted to cook food for a longer or shorter time. Press **More/Less/Weight** Pads before pressing **Start** Pad.

Press **More** Pad (▲): "+" will display in display window. If you want to return to average cooking result, press **Less** Pad (▼).

Press **Less** Pad (▼): "-" will display in display window. If you want to return to average cooking result, press **More** Pad (▲).

If you are satisfied with the result of the **SENSOR COOK** programme, you don't have to use this pad.



2 Press

The menu number you have selected remains in the display window. Do not stop the oven or open the door during this part of the cooking stage as inaccurate cooking may result. After the heat humidity is detected by the SENSOR, the remaining time appears in the Display Window and begins to count down.

NOTES:

1. The door should not be opened before the time appears in the Display Window.
2. Do not use plastic dishes as a secure seal cannot be achieved and inaccurate cooking may occur.
3. Only cook foods within the weight ranges described and accessories as indicated, see table on page 20-24.
4. To prevent any mistakes during auto sensor programs ensure that the base of the oven and container are dry.
5. To allow for some variations that occur in food, check that food is thoroughly cooked and piping hot before serving.
6. The cavity may become very hot during and after use, please take special care and use kitchen gloves to take out the container when the oven beeps.

To Use Sensor Cook (continued)

For best results, follow these recommendations:

Vegetables

Vegetables

Menu Number	Menu	Recommended Weight	Recommended Containers
7	Vegetables	125 g - 500 g	microwave safe dish with plastic wrap
8	Frozen Vegetables	125 g - 1.0 kg	microwave safe dish with plastic wrap

7. Vegetables

It is suitable for cooking all types of leaf, green and soft varieties of vegetables, including broccoli, squash cauliflower, cabbage, asparagus, beans, celery, zucchini, spinach, capsicum or a mixture of these. All vegetables should be trimmed or prepared and cut into evenly sized pieces. Clean the vegetables and place them in a microwave safe container, add 1 tablespoon to ¼ cup of water to vegetables if dehydrated or a softer cooked texture is desired. Butter, herbs, etc., may be added before heating, but do not salt vegetables until serving. Cover dishes securely with plastic wrap and place container at the center of the glass tray. Select the program then press **Start**. Open the door to **STIR WHEN TWO BEEPS HEARD** during cooking, press **Start** Pad to continue. At the end of cooking, stir larger quantities of vegetables. Let stand, covered, for 2 to 3 minutes.

8. Frozen Vegetables

It is suitable for all types of frozen vegetables. Put them in a microwave safe container. Do not use plastic dishes. Best results are achieved if large quantities are placed in a single layer. Add 1 tablespoon to ¼ cup water to vegetables, if desired. Butter, herbs etc. may be added before heating, but do not add salt until serving. Cover dishes securely with plastic wrap and place container at the center of the glass tray. Select the program then press **Start**. Open the door to **STIR WHEN TWO BEEPS HEARD** during cooking, press **Start** Pad to continue. At the end of the cooking, stir vegetables and let stand, covered, for 2 to 3 minutes.

Legumes

Legumes

Menu Number	Menu	Recommended Weight	Recommended Containers
9	Legumes	1 cup - 4 cups	microwave safe dish with plastic wrap
10	Potatoes	125 g - 1.0 kg	microwave safe dish with plastic wrap

9. Legumes

It is Suitable for cooking chickpeas, split peas dried beans and peas. Cover legumes with cold water and soak overnight, drain. Place legumes and boiling water into an appropriate sized microwave safe container. (See table for quantities)

Amount of Legumes	1 cup	2 cups	3 cups	4 cups
Amount of Boiling Water	3 cups	4 cups	6 cups	8 cups
Dish Size	2 litre	3 litre	4 litre	4 litre

Cover dishes securely with plastic wrap and place container at the center of the glass tray. Select the program then press **Start**. Open the door to **STIR AND REMOVE THE PLASTIC WRAP WHEN TWO BEEPS HEARD** during cooking, press **Start** Pad to continue. At the end of cooking, allow legumes to stand for 5 minutes if required. If food needs more time cooking, cooking using **P6**.

10. Potatoes

It is suitable for cooking root vegetables such as potatoes, sweet potatoes, pumpkin, onions, swede, carrots, turnip and beetroot. All vegetables should be trimmed or prepared and cut into even sized pieces. Clean the vegetables and place them in a microwave safe container, add 1 tablespoon to ¼ cup of water to vegetables if dehydrated or a softer cooked texture is desired. If desired, butter, herbs etc. may be added, but do not add salt until after cooking. Cover dishes securely with plastic wrap and place container at the center of the glass tray. Select the program then press **Start**. Open the door to **STIR WHEN TWO BEEPS HEARD** during cooking, press **Start** Pad to continue. At the end of the cooking, stir larger quantities of vegetables. Let stand, covered, for 2 to 3 minutes.

To Use Sensor Cook (continued)

Fish

Fish

Menu Number	Menu	Recommended Weight	Recommended Containers
11	Steam Fish	125 g - 500 g	microwave safe dish with plastic wrap

11. Steam Fish

It is suitable for cooking whole fish and fish fillets (thickness of fish should not be more than 3 cm). Select fish suitable for microwave cooking and place in a single layer in a shallow microwave safe dish, with skinside down. Add butter, spices, herbs, or lemon juice to flavour. Overlap thin edges of fillets to prevent overcooking. Shield the eye and tail area of whole fish with small amounts of aluminum foil to prevent overcooking. Cover dishes securely with plastic wrap and place container at the center of the glass tray. Select the program then press **Start**. Allow large amounts of fish to stand for 3 to 5 minutes after cooking before serving.

Chicken

Chicken

Menu Number	Menu	Recommended Weight	Recommended Containers
12	Steam Chicken Pieces	400 g - 1.0 kg	microwave safe dish with plastic wrap or fitted lid

12. Steam Chicken Pieces

It is suitable for cooking chicken pieces, such as wings, thighs, legs, breast fillets. Chicken pieces should be completely thawed before cooking. Pierce the chicken pieces. Marinate chicken pieces before cooking for added flavour and colour. Put the prepared chicken pieces onto a microwave safe dish. Cover securely with plastic wrap or fitted lid and place container at the center of the glass tray. Select the program then press **Start**. Open the door to **STIR WHEN TWO BEEPS HEARD** during cooking, press **Start** Pad to continue. Let stand 5 to 10 minutes at the end of cooking.

To Use Sensor Cook (continued)

Rice

Rice

Menu Number	Menu	Recommended Weight	Recommended Containers
13	Rice	1 cup - 2½ cups	microwave safe dish with plastic wrap
14	Curries	250 g - 750 g (meat weight only)	microwave safe dish with plastic wrap
15	Quinoa	¼ cup - 1 cup	microwave safe dish with plastic wrap

13. Rice

It is suitable for cooking short and long grain rice including specialty rices. It is not suitable for cooking brown rice or wild rice. Place rice with water at room temperature in a suitable microwave safe dish. We recommend the following proportions of rice to cold tap water:

Rice	1 cup	1½ cups	2 cups	2½ cups
Water	1½ cups	2½ cups	3½ cups	4½ cups
Dish Size	3 litre	3 litre	4.5 litre	4.5 litre

It may be necessary to adjust the water to your personal preference. Soak in water for 10 - 15 minutes. Always allow at most ½ depth of volume for evaporation to prevent boiling over. Do not cook rice in plastic dishes as incorrect cooking times may result. Cover securely with plastic wrap and place container at the center of the glass tray. Select the program then press **Start**. Open the door to **STIR AND REMOVE THE PLASTIC WRAP WHEN TWO BEEPS HEARD** during cooking, press **Start** Pad to continue. At the end of the cooking, let stand 5 to 10 minutes, covered.

14. Curries

It is suitable for cooking curries. See chart below for quantities to use.

Serves	2	4	6
Weight of meat	250 g	500 g	750 g
Amount of liquid (coconut milk, stock)	375 ml	500 ml	750 ml
Weight of hard vegetables	200 g	400 g	600 g

Cut meat and vegetables into even size pieces. Place curry paste, meat, onion and hard vegetable into a suitable size casserole dish, do not use plastic dishes. Cover securely with plastic wrap and place container at the center of the glass tray. Select curries then **Start**. Open the door to **STIR AND ADD REMAINING INGREDIENTS INCLUDING LIQUID WHEN TWO BEEPS HEARD** during cooking, press **Start** Pad to continue. At the end of cooking time, allow to stand for 5-10 minutes. Serve with rice.

15. Quinoa

It is suitable for cooking quinoa. Place quinoa in a microwave safe casserole dish. Add 2 parts water to 1 part quinoa. Use the above chart as a guide:

Quinoa	¼ cup	½ cup	¾ cup	1 cup
Tap water	½ cup	1 cup	1½ cups	2 cups
Dish Size	2 litre	2.5 litre	3 litre	3.5 litre

Allow at least ½ depth of volume for evaporation to prevent boiling over. Soak in water for 10 - 15 minutes. Cover securely with plastic wrap and place container at the center of the glass tray. Select the program then press **Start**. Open the door to **STIR WHEN TWO BEEPS HEARD** during cooking, press **Start** Pad to continue. At the end of the cooking, let stand 10-15 minutes.

To Use Sensor Cook (continued)

Pasta

Pasta

Menu Number	Menu	Weight	Recommended Containers
16	Fresh Pasta	125 g - 625 g	microwave safe dish with plastic wrap
17	Dried Pasta	125 g - 500 g	microwave safe dish with plastic wrap

16. Fresh Pasta

It is suitable for cooking fresh pasta such as fettuccine, tagliatelle, tortellini, ravioli and agnolotti. (Gnocchi should be cooked by manual MICRO POWER.) Place pasta in an appropriate size microwave safe dish with boiling water. Use the above chart as a guide:

Pasta	150 g	250 g	350 g	500 g	625 g
Boiling Water	4 cups	5 cups	6 cups	8 cups	8 cups
Dish Size	3 litre	3 litre	4 litre	4 litre	5 litre

Always allow at most ½ depth of volume for evaporation to prevent boiling over. Add 1 tablespoon of oil, if desired, before cooking to prevent pasta from sticking together. Cover securely with plastic wrap and place container at the center of the glass tray. Select the program then press **Start**. Open the door to **STIR AND REMOVE THE PLASTIC WRAP WHEN TWO BEEPS HEARD** during cooking, press **Start** Pad to continue. At the end of the cooking, cover and let stand for 5 to 10 minutes, if required, before draining.

17. Dried Pasta

It is suitable for cooking dried pasta such as spaghetti, fettuccine, macaroni, penne, spiral and various pasta shapes. Place pasta in an appropriate size microwave safe dish with boiling water. Use the following as a guide:

Pasta	150 g	250 g	350 g	500 g
Boiling Water	4 cups	5 cups	6 cups	8 cups
Dish Size	3 litre	3 litre	4 litre	4 litre

Always allow at most ½ depth of volume for evaporation to prevent boiling over. Add 1 tablespoon of oil, if desired, before cooking to prevent pasta from sticking together. Cover securely with plastic wrap and place container at the center of the glass tray. Select the program then press **Start**. Open the door to **STIR AND REMOVE THE PLASTIC WRAP WHEN TWO BEEPS HEARD** during cooking, press **Start** Pad to continue. At the end of the cooking, cover and let stand for 5 to 10 minutes, if required, before draining.

To Use Sensor Cook (continued)

Desserts

Desserts

Menu Number	Menu	Weight	Recommended Containers
18	Desserts	1 Serv. - 4 Serv.	microwave safe dish

18. Desserts

It is suitable for cooking individual steamed sponge puddings. Use packet mixes available from supermarkets or individual recipes. Not suitable for heavy fruit type puddings. See chart below for quantities.

	2 Serv.	4 Serv.
self raising flour	½ cup	1 cup
cocoa powder	½ tablespoon	1 tablespoon
caster sugar	⅓ cup	⅔ cup
milk	¾ cup	1½ cup
vanilla essence	½ teaspoon	1 teaspoon
chocolate	25 g	50 g
butter	50 g	100 g
brown sugar	¾ cup	1½ cup
cocoa, extra	1 tablespoon	2 tablespoons
water	¼ cup	½ cup

Sift flour and cocoa into a bowl. Add sugar, milk and vanilla essence. Mix well and set aside. Melt chocolate and butter in a separate microwave safe container and pour it into the mixture while hot. Mix well. Combine brown sugar, cocoa and water in a jug. Spread all the mixture into base of a 2-litre casserole dish. Select the program then press **Start**. **DO NOT USE PLASTIC WRAP OR LID.**

To Use Sensor Reheat

Sensor Reheat allows you to reheat foods without selecting times and power levels. The sensor detects the heat and humidity generated by the food and reheat your food automatically.

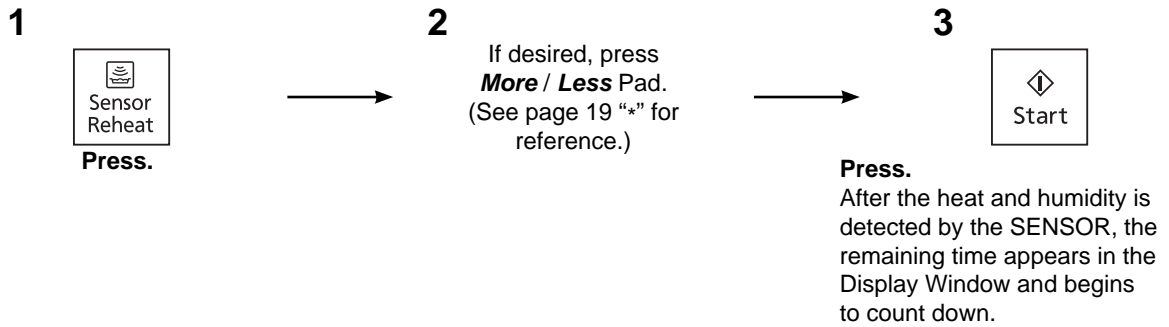

For best results on Sensor Reheat, follow these recommendations:

1. Reheating by Sensor is suitable for pre-cooked foods. There is a setting for frozen and refrigerator temperature or room temperature foods. It is suitable for casseroles, plated meals, soup, stews, pasta dishes (except lasagne) and canned foods.
2. Food being reheated should weigh between 125 g and 1.0 kg. For foods weighing less than 125 g and more than 1.0 kg, use a manual micro power setting.
3. **Do not** reheat bread or pastry products (raw or uncooked), or beverages.
4. **Do not** use if oven cavity is warm (from previously cooked foods).
5. Cover foods securely with plastic wrap. (Do not use any snap closing lids.)
6. The door should not be opened before the time appears in the Display Window.
7. During the heating time, the oven will ‘beep’ and prompt you to stir/rearrange the food. There is no need to recover if not required.
8. All foods should have a covered stand time of at least 3 to 5 minutes.

INGREDIENT CONVERSION CHART

INGREDIENT CONVERSION CHART			
¼ cup	60 ml	¼ teaspoon	1 ml
⅓ cup	85 ml	½ teaspoon	2 ml
½ cup	125 ml	1 teaspoon	5 ml
⅔ cup	165 ml	2 teaspoons	10 ml
¾ cup	190 ml	3 teaspoons	15 ml
1 cup	250 ml	1 tablespoon	20 ml
1¼ cups	310 ml	1½ tablespoons	30 ml
1½ cups	375 ml	2 tablespoons	40 ml
2 cups	500 ml	3 tablespoons	60 ml
3 cup	750 ml	4 tablespoons	80 ml
3½ cups	875 ml		
4 cups	1 litre		
6 cups	1.5 litre		
8 cups	2 litre		

All recipes are tested using standard measurement that appear in the above chart.

3-Stage Setting

This feature allows you to program 3 Stage of cooking continuously.

e.g.: Continually set [P10] 2 minutes, [P7] 3 minutes and [P4] 2 minutes.

1. Press once to select "P10".



Once

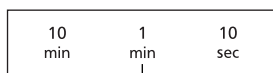

twice



4 times



2. Set as 2 minutes using **Time Pads.**

3. Press 4 times to select "P7".

4. Set as 3 minutes using **Time Pads.**

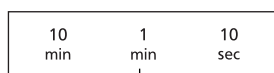

3 times



5. Press 7 times to select "P4".



7 times



6. Set as 2 minutes using **Time Pads.**

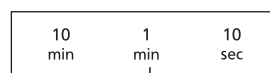

twice



7. Press once. The time will count down at the first stage in the display window.



Once

NOTES:

1. When operating, two beeps will sound between each stage.
2. When selecting P10 on the first stage, you can skip step 1.
3. This feature is only available for manual cooking and it is not available for Auto Control function. (Such as Turbo Defrost, Sensor Cook/Reheat, Beverage and Inverter Melt & Soften function.)

To Use Timer

This feature allows you to program standing after cooking is completed and to program the oven as a minute or a second timer or program delay start.

To Use as a Kitchen Timer

Press once.

Set desired amount of time.
(up to 99 minutes and 50 seconds)

Press Start.
Time will count down without oven operating.

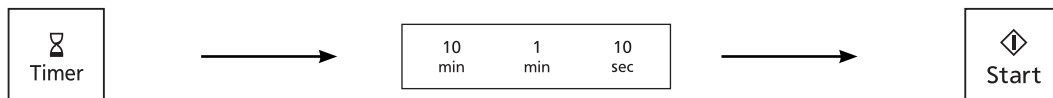

To Set Standing Time

Press once.

Set desired amount of standing time.
(up to 99 minutes and 50 seconds)

Press Start.
Cooking will start. After cooking, standing time will count down without oven operating.

Set the desired cooking programme, up to 2 stages. (see page 13)

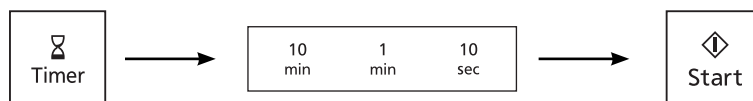

To Set Delay Start

Press once.

Set desired amount of delay time.
(up to 99 minutes and 50 seconds)

Press Start.
Delayed time will count down without oven operating. Then cooking will start.

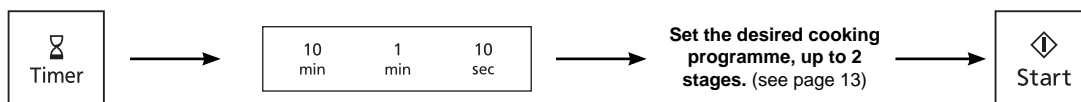

NOTES:

1. If oven door is opened during the Standing Time, Delay Start or Kitchen Timer, the time in the Display Window will continue to count down.
2. Delay Start/Standing Time cannot be programmed before/after any Auto Control function (Such as Turbo Defrost, Sensor Cook/Reheat, Beverage and Inverter Melt & Soften function.). This is to prevent the standing temperature of the food from rising before defrosting or cooking begins. A change in the starting temperature could cause inaccurate results and/or food may deteriorate.
3. When using Standing time or Delay Start, it's up to 2 Power stages.

Before Requesting Service

THESE THINGS ARE NORMAL

The oven causes interference with my TV.

Some radio, TV, Wi-Fi, cordless telephone, baby monitor, blue tooth or other wireless equipment interference might occur when you cook with the microwave oven. This interference is similar to the interference caused by small appliances such as mixers, vacuums, blow dryers, etc. It does not indicate a problem with your oven.

Steam accumulates on the oven door and warm air comes from the oven vents.

During cooking, steam and warm air are given off from the food. Most of the steam and warm air are removed from the oven by the air which circulates in the oven cavity. However, some steam will condense on cooler surfaces such as the oven door. This is normal.

I accidentally ran my microwave oven without any food in it.

Running the oven empty for a short time will not damage the oven. However, we do not recommend this.

PROBLEM

POSSIBLE CAUSE

REMEDY

Oven will not turn on.

The oven is not plugged in securely.

Remove plug from outlet, wait 10 seconds and re-insert.

Circuit breaker or fuse is tripped or blown.

Reset circuit breaker or replace fuse.

There is a problem with the outlet.

Plug another appliance into the outlet to check if the outlet is working.

Oven will not start cooking.

The door is not closed completely.

Close the oven door securely.

Start Pad was not pressed after programming

Press **Start** Pad.

Another program has already been entered into the oven.

Press **Stop/Reset** Pad to cancel the previous program and program again.

The program has not been entered correctly.

Program again according to the Operating Instructions.

Stop/Reset Pad has been pressed accidentally.

Program oven again.

When the oven is turning on, there is noise coming from Glass Tray.

The roller ring and oven bottom are dirty.

Clean these parts according to care of your oven (See next page).

"**lc**" appears in the **Display Window**.

The Child Lock was activated by pressing **Start** Pad 3 times.

Deactivate Lock by pressing **Stop/Reset** Pad 3 times.

"H97", "H98" or "H00" appears in the display window.

The display indicates a problem with microwave generation system.

Contact the specified service centre.

If it seems there is a problem with the oven, contact an authorized Service Centre.

Care of your Microwave Oven

BEFORE CLEANING:

Unplug at socket of the oven. If impossible, leave oven door open to prevent oven from accidentally turning on.

AFTER CLEANING:

Be sure to replace the Roller Ring and Glass Tray in the proper position and press **Stop/Reset** Pad to clear the Display Window.

Inside of the oven:

Wipe with a damp cloth. Mild detergent may be used if the oven gets very dirty. The use of harsh detergent or abrasives is not recommended.

Glass Tray:

Remove and wash in warm soapy water or in a dishwasher. If grease accumulates, clean with a nonabrasive nylon mesh scouring pad and a non-abrasive cleanser.

Outside oven surfaces and back vents.

Clean with a damp cloth. To prevent damage to the operating parts inside the oven, water should not be allowed to seep into ventilation openings.

Control Panel:

- May be covered with removable protective film to prevent scratches during shipping. Small bubbles may appear under this film. When this happens, remove film carefully. (*Hint - apply masking or clear tape to an exposed corner and pull gently to remove.*)
- If it becomes wet, clean with a soft, dry cloth. Do not use harsh detergents or abrasives on the Control Panel.

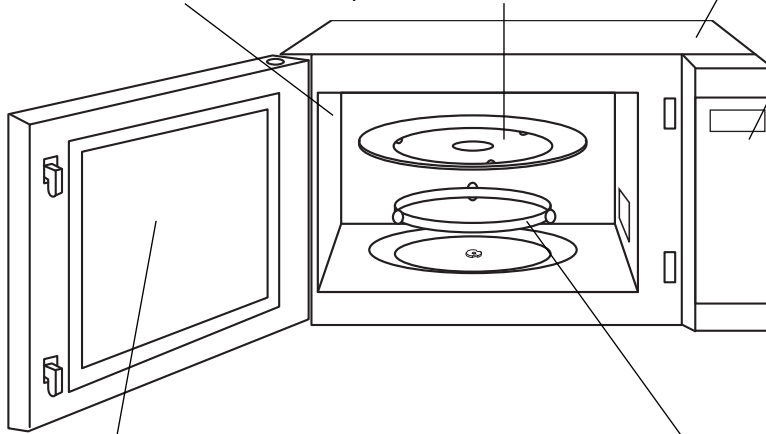

Oven Door:

Wipe with a soft cloth when steam accumulates inside or around the outside of the oven door. This may occur when the microwave oven is operated under high humidity conditions and in no way indicates a malfunction of the unit or of microwave leakage.

Roller Ring and oven cavity floor:

Wipe the bottom surface of the oven with mild detergent water or window cleaner and dry. Roller Ring may be washed in mild soapy water or dishwasher. These areas should be kept clean to avoid excessive noise.

Note:

1. The oven should be cleaned regularly and any food deposits removed. Failure to maintain the oven in a clean condition could lead to deterioration of the surface that could adversely affect the life of the appliance and possibly result in a hazardous situation.
2. When it becomes necessary to replace the oven light, please consult a dealer to have it replaced.
3. After each time the unit is used it should be wiped down to remove any moisture that has accumulated inside the cavity.
4. The appliance shall not be cleaned with a steam cleaner.

Technical Specifications

Power Supply:	230 - 240 V, 50 Hz
Power Consumption*:	4.4 A 1000 W
Power Requirement: (Maximum)	7.5 A 1700 W
Output*:	1100 W
Outside Dimensions (W x H x D):	555 mm (W) x 304 mm (H) x 493 mm (D)
Oven Cavity Dimensions (W x H x D):	418 mm (W) x 228 mm (H) x 470 mm (D)
Overall Cavity Volume:	44 L
Glass Tray Diameter:	Ø380 mm
Operating Frequency:	2450 MHz
Uncrated Weight:	Approx. 14.3 kg

Trim Kit (Australia and New Zealand only)

Model Number	NN-TK712SSQP
Outside Dimensions	596 mm (W) x 410 mm (H)
Cabinet Opening	600 mm (W) x 395 mm (H) x 533 mm (D)

* IEC Test Procedure

Specifications subject to change without notice.

As for the voltage requirement, the production month, country and serial number, please refer to the identification plate on the microwave oven.

Panasonic Warranty (For Australia)

Home Appliance 12 Month Warranty from Date of Purchase

1. Subject to the conditions of this warranty Panasonic or its Authorised Service Centre will perform necessary service on the product without charge for parts or labour, if in the opinion of Panasonic, the product is found to be faulty within the warranty period. For Communications products (i.e. Cordless Phones, etc) the genuine battery(s) has a 3 month warranty.
2. This warranty only applies to Panasonic products purchased in Australia and sold by Panasonic Australia or its Authorised Distributors or Dealers and only where the products are used and serviced within Australia or its territories. Warranty cover only applies to service carried out by a Panasonic Authorised Service Centre and only if valid proof of purchase is presented when warranty service is requested.
3. This warranty only applies if the product has been installed and used in accordance with the manufacturer's recommendations (as noted in the operating instructions) under normal use and reasonable care (in the opinion of Panasonic). The warranty covers normal domestic use only (also Clip & Trim Professional use) and does not cover damage, malfunction or failure resulting from use of incorrect voltages, incorrect installation, accident, misuse, neglect, build-up of dirt or dust, abuse, maladjustment of customer controls, mains supply problems, thunderstorm activity, infestation by insects or vermin, tampering or repair by unauthorised persons (including unauthorised alterations), exposure to abnormally corrosive conditions or any foreign object or matter having entered the product.
4. This warranty does not cover the following items unless the fault or defect existed at the time of purchase:
 - (a) Cabinet Parts
 - (b) Microwave Oven Plates.
 - (c) User replaceable Batteries
 - (d) Kneader Mounting Shaft, Shaver Heads, Cutters, Foils, Blades
 - (e) Accessories
 - (f) Noise or vibration that is considered normal
5. To claim warranty service, when required, you should:
 - Contact Panasonic's Customer Care Centre on 132600
 - Send or take the product to a Panasonic Authorised Service Centre together with your purchase receipt as a proof of purchase date. Please note that freight and insurance to and / or from your nearest Authorised Service Centre must be arranged by you.
6. The warranties hereby conferred do not extend to, and exclude, any costs associated with the installation, de-installation or re-installation of a product, including costs related to the mounting, de-mounting or remounting of any screen, (and any other ancillary activities), delivery, handling, freighting, transportation or insurance of the product or any part thereof or replacement of and do not extend to, and exclude, any damage or loss occurring by reason of, during, associated with, or related to such installation, de-installation, re-installation or transit.

Panasonic Authorised Service Centres are located in major metropolitan areas and most regional centres of Australia, however, coverage will vary dependant on product. For advice on exact Authorised Service Centre locations for your product, please telephone our Customer Care Centre on 132600.

In addition to your rights under this warranty, Panasonic products come with consumer guarantees that cannot be excluded under the Australian Consumer Law. If there is a major failure with the product, you can reject the product and elect to have a refund or to have the product replaced or if you wish you may elect to keep the goods and be compensated for the drop in value of the goods. You are also entitled to have the product repaired or replaced if the product fails to be of acceptable quality and the failure does not amount to a major failure.

If there is a major failure in regard to the product which cannot be remedied then you must notify us within a reasonable period by contacting the Panasonic Customer Care Centre. If the failure in the product is not a major failure then Panasonic may choose to repair or replace the product and will do so in a reasonable period of time from receiving notice from you.

THIS WARRANTY CARD AND THE PURCHASE DOCKET (OR SIMILAR PROOF OF PURCHASE) SHOULD BE RETAINED BY THE CUSTOMER AT ALL TIMES

If you require assistance regarding warranty conditions or any other enquiries, please visit the **Panasonic Australia** website www.panasonic.com.au or contact by phone on **132 600**
If phoning in, please ensure you have your operating instructions available.

Panasonic Australia Pty. Limited

ACN 001 592 187 ABN 83 001 592 187

1 Innovation Road, Macquarie Park NSW 2113
www.panasonic.com.au

PRO-031-F01 Issue: 6.0

02-10-2013

Panasonic Warranty (For New Zealand)

Home Appliance 12 Month Warranty from Date of Purchase

1. Subject to the conditions of this warranty Panasonic or its Authorised Service Centre will perform necessary service on the product without charge for parts or labour, if in the opinion of Panasonic, the product is found to be faulty within the warranty period. For Line Communications products (i.e. Cordless Phones, etc) the genuine battery(s) has a 3 month warranty.
2. This warranty only applies to Panasonic products purchased in New Zealand and sold by Panasonic New Zealand or its Authorised Distributors or Dealers and only where the products are used and serviced within New Zealand or its territories. Warranty cover only applies to service carried out by a Panasonic Authorised Service Centre and only if valid proof of purchase is presented when warranty service is requested.
3. This warranty only applies if the product has been installed and used in accordance with the manufacturer's recommendations (as noted in the operating instructions) under normal use and reasonable care (in the opinion of Panasonic). The warranty covers normal domestic use only (also Clip & Trim Professional use) and does not cover damage, malfunction or failure resulting from use of incorrect voltages, incorrect installation, accident, misuse, neglect, build-up of dirt or dust, abuse, maladjustment of customer controls, mains supply problems, thunderstorm activity, infestation by insects or vermin, tampering or repair by unauthorised persons (including unauthorised alterations), exposure to abnormally corrosive conditions or any foreign object or matter having entered the product.
4. This warranty does not cover the following items unless the fault or defect existed at the time of purchase:
 - (a) Cabinet Parts
 - (b) Microwave Oven cook plates.
 - (c) User replaceable Batteries from wear and tear in normal use
 - (d) Kneader mounting shaft unit and Heads, Cutters, Foils, Blades and other accessories.
 - (e) Noise or vibration that is considered normal
5. To claim warranty service, when required, you should:
 - Telephone Panasonic's Customer Care Centre on 09 2720178 or visit our website referred to below and use the Service Centre Locator for the name/address of the nearest Authorised Service Centre.
 - Send or take the product to a Panasonic Authorised Service Centre together with your proof of purchase receipt as a proof of purchase date. Please note that freight and insurance to and / or from your nearest Authorised Service Centre must be arranged by you.
6. The warranties hereby conferred do not extend to, and exclude, any costs associated with the installation, de-installation or re-installation of a product, including costs related to the mounting, de-mounting or remounting of any screen, (and any other ancillary activities), delivery, handling, freighting, transportation or insurance of the product or any part thereof or replacement of and do not extend to, and exclude, any damage or loss occurring by reason of, during, associated with, or related to such installation, de-installation, re-installation or transit.

Panasonic Authorised Service Centres are located in major metropolitan areas and most regional centres of New Zealand, however, coverage will vary dependant on product. For advice on exact Authorised Service Centre locations for your product, please telephone our Customer Care Centre on 09 2720178 or visit our website and use the Service Centre Locator.

Unless otherwise specified to the consumer the benefits conferred by this express warranty are additional to all other conditions, warranties, guarantees, rights and remedies expressed or implied by the Consumer Guarantees Act of New Zealand and all other obligations and liabilities on the part of the manufacturer or supplier and nothing contained herein shall restrict or modify such rights, remedies, obligations and liabilities.

**THIS WARRANTY CARD AND THE PURCHASE DOCKET (OR SIMILAR PROOF OF PURCHASE)
SHOULD BE RETAINED BY THE CUSTOMER AT ALL TIMES**

If you require assistance regarding warranty conditions or any other enquiries, please visit the **Panasonic New Zealand** website www.panasonic.co.nz or contact by phone on **09 2720178**
If phoning in, please ensure you have your operating instructions available.

Panasonic New Zealand Customer Care Centre











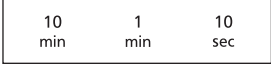





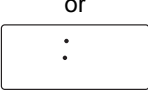

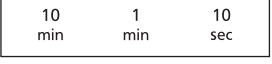

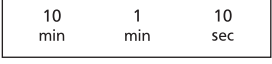

Phone: 09 2720178

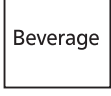
Fax: 09 2720129





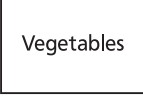





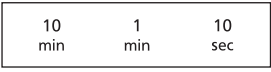

Email: customerservice@nz.panasonic.com

Website: www.panasonic.co.nz/support

Quick Guide to Operation

Feature	How to Operate		
To Set Clock <small>(page 12)</small>			
	Press once.	Set time of day. (Max 12:59)	Press once.
To Set/Cancel Child Safety Lock <small>(page 12)</small>	To set  3 times.  Display	To cancel  3 times.  or  Display	
To Cook/Reheat/Defrost by Micro Power and Time Setting <small>(page 13)</small>			
	Select power.	Select cooking time.	Press once
To Use Turbo Defrost Pad <small>(page 14)</small>			
	Press to select the desired weight		Press once
	After you select the Turbo Defrost feature, you can also press More/Less/Weight Pads to select weight before pressing Start .		
To Use Add Time Pad <small>(page 16)</small>	At the end of program. 		
	Press once	Set time.	Press once
To Cook using "Beverage" Pad <small>(page 17)</small>			
	Press to select coffee or milk.	Press to select 1 cup or 2 cups.	Press once
To Cook using "Melt & Soften" Pad <small>(page 18)</small>			
	Press until desired menu number appears.	Set weight	Press once
To Cook using "Sensor Cook" Pads <small>(page 19)</small>	e.g. Frozen Vegetables 		
	Press twice.	optional	Press once

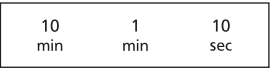
Quick Guide to Operation (continued)

Feature	How to Operate		
To Cook using “Sensor Reheat” Pad (see page 25)	 Sensor Reheat Press once	 More/Less Weight optional	 Start Press once
To Use Kitchen Timer (see page 27)	 Timer Press once	 Set time.	 Start Press once
To Set Standing Time (see page 27)	Set the desired cooking programme, up to 2 stages. (see page 13)  Timer Press once.	 Set time.	 Start Press once.
To Set Delay Start (see page 27)	 Timer Press once.	 Set time.	Set the desired cooking programme, up to 2 stages. (see page 13)  Start Press once.

Microwaves penetrate the surface of the food to a depth of about two to three centimetres and then the heat is gradually conducted in a random pattern. Some parts of food matter cook faster than others. Special microwave techniques are used to promote

fast and even cooking. Some of these techniques are similar to those used in conventional cooking, but because microwaves produce heat very quickly the following techniques are extremely important. It's a must for you to be familiar with the following tips.

Food Characteristics

Size and Quantity

Small portions cook faster than large portions. As you increase the quantity of food you put into the microwave oven, you must also increase your cooking time. The microwave oven has the same power regardless of quantity; thus the power is divided between more items and so it takes longer to cook. As a general guide, if you double the quantity of food suggested in the recipe, add half the time suggested again.

Liquid Content

Low moisture foods take a shorter time to cook than foods with a lot of moisture.

Shape

Uniform sizes cook more evenly. To compensate for irregular shapes, place thin pieces towards the centre of the dish and thicker pieces towards the outer edge of the dish.

Bone and Fat

Bones conduct heat and cause the meat next to them to be heated more quickly. Large amounts of fat absorb microwave energy and the meat next to these areas may overcook.

Starting Temperature

Food which has been sitting at room temperature takes less time to cook than refrigerated or frozen food.

Density and Composition

Porous, airy foods (cakes and breads) take less time to cook than heavy compacted foods (meat and vegetables). Recipes high in fat and sugar content cook more quickly.

Soups

Use a bowl and stir before heating and at least once through reheat time and again at the end.

Techniques for Preparation

Timing

A range of cooking times is given in each recipe for two reasons. First, to allow for the uncontrollable differences in food shapes, starting temperatures and personal preferences. Secondly, these allow for the differences in electrical voltage input which changes during peak load periods. Always remember that it is easier to add time to undercooked food. Once the food is overcooked, nothing can be done. For each recipe, an approximate cooking time is given.

Stirring

Stirring is often necessary during microwave cooking. We have noted when stirring is helpful in the recipes. Always bring the outside edges towards the centre and the centre portions to the outside.

Rearranging or Turning

Some foods should be turned in the container during cooking. For example, because of the different thicknesses in the breast and back sections of poultry, it is a good idea to turn poultry over once to ensure more even cooking.

Rearranging or turning over uneven shaped food in the dish should be done as suggested to ensure a satisfactory result. Rearrange small items such as chicken pieces, prawns, hamburger patties, nuts or potatoes. Rearrange pieces from the centre to the edge of the dish.

Cooking in Layers

This microwave oven is not designed to cook more than 1 layer of food. Cooking in 2 layers may not always be successful, it takes longer and may be uneven. You can successfully reheat two dinner plates of food at one time but remember to increase the reheating time and use a microwave warming rack.

Piercing of Foods

Pierce the skin or membrane of foods such as eggs, tomatoes and jacket potatoes when cooked whole in the microwave oven. This allows steam to escape. If the skin has not been pierced, food may burst.

Cured Meats

Cured meats may overcook in some areas due to the high concentration of salts used in the curing process. So take care when cooking different brands of bacon as cooking times may vary slightly.

Techniques for Preparation

Covering

Covering food minimizes the microwave cooking time. Because microwave cooking is done with time and not direct heat, the rate of evaporation cannot be easily controlled. However, this can be corrected by using different materials to cover dishes. Plastic wrap is the best substitute for a lid as it creates a tighter seal and so it retains more heat and steam. Wax paper and paper towels hold the heat in but not the steam. These materials also prevent splattering. Use a paper towel, wax paper or no cover when steam is not needed for tenderising.

Browning

Meats and poultry, when cooked longer than 10 to 15 minutes, will brown from their own fat. Foods cooked for shorter periods of time can be aided with the help of a browning sauce, worcestershire sauce or soy sauce. Simply brush one of these sauces over meat or poultry before cooking. Baked goods do not need long cooking time and therefore, do not brown. When cakes or cupcakes are iced, no one will notice the visual difference. For cakes or cupcakes, brown sugar can be used in the recipe in place of caster sugar or the surface can be sprinkled with dark spices before baking.

Standing Time

The moisture molecules continue to vibrate in the food when the microwave oven has turned itself off. After all, the molecules were vibrating at 2,450,000,000 times per second during cooking. So cooking continues even after the food is no longer being exposed to the microwaves whether in or outside your microwave oven.

Standing time refers to the time it takes (after the microwave time is completed) to allow the interior of the food to finish cooking.

The amount of standing time varies with the size and density of the food. In meat cookery, the internal temperature will rise between 5 °C and 10 °C if allowed to stand covered for ten to fifteen minutes. Rice and vegetables need shorter standing time, but this time is necessary to allow foods to complete cooking in the centre without overcooking on the edges.

The power level used in microwave cooking also determines the standing time. For example, when using a lower power level the standing time is shorter because of a lower concentration of heat in the food. Foods should always be kept covered while standing in order to retain the heat. If a longer standing time is required (while you cook another food to serve with the first, for instance), cover with aluminum foil.

Converting Your Favourite Conventional Recipes for Microwave Cooking

When adapting conventional recipes for microwave cooking, time are reduced considerably.

For example, a chicken which takes 1 hour to cook in a moderate oven will take 15 to 20 minutes on P7 Power in your microwave oven.

Use similar microwave recipes to help you adapt conventional recipes. Remember, it is always best to undercook a recipe and then add an extra minute or two to finish it off.

Here are some other tips that may help:

- Reduce liquids in a conventional recipe by one half to two thirds, e.g. 1 cup (250 ml) should be reduced to ½ cup (125 ml).
- Add more thickening such as flour or cornflour to sauces and gravies if you do not reduce the liquid.
- Reduce seasonings slightly in a recipe where ingredients do not have time to simmer by microwave.
- Do not salt meats, poultry or vegetables before cooking; otherwise, they will toughen and dry out.
- If one ingredient takes longer to cook than the others, pre-cook it in the microwave oven first. Onion, celery and potato are examples.
- When cooking meat or vegetables, omit any oil or fat that would have been used in a conventional recipe for browning.
- Reduce leavening agents for cakes by one quarter and increase liquids by one quarter.
- Biscuits require a stiff dough. Increase flour by about 20 percent. Substitute brown sugar for white sugar and use biscuit recipes that have dark spices or require icing. Because of the short cooking time, biscuits don't have time to brown. Chill dough for half an hour before baking. This produces a crisper biscuit. Bake biscuits on a glass tray lined with greaseproof paper.
- Since microwaves penetrate foods about two centimetres from the top, bottom and sides, mixtures in round shapes and rings cook more evenly. Corners receive more energy and may overcook.
- Items with a lot of water, such as rice and pasta, cook in about the same time as they would on a conventional stove. (Refer to **Rice** and **Pasta** chapter.)

Select recipes that convert easily to microwave cooking such as casseroles, stews, baked chicken, fish and vegetable dishes. The results from foods such as grilled meats, cooked souffles or two-crust pies could be less than satisfactory. Never attempt to deep fry in your microwave oven.

Menu Planning for Microwave Cooking

How to Keep Everything Hot at The Same Time

Plan your meals so that the food will not all need last minute cooking or attention at the same time. The special features of microwave cookery make it easy to serve meals with everything piping hot. Cooking of some foods may be interrupted while you start others, without harming the nutritional value or flavour of either.

A recipe which requires standing time can be microwaved first and another food cooked while it stands. Dishes prepared in advance can be reheated briefly before serving.

It does take some experience and time to cook with confidence. Microwaves are fast so you will have to do some experimenting. You might find you will use your conventional range in conjunction with your microwave oven. For example, while cooking the roast in the microwave oven, you can be cooking the vegetables and gravy on the range top. This can also be done the other way around. Prepare your meals as follows.

1. Firstly, cook the most dense item (roast or casserole). Drain and retain meat juice from joints then cover with foil.
2. Cook the potatoes, rice or pasta.
3. Cover with foil for standing.
4. Cook greens and other vegetables.
5. Cover with foil for standing.
6. Cook the gravy with the retained meat juices, stock and thickening.
7. Carve the roast and serve the vegetables and gravy.

While you are learning to plan meals, you may get a bit behind time. Don't worry. Dinner servings may be suitably reheated on P7, for 1 to 2 minutes per serving.

If you prefer not to use foil, cover food with saucepan lids. A metal lid will retain the heat for at least 15 minutes.

Meanwhile, how can you cook all the vegetables at the same time? Simply place potatoes and pumpkin in one dish and less dense vegetables such as broccoli, cabbage, cauliflower, beans and peas in another. Sprinkle greens with water. Cover with a lid or plastic wrap. Cook on P10 for cooking times refer to vegetable cooking chart on page 52-53. Fresh and frozen vegetables can be mixed on a vegetable platter, but remember frozen vegetables are not as dense as fresh vegetables, as they have been blanched before freezing.

If vegetables are cut to a similar size, they can be cooked in separate ramekins or small dishes at the same time.

Increasing & Decreasing Recipes

Increasing

- To increase a recipe from 4 to 6 servings, increase each ingredient listed by half.
- To increase a recipe from 4 to 8 servings, double each ingredient listed.
- For larger quantities of a recipe, a large dish should be used. Make sure that the dish is deep enough to prevent the recipe from boiling over during cooking.
- Make sure to cover, stir or rearrange food as directed in the recipe and always check the food during cooking.
- Increase standing times by 5 minutes per 500 g.
- Use the same Power Level recommended in the original recipe.
- Increase the cooking times by: $\frac{1}{3}$ of original cooking time for 6 servings; and an extra $\frac{1}{2}$ of original cooking time for 8 servings.

Decreasing

- To decrease a recipe from 4 to 2 servings, decrease each ingredient listed by half.
- For small quantities, a small dish should be used. Make sure that the dish is large enough to prevent the recipe from boiling over during cooking.
- Use the same Power Level recommended in the original recipe.
- Decrease the cooking times by $\frac{1}{2}$ to $\frac{2}{3}$ of the original cooking time.

Cooking for One

- To decrease a recipe from 4 to 1 serving, quarter each ingredient listed.
- A smaller dish should be used, making sure that the dish is still large enough to prevent the recipe from boiling over.
- Use the same Power Level recommended in the original recipe.
- Quarter the original cooking times, then add extra time, if needed.
- Make sure to cover, stir or rearrange food as directed in original recipe and always check the food during cooking.

Converting Recipes from Other Sources

When the recipe is written with a wattage different than your oven, adjust the cooking time by approximately 10% per 100 watts, e.g. 6 minutes would be adjusted by 36 seconds. Alternately, adjust the power level by one level. If your wattage is higher than the recipe: (1) Adjust time downward or (2) Adjust power level downward. If your wattage is lower than the recipe: (1) adjust time upward or (2) adjust power level upward (when possible).

Converting Recipes from Other Sources

One of the most common uses for a microwave oven is to reheat food. Your Panasonic microwave allows you to either reheat by placing food into the oven and you choose the micro power level and length of heating time or you may reheat automatically by using the SENSOR REHEAT Pad on your microwave. Following are some directions for reheating pre-cooked foods from either frozen refrigerator temperature or room temperature.

General rules for reheating foods by Micro Power

- Many convenience foods contain heating instructions on the packaging. It is best to follow these instructions, being sure to check the wattage of the oven they used and adjust the cooking time if necessary (decrease cooking time by 10% for every 100 watts more powerful your oven is).
 - If package directions are not available, follow the recommendations in the charts on the following pages.
 - All foods must be pre-cooked; raw foods will not cook through during reheating times and if consumed may cause illness.
 - Do not reheat in foil containers, cans or plastic containers as incorrect heating times will result. Place foods into microwave safe bowls or onto dinner-plates before heating.
 - Most foods can be heated on P10 but consider if the food is delicate in structure like baked custard or you have a large quantity, a lower power level for slightly longer may be gentler.
 - Cover foods with plastic wrap if you require a steamed effect or leave uncovered for a drier surface, e.g. Crumbed foods.
- Note:** when cooking by Sensor Cook all food must be covered.
- Stir or re-arrange foods during heating as this will help food heat evenly. Stir after heating and let stand for 2 to 3 minutes. Check temperatures before adding extra heating time and ensure food is hot. If food is not heated enough, consumption may cause illness.

Caution:

Pastry items which have a filling that is high in fat., sugar or moisture will become hotter in the centre and the pastry may only feel warm. Ensure you allow it to stand for several minutes before eating.

Reheating by Micro Power - Frozen Pre-cooked Foods

FROZEN ITEM (Pre-cooked)	POWER	TIME (in minutes)	SPECIAL INSTRUCTIONS
BREAD & BAKED PRODUCT			
Bread 1 slice	P7	10 - 15 sec	Do not let bread get hot, or it will become rubbery and dry out. Remove whole loaf from original wrapper. Place on paper towel to absorb moisture.
1 loaf	P7	1 - 3	
6 rolls	P6	1 - 2	
Cheesecake (450 g)	P3	5 - 7	Remove from container. Defrost on plate.
Muffins - 4 (400 g)	P7	1½ - 2	Place onto paper towel lined plate.
Scones - 6 (400 g)	P6	1½ - 2	Defrost on paper lined plate. Stand 2 minutes.
PIES			
Fruit Pie (600 g)	P3 then P7	5 - 7 5 - 7	Remove from foil container and place uncovered into a pie dish.
Meat Pie (175 g)	P7	4 - 5	Place onto paper towel lined plate.
Pizza (350 g)	P10	5 - 7	Remove from package and place onto paper towel or follow manufacturer's instructions.
FROZEN MEAL			
Fish in Sauce (200 g)	P5	5 - 7	Pierce corner of bag. Heat on a plate.
Frozen Casserole (500 g)	P10	9 - 11	Pierce pouch. Heat on a plate or bowl.
Lasagne (500 g)	P9	11 - 13	Remove from foil container, place into serving dish.
Plated style dinner (320 g)	P5	8 - 10	Remove foil cover and replace with plastic wrap.
Vegetables & Sauce (in the bag) (500 g)	P7	6 - 8	Pierce corner of bag. Heat on a plate.
MISCELLANEOUS			
Chicken Pieces (500 g)	P7	8 - 10	Place onto paper towel lined plate.
Chicken Nuggets (12)	P7	3 - 4	Place onto paper towel lined plate.
Croissants - 4 (200 g)	P3	1 - 1½	Place onto paper towel lined plate.
Fish Fingers - 8 (200 g)	P3 then P10	2 - 4 2 - 3	Place onto paper towel lined plate.
Sausage Rolls (225 g)	P5	2 - 3	Place onto paper towel lined plate.

IMPORTANT POINTS TO CONSIDER WHEN REHEATING COLD FOODS

STARTING TEMPERATURE —

Foods taken from the refrigerator will take longer to reheat than foods from room temperature.

Quantity —

One serving heats faster than several servings. When heating large quantities, stir food to ensure even heating. It is quicker to heat individual plates of food than large quantities in a casserole dish.

Plated Dinners —

Arrange foods with the most dense items towards the outside of the plate. Cover meats with sauces/ gravies if desired, spread out mashed potatoes or rice so it heats more evenly. When assembling plates of leftover foods, use foods which have a similar starting temperature.

Covering Foods —

Most foods need to be covered with one sheet of absorbent paper towel to hold in the heat and prevent splattering without steaming. When more moisture is desired, cover with plastic wrap.

Heating —

Reheating is usually done on P10, however, if food has a more delicate texture, like a baked custard, a lower power setting should be used. P7 for a little longer will be gentler on the food. An average plate of food would generally take 1 to 3 minutes to heat depending on the density of the food. Place it in for the minimum time and add extra heating time if required.

Ensure food is hot by feeling the bottom of the plate in the centre. If the plate is cool, food may be warm but will lose heat quickly as the plate will absorb the heat and taste cold when served.

If food is not heated enough, consumption may cause illness.

Elevation —

Elevate pastries and breads on a small plastic rack with paper towel under the food to prevent it from becoming soggy.

Caution:

Pastry items which have a filling that is high in fat, sugar or moisture will become hotter in the centre and the pastry may only feel warm. Ensure you allow it to stand for several minutes before eating.

IMPORTANT POINTS TO CONSIDER WHEN REHEATING FOODS FROM THE FREEZER

VOLUME —

The greater the volume and the more dense the item, the longer it takes to reheat, e.g. frozen cake will take less time than frozen casserole.

LARGE VOLUME —

Large, dense, frozen precooked foods are best thawed on defrost until icy in the centre then heated on P7. This prevents overcooking of the edges. Stirring is often needed to distribute heat evenly.

Commercial frozen foods —

These foods should be removed from their foil containers if possible and placed into suitable microwave safe containers. If a foil container is used in the microwave oven it shouldn't be more than 4 cm high and must not touch the interior of the microwave oven. Remove the cover from the tray and replace with paper towel or plastic wrap to prevent splattering.

Foods to be served at room temperature —

For best results, defrost for a short time and allow to stand to complete thawing, e.g. frozen cake.

Vacuum sealed pouches —

Pierce pouches, bags before heating to allow steam to escape. This prevents bursting.

Containers —

Use dishes about the same volume of the food or slightly larger to allow for stirring. Remove or release snap seal lids other wise they will pop during heating and may disfigure.

Pies and pastries —

Pies and pastries that contain raw pastry and filling cannot be cooked in the microwave oven. Precooked products can be thawed and heated. Place them on a sheet of paper towel and elevate on plastic rack for best results. For added crispness place under the grill or in a hot oven for few minutes. Pastry items can become tough and rubbery if overheated, remember to allow 5 minutes standing then test before adding extra heating time.

PUMPKIN SOUP

Serves: 4

Ingredients:

1 kg	diced pumpkin
1	onion, diced
2 cups	chicken stock
1 teaspoon	curry powder
	pepper

Method:

Place pumpkin, onion and curry powder in a 2-litre casserole dish. Cover and cook on P10 for 12 minutes. Add chicken stock and pepper. Cook on P10 for 10 minutes. Cool slightly. Purée pumpkin and liquid in blender or food processor. Pour into individual serving dishes and garnish with chives.

To cook by :

Prepare pumpkin as above. Cover securely with plastic wrap. Refer to Potatoes directions on page 20. Select **Potatoes**, then **Start**.

SHORT AND LONG SOUP

Serves: 4

Ingredients:

200 g	fresh singapore noodles
12 (200 g)	frozen mini dim sims
4	green onions, sliced
1 litre	chicken stock
1 teaspoon	crushed garlic
½ teaspoon	chopped ginger
2 tablespoons	soy sauce
1	chicken breast, cooked and sliced
4	baby bok choy, quartered
1 cup	bean sprouts
2 tablespoons	dried onion (optional)

Method:

Place all ingredients except bok choy and bean sprouts in a 4 litre casserole dish and cook on P10 for 10 minutes. Add bok choy and cook on P10 for 2 minutes. Serve in individual bowls topped with bean sprouts and onion.

HINT:

To cook 1 double chicken breast. Place onto a dinner plate. Cover and cook on P7 for 8 to 10 minutes.

PEA AND HAM SOUP

Serves: 6

Ingredients:

2½ cups	green split peas
850 g	smoked ham hock
1	medium onion, chopped
1 tablespoon	fresh thyme leaves
1	bay leaf
6 cups	chicken stock
½ cup	frozen peas

Method:

Wash split peas and place in a 2-litre capacity bowl with 1-litre of water. Cover and allow soaking for 8 hours or overnight. Remove rind from ham hock and discard. Cut meat away from the bone and roughly chop. Reserve bone. Drain peas and place into a 5-litre capacity microwave safe dish. Add ham bone, chopped ham, onion, thyme, bay leaf and chicken stock. Cook uncovered on P10 for 15 minutes. Reduce power to P6 and cook for 15 minutes. Skim top of soup and cook on P6 for a further 30 minutes. Remove ham bone and bay leaf and stir in frozen peas. Cook on P6 for 10 minutes. Blend half the soup and return to the bowl, stirring through the remaining soup. Serve hot with crusty bread.

Tip:

Substitute 500 g bacon bones and 250 g of diced bacon rashers for the ham hock. Do not add salt when cooking lentils or pulses, as they will toughen. Add salt after cooking if desired.

POTATO AND LEEK SOUP

Serves: 4 to 6

Ingredients:

1 kg	potatoes, peeled and diced
2	medium thinly sliced leeks
2 teaspoons	fresh thyme
	pepper
3 cups	chicken stock
150 ml	cream

Method:

Place potatoes, leeks, thyme and pepper in 4-litre casserole dish. Cover and cook on P10 for 8 minutes. Stir in chicken stock. Cover and cook on P10 for 14 to 16 minutes. Purée soup mixture. Stir in cream and serve hot or cold in individual bowls.

To cook by Sensor Cook:

Prepare as above. Cover securely with plastic wrap. Refer to Potatoes directions on page 20. Select **Potatoes**, then **Start**.

CHICKEN AND PRAWN LAKSA

Serves: 4

Ingredients:

Soup:

2 tablespoons	laksa paste
400 ml	coconut milk
1 litre	chicken stock
1 tablespoon	soy sauce
	fresh ground black pepper

Laksa:

250 g	rice noodles
8 cups	boiling water
1 bunch	coriander, leaves chopped
4	small red chillies, seeds removed and finely chopped
½ cup	bean sprouts
4	limewedges
1 tablespoon	peanut oil
400 g	cooked chicken tenderloins, sliced
12	green king prawns, peeled

Method:

Soup:

Place the laksa paste, coconut milk, stock, soy sauce and pepper into a 3-litre dish and cook covered on P10 for 8 to 10 minutes.

Laksa:

Place the noodles and water in a 4 litre dish. Cover and cook on P10 for 2 to 3 minutes, stirring halfway through. Drain well and divide between 4 deep bowls. Place the coriander, chillies, bean sprouts and lime on top. Place the peanut oil and prawns in a 1-litre dish and cook on P7 for 3 to 5 minutes, stirring halfway through. Add the chicken and prawns to each individual bowl and set aside.

To serve:

Heat soup on P10 for 2 minutes. Pour the hot soup over the ingredients in the 4 bowls and serve.

ZUCCHINI SLICE

Serves: 4 to 6

Ingredients:

4 rashers	bacon, diced
1	onion, diced
2 cups	grated zucchini
2 cups	grated carrot
1 cup	grated tasty cheese
1 cup	self raising flour
5	eggs, lightly beaten
125 ml	vegetable oil
1 tablespoon	fresh chopped parsley
	salt and pepper

Method:

Lightly grease a 25 cm square microwave safe dish. Place bacon and onion in a 2-litre casserole dish and cook on P10 for 2 to 3 minutes. Allow to cool slightly. Stir in zucchini, carrot and cheese and flour. In a 1-litre bowl whisk together eggs, oil and parsley. Add to bacon mixture season with salt and pepper and stir until combined. Pour into prepared dish. Cook on P6 for 22 to 24 minutes.

NACHOS SUPREME

Serves: 4 to 6

Ingredients:

500 g	topside mince
35 g	packet taco seasoning mix
⅓ cup	tomato paste
1 teaspoon	Mexican chilli powder
310 g	red kidney beans, mashed in liquid
180 g	packet corn chips
1	avocado
½ cup	sour cream
½ cup	grated cheese
	paprika

Method:

Place meat in a 2-litre dish. Cook on P7 for 6 minutes, stirring halfway through. Mix with fork, breaking up any large pieces of meat. Add taco mix, tomato paste, chilli powder and kidney beans. Cook on P7 for further 10 minutes, stirring halfway through cooking. Place corn chips in a 3-litre microwave suitable serving dish. Pile meat sauce in the centre. In a small bowl, mash avocado and mix in sour cream. Spoon this mixture over meat sauce and top with grated cheese. Sprinkle with paprika. Heat on P7 for 3 to 4 minutes.

NUTS AND BOLTS

Serves: 6 to 8

Ingredients:

80 g	butter
2 teaspoons	curry powder
2 tablespoons	worcestershire sauce
½ teaspoon	salt
¼ teaspoon	garlic powder
100 g	packet mixed rice crackers
100 g	fried noodles
200 g	salted peanuts
125 g	packet pretzel sticks
½ cup	Nutri-Grain

Method:

Place butter, curry, worcestershire sauce, salt and garlic powder in a 3-litre casserole dish. Cook on P10 for 1 to 2 minutes. Add remaining ingredients, mix well and cook on P10 for 4 to 5 minutes. Stir twice through cooking. Allow to cool. Place in a bowl and serve with drinks. Store in an airtight container once cool.

Cooking Fish and Shellfish by Micro Power

Clean fish before starting the recipe. Arrange fish in a single layer, overlap thin fillet ends to prevent overcooking. Prawns and scallops should be placed in a single layer.

Cover dish with plastic wrap. Cook on the power level and for the minimum time recommended in the chart below. Halfway through cooking rearrange or stir prawns, fish fillets or scallops

Cooking Fish and Shellfish by Micro Power

FISH OR SHELLFISH	AMOUNT	POWER	APPROX. COOKING TIME (in minutes)
Fish Fillets	500 g	P4	8 to 10
Scallops (sea)	500 g	P4	6 to 8
Green Prawns medium size (shelled and cleaned)	500 g	P4	7 to 9
Whole Fish (stuffed or unstuffed)	500 g to 600 g	P4	7 to 10

GARLIC & CHILLI PRAWNS

Serves: 4

Ingredients:

1 kg medium uncooked king prawns
1 small red onion, thinly sliced
40 g butter
3 garlic cloves, crushed
2 fresh bird's eye chillies,
deseeded & finely chopped
½ small red capsicum, finely sliced
100 g snow peas, trimmed
1 tablespoon lemon juice
80 ml thickened cream
¼ cup coriander leaves, chopped
Cooked jasmine rice, to serve

Method:

Peel and de-vein prawns leaving tails in tact, set aside. Place onion, butter, garlic and chilli into a 3 Litre microwave safe dish. Cook on P10 for 4 minutes, stir halfway through cooking. Add prawns and mix to combine. Cook on P7 for 3 minutes. Stir in capsicum and snow peas, cover and cook on P7 for a further 3 minutes. Stir through lemon juice, cream and coriander, season and cook on P10 for 1 minute. Serve immediately with cooked rice.

GARLIC PRAWNS

Serves: 2

Ingredients:

60 g butter
2 clove garlic, crushed
1 tablespoon lemon juice
1 tablespoon chopped parsley
500 g peeled green prawns

Method:

Place butter and garlic in a 1-litre dish and cook on P10 for 30 to 50 seconds. Add lemon juice, parsley and prawns. Cook on P6 for 5 to 7 minutes, stirring halfway through cooking. Serve in individual ramekins.

STEAKS WITH LIME BUTTER

Serves: 4

Ingredients:

30 g butter
1 clove garlic, crushed
1 teaspoon grated fresh ginger
1 teaspoon grated lime rind
2 tablespoons lime juice
½ teaspoon sugar
500 g salmon, steaks

Method:

Place butter, garlic, ginger, lime rind, juice and sugar in a shallow dish. Cook on P7 for 1 to 2 minutes. Stir halfway through cooking. Add salmon steaks and coat with sauce. Cover and cook on P5 for 5 to 7 minutes. Stand for 2 to 3 minutes before serving.

To cook by Sensor Cook:

Prepare as above. Cover securely with plastic wrap. Refer to Steam Fish directions on page 21. Select **Steam Fish**, then **Start**.

LEMON PEPPER FISH

Serves: 2

Ingredients:

350 g fish fillets
¼ cup lemon juice
1 teaspoon cracked black pepper

Method:

Place fish, lemon juice and cracked black pepper in 1-litre casserole dish. Cook on P4 for 4 to 6 minutes. Let stand for 3 minutes before serving.

To cook by Sensor Cook:

Prepare as above. Cover securely with plastic wrap. Refer to Steam Fish directions on page 21. Select **Steam Fish**, then **Start**.

BOUILLABAISSSE

Serves: 4 to 6

Ingredients:

2 tablespoons	olive oil
2	onions, sliced
1	large leek, sliced
4 cloves	garlic, crushed
425 g	tomato pieces
½ cup	tomato paste
4 cups	hot fish stock
⅓ cup	dry white wine
1 tablespoon	fresh thyme leaves
½ teaspoon	saffron powder
1 teaspoon	chilli powder
	freshly ground black pepper
	salt
500 g	firm fish fillets, chopped
500 g	green prawns meat de-veined

Method:

Place oil, onions, leek and garlic in a 4-litre dish. Cover and cook on P10 for 6 to 8 minutes. Stir halfway through cooking. Add tomatoes, tomato paste, fish stock, wine, thyme, saffron, and chilli powder. Season with salt and pepper. Cook on P10 for 12 minutes. Add fish fillets and prawns. Cook on P10 for 8 to 10 minutes or until seafood is cooked. Serve garnished with fresh thyme.

TOMATO BASIL MUSSELS

Serves: 4

Ingredients:

1 kg	fresh mussels
¼ cup	water
1 tablespoon	olive oil
1	leek, sliced
1 clove	garlic, crushed
1 (425 g)	can tomato pieces
1 tablespoon	tomato paste
½ teaspoon	oregano
2 tablespoons	chopped fresh basil
	freshly ground black pepper

Method:

Place mussels and water into a bowl. Cover and cook on P7 for 4 to 6 minutes. Set aside. Place oil, leeks and garlic into a 3-litre dish. Cook on P10 for 2 minutes. Stir well, add tomatoes, tomato paste, oregano, basil and pepper. Mix well. Cook on P10 for 3 to 4 minutes. Add mussels. Cover and cook on P10 for 2 to 3 minutes. Serve immediately.

OYSTERS KILPATRICK

Makes: 12

Ingredients:

2 rashers	bacon finely chopped
1 tablespoon	worcestershire sauce
2 teaspoons	lemon juice
1 tablespoon	barbecue sauce
12	oysters in shell

Method:

Spread bacon onto a dinner plate. Cover with paper towel and cook on P10 for 2 to 3 minutes. Mix together worcestershire sauce, lemon juice and barbecue sauce. Place oysters in shell evenly around dinner plate and sprinkle with bacon mixture. Pour some sauce mixture over each oyster. Cook on P10 for 1 to 1½ minutes. Serve with drinks or as an entree.

SEAFOOD MARINARA

Serves: 4

Ingredients:

750 g	Marinara mix
2 tablespoons	butter
1	clove garlic, crushed
2	tomatoes, peeled and chopped
1 tablespoon	tomato paste
¼ cup	white wine
¼ cup	fresh basil leaves, chopped
	pepper

Method:

Place marinara mix into a 2-litre casserole dish. Set aside. Place butter and garlic in 1-litre casserole dish. Cook on P7 for 1 minute. Add remaining ingredients (except seafood), to dish and cook on P10 for 5 minutes. Purée tomato mixture in blender or food processor and pour over seafood. Cook on P6 for 7 to 9 minutes, stir halfway through cooking. Stand for 5 minutes. Serve with salad and pasta.

Cooking Whole Poultry by Micro Power

Season as desired, but salt after cooking. Browning sauce mixed with equal parts of butter will enhance the appearance.

Poultry must be unstuffed. Tie legs together with cotton string. Place on a microwave rack set in a rectangular dish. Place poultry breast-side down: turn over halfway through cooking. Cover with wax paper to prevent splattering.

If the poultry is not cooked enough, return it to the oven and cook a few more minutes at the recommended power level.

DO NOT USE A CONVENTIONAL MEAT THERMOMETER IN THE MICROWAVE OVEN.

Let stand, covered with foil, 10 to 15 minutes after cooking. Standing time allows the temperature to equalize throughout the food and finishes the cooking process.

If a large amount of juice accumulates in the bottom of the baking dish, occasionally drain it. If desired, reserve juices for making gravy.

Less-tender birds should be cooked in liquid such as soup or broth. Use ¼ cup per 500 g of poultry.

Use an oven cooking bag or a covered casserole. Select a covered casserole deep enough so that bird does not touch the lid.

If an oven cooking bag is used, prepare according to package directions. Do not use wire twist-ties to close bag. Use only nylon tie, a piece of cotton string, or a strip cut from the open end of the bag. Make six 2 cm slits on top of bag.

Multiply the weight of the poultry by the minimum recommended minutes per 500 g. See chart below. Programme Micro Power and Time.

After cooking, check the internal temperature of the bird with a microwave or conventional meat thermometer inserted into the muscle. Check temperature in both muscles. The thermometer should not touch bone. If it does, the reading could be inaccurate. A thermometer cannot be accurately inserted into a small bird. To check desired cooking of a small bird, juices should be clear and the drumsticks should readily move up and down after standing time.

During cooking, it may be necessary to shield legs, wings and the breast bone with foil to prevent overcooking. Wooden toothpicks can be used to hold foil in place.



Cooking Poultry Pieces by Micro Power

Cover with wax paper or paper towel. Use the chart below to determine recommended minimum cooking times.

Arrange pieces skin-side down and evenly spread in a shallow dish.

Turn or rearrange halfway through cooking. Shield wing tips, drumstick ends etc., if required.

Cooking Poultry by Micro Power

POULTRY	POWER	TEMPERATURE AFTER COOKING	APPROX. COOKING TIME (minutes per 500 g)
Chickens	P7	87 °C	10 to 15
Chicken (pieces)	P7	87 °C	8 to 10
Turkey	P7	87 °C	12 to 17
Duck	P7	87 °C	10 to 15

COOKING EGGS BY MICRO POWER

Boiled Eggs: Do not boil eggs in your microwave. Raw eggs boiled in their shells can explode and cause serious injury.

Poached Eggs: The membrane on egg yolks must be pierced before cooking, otherwise steam will build up and cause yolk to pop.

Scrambled Eggs: Slightly undercook scrambled eggs as they will finish cooking during standing.

SCRAMBLED EGGS

Serves: 2

Ingredients:

2 x 60 g	eggs
2 tablespoons	milk
	pinch of salt

Method:

In a 1-litre casserole dish, beat eggs lightly with whisk. Add milk and salt. Whisk until well combined. Cover dish with plastic wrap and cook on P6 for 1 to 1½ minutes. Stir eggs and cook for further 1 to 1½ minutes. Stand, covered, for 1 minute before serving.

POACHED EGGS

Serves: 2

Ingredients:

2 x 60 g	eggs
½ cup	hot tap water
	dash of vinegar
	pinch of salt

Method:

Place one quarter of cup of water, dash of vinegar and pinch of salt into 2 ramekin dishes or small glass bowls. Heat water on P10 for 30 - 60 seconds. Break egg into the water and with toothpick pierce the egg yolk twice and egg white several times. Cover dishes with plastic wrap and cook on P6 for 1 to 1½ minutes.

Stand, covered, for 1 minute before serving.

Note: The size of the eggs will alter cooking time.

BACON AND EGG IN A CUP

Serves: 1

Ingredients:

2	slices bacon
1 x 60 g	egg
1 tablespoon	grated cheddar cheese

Method:

Place bacon on a dinner plate between 2 sheets of paper towel cook on P10 for 1 to 2 minutes. Wrap bacon around the inside of a 1-cup ramekin dish. Crack egg into centre of dish and pierce with tooth pick. Cover and cook on P5 for 50 to 70 seconds. Sprinkle with grated cheese.

GREEN PEPPERCORN CHICKEN

Serves: 4

Ingredients:

500 g	sliced chicken breast fillets
2 tablespoons	green peppercorns
1 tablespoon	seeded mustard
1 teaspoon	chicken stock powder
2 tablespoons	lemon juice
½ cup	cream

Method:

Place chicken in a 3-litre casserole dish. Cook on P7 for 8 to 10 minutes stirring halfway through cooking. Mix together peppercorns, mustard, stock powder, lemon juice and cream. Pour over chicken, stir. Cook on P10 for 2 to 3 minutes.

CHICKEN CURRY

Serves: 4

Ingredients:

1	onion, chopped
2 tablespoons	red curry paste
500 g	chicken fillets, sliced
1 tablespoon	fish sauce
1 tablespoon	brown sugar
2 cups	finely sliced vegetables
1 cup	coconut milk

Method:

Place onion and curry paste in a 3-litre casserole dish. Cook on P10 for 2 to 3 minutes. Add chicken and combine. Cook on P7 for 6 minutes, stirring once during cooking. Add fish sauce, brown sugar, vegetables and coconut milk. Stir well. Cover and cook on P10 for 4 to 6 minutes. Serve with Jasmine rice.

CHICKEN CACCIATORE

Serves: 4

Ingredients:

400 g	can diced tomatoes
¼ cup	tomato paste
1 teaspoon	minced garlic
1	onion, diced
2 teaspoons	dried oregano
1 kg	chicken drumsticks
¼	red capsicum, sliced

Method:

Place all ingredients in a 2-litre casserole dish. Stir until combined. Cover and cook on P7 for 10 to 12 minutes. Turn chicken and stir. Cook on P7 for 10 to 12 minutes.

ROAST CHICKEN

Serves: 4 to 6

Ingredients:

1.5 kg	chicken
2 tablespoons	melted butter
	seasonings of your choice
	lemon, pepper, seasoned salt, etc.

Method:

Clean and pat dry chicken with paper towel. Brush chicken with melted butter and sprinkle with seasoning. Place chicken, breast-side down, on rack in 3-litre dish. Cook on P7 for 30 to 35 minutes. Turn halfway through cooking.

HINT:

After cooking whole poultry, cover with foil to retain heat while finishing the remainder of the meal.

CHICKEN BURRITOS

Serves: 4

Ingredients:

1	clove garlic, crushed
2	large onions, chopped
1 teaspoon	chilli powder (optional)
35 g	taco seasoning mix
500 g	chicken tenderloins, diced
425 g	can red kidney beans, drained
½ cup	tomato paste
½ cup	water
1 cup	grated cheese
12	tortillas

Method:

Place garlic, onion and chilli in a 3 litre casserole dish. Cook on P10 for 2 minutes. Stir in remaining ingredients except cheese and tortillas. Cover and cook on P7 for 16 to 18 minutes, stirring twice during cooking. Serve in warmed tortillas topped with grated cheese.

THAI CHICKEN WINGS

Serves: 3 to 4

Ingredients:

1 kg	chicken wings
2 tablespoons	soy sauce
2 tablespoons	fish sauce
2 tablespoons	lime juice
1 teaspoon	crushed garlic
1 teaspoon	crushed ginger
1 teaspoon	crushed chilli

Method:

Place wings into a shallow dish. Combine remaining ingredients and pour over wings. Marinate for at least 2 hours in the refrigerator. Cook on P7 for 15 to 20 minutes, rearranging halfway through cooking.

To cook by Sensor Cook:

Prepare as above. Cover securely with plastic wrap. Refer to Steam Chicken Pieces directions on page 21. Select **Steam Chicken Pieces**, then **Start**.

APRICOT NECTAR CHICKEN

Serves: 4

Ingredients:

400 ml	apricot nectar
40 g	French onion soup mix
1	onion, diced
1	clove garlic, crushed
½ cup	dried apricots
1 kg	chicken legs

Method:

Place all ingredients except chicken legs into a 3-litre dish. Mix well to combine. Add chicken legs and stir to coat with sauce. Cook on P7 for 20 to 25 minutes, stirring halfway through cooking.

CHICKEN SAN CHOY BAU

Serves: 4 to 6

Ingredients:

10	dried shiitake mushrooms
2 teaspoons	sesame oil
1	clove garlic, chopped
500 g	minced chicken
10	water chestnuts, finely chopped
227 g	can bamboo shoots, chopped
¼ cup	soy sauce
1 tablespoon	oyster sauce
2 tablespoons	dry sherry
1	small iceberg lettuce

Method:

Cover mushrooms with boiling water, stand for 30 minutes. Drain, remove stems and chop finely. Place oil and garlic in a 2 litre casserole dish, cook on P10 for 40 to 50 seconds. Add chicken and cook on P7 for 5 to 6 minutes. Add remaining ingredients except lettuce and cook on P7 for 5 to 6 minutes. Separate lettuce leaves. place tablespoons of mixture into each lettuce leaf. Serve immediately.

CHICKEN ROLLS WITH HONEY MUSTARD

Serves: 4 to 6

Ingredients:

8	chicken thigh fillets
16	prunes, pitted
8	green onions, sliced
2 tablespoons	flaked almonds
4 rashers	rindless bacon, halved lengthwise

Honey Mustard Glaze

1 tablespoon	brown sugar
1 tablespoon	French Mustard
1 tablespoon	honey
10 g	butter, melted
	ground black pepper

Method:

Open out each thigh fillet and trim away fat. Place 2 prunes, some spring onion and a few flaked almonds on each fillet. Roll fillets up and wrap a piece of bacon around each one. Secure with toothpicks. Blend all glaze ingredients together in a small bowl. Place chicken into a 3-litre dish in a single layer and brush with glaze mixture. Cook on P7 for 16 to 20 minutes, turning halfway through cooking.

CHICKEN AND ASPARAGUS RISOTTO

Serves: 4

Ingredients:

300 g	fresh asparagus, chopped
2 tablespoons	olive oil
1½ cups	arborio rice
1	clove garlic, crushed
4 cups	boiling chicken stock
2 cups	coarsely chopped cooked chicken
¼ cup	grated fresh parmesan cheese
¼ cup	cream
	ground black pepper
1 tablespoon	chopped parsley
extra	coarsely grated parmesan cheese

Method:

Place asparagus into 2-litre dish and cook on P10 for 1 minute. Set aside. Place oil, rice and garlic in a large microwave safe bowl. Cook covered on P10 for 1 minute. Add 2 cups of boiling chicken stock, cook on P10 for 5 minutes. Stir twice during cooking. Add remaining chicken stock and cook on P10 for another 5 minutes. Add remaining ingredients along with asparagus and stir into risotto. Cook covered on P10 for 2 minutes. Stand for 5 minutes. Serve topped with extra parmesan and black pepper.

HONEY SESAME DRUMSTICKS

Serves: 4

Ingredients:

1 kg	chicken drumsticks
1	clove garlic, chopped
1 teaspoon	chopped ginger
¼ cup	soy sauce
¼ cup	honey
2 tablespoons	sesame seeds

Method:

Place all ingredients in 2-litre bowl, stir until combined. Marinate for at least 2 hours or overnight. Remove chicken from marinade and place in shallow dish with the meatiest ends to the outside. Cook on P7 for 15 to 18 minutes, turning once during cooking.

To cook by Sensor Cook:

Prepare as above. Cover securely with plastic wrap. Refer to Steam Chicken Pieces directions on page 21. Select **Steam Chicken Pieces**, then **Start**.

CHICKEN WINGS IN LEMON SAUCE

Serves: 4 to 6

Ingredients:

1 kg	chicken wings
¼ cup	soy sauce
1 teaspoon	ginger powder
2	cloves garlic, crushed
¼ cup	lemon juice

Method:

Place chicken wings in 3-litre casserole dish. Mix together remaining ingredients and pour over chicken wings. Marinate for 1 to 2 hours in the refrigerator. Cook, covered, on P7 for 15 to 20 minutes. Serve hot with rice.

To cook by Sensor Cook:

Prepare as above. Cover securely with plastic wrap. Refer to Steam Chicken Pieces directions on page 21. Select **Steam Chicken Pieces**, then **Start**.

Cooking Tender Cuts of Meat using Micro Power

For best results, select roasts that are uniform in shape.

Place meat on a microwave rack in a suitable dish. Beef rib roast should be placed cut-side down. Other bone-in roasts should be placed fat-side down. Boneless roasts should be placed fat-side up. Halfway through cooking, turn roasts. Half hams should be shielded by wrapping an 8 cm wide strip of foil around the large end of the ham. Secure to the body of the ham with wooden toothpicks. Fold 3 cm over cut surface. For shank ham halves, shield shank bone by cupping it with foil. One third of the way through cooking, remove ham from oven and cut off skin. Turn fat side up and reshield edges. If desired, glaze last 10 to 20 minutes of cooking. Loosely cover baking dish with wax paper or paper towel to prevent splatter. If a large amount of juice accumulates in the bottom of the dish, drain occasionally. If desired, reserve for making gravy. Multiply the weight of the roast by the minimum recommended times per 500 g. Programme Micro Power and Time.

Meats can be shielded at the beginning of cooking or halfway through cooking. If you wish to shield at the beginning of cooking, remove foil halfway through the cooking time. Beef and pork rib roasts should be shielded around the bones. Foil should extend about 5 cm down from bones. The shank and thin ends of boneless roasts should also be shielded. Make sure foil does not touch the sides of the oven, as arcing may occur. Canned hams should be shielded on the top cut-edge with a 3 cm strip of foil. Wrap strip of foil around ham and secure to body of ham with wooden toothpicks. Fold 2 cm over cut surface. After heating, check temperature using a meat thermometer. The thermometer should not touch bone or fat. If it does, the reading could be inaccurate. Lower temperatures are found in the centre of the roast and in the muscle close to a large bone, such as a pork loin centre rib roast. If the temperatures are low, return meat to the oven and cook a few more minutes at the recommended power level. **DO NOT USE A CONVENTIONAL MEAT THERMOMETER IN THE MICROWAVE OVEN.** Let stand, covered with foil, 10 to 15 minutes. During standing time the internal temperature equalises and the temperature rises 5 °C to 10 °C.

Cooking Less-Tender Cuts of Meat by Micro Power

Less-tender cuts of meat such as pot roasts should be cooked in liquid. Use ½ to 2 cups of soup, broth, etc. per 500 g of meat. Use an oven cooking bag or covered casserole when cooking less-tender cuts of meat. Select a covered casserole deep enough so that the meat does not touch the lid. If an oven cooking bag is used, prepare the bag according to package directions. Do not use wire or metal twist-ties. Use the nylon tie provided, otherwise, use a piece of cotton string or a strip cut from the open end of the bag. Make six 2 cm slits in top of bag to allow steam to escape. Multiply the weight of the roast by the minimum recommended minutes per 500 g as suggested in the chart below. Programme Power and Time. Turn meat over halfway through cooking. Meat should be tender when cooked.

Meat Chart for Microwave Cooking

MEAT	POWER	APPROX. COOKING TIME (minutes per 500 g)
Beef		
Roasts Medium		
Rare	P6	10 to 12
Medium	P6	12 to 14
Well	P6	14 to 16
Pot Roast	P2	25 to 30
Pork		
Leg of Pork	P7	11 to 13
Loin of Pork	P7	11 to 13
Ham Canned (fully cooked)	P7	4 to 5
Lamb		
Medium	P6	8 to 10
Well	P6	12 to 14

THAI BEEF CURRY

Serves: 4 to 6

Ingredients:

1	onion, thinly sliced
2 tablespoons	Thai green curry paste
500 g	thinly sliced lean beef
½	red capsicum, thinly sliced
1	carrot, thinly sliced
1	zucchini, sliced
200 g	broccoli, broken into flowerets
1 cup	coconut milk
1 tablespoon	soy sauce
1 tablespoon	lemon juice
2 tablespoons	shredded fresh basil
½ cup	roasted unsalted peanuts

Method:

Place the onion and curry paste into a 4-litre dish. Cook on P10 for 2 to 3 minutes. Add the beef and cook on P10 for 4 to 6 minutes, stirring halfway through cooking. Add the vegetables and coconut milk and cook on P10 for 6 to 8 minutes. Mix in the soy sauce, lemon juice and basil and serve sprinkled with peanuts.

MUSSAMAN BEEF CURRY

Serves: 4

Ingredients:

500 g	round steak diced
½ cup	mussaman curry paste
400 g	potato diced
250 ml	coconut milk
250 ml	beef stock
1 tablespoon	brown sugar

Method:

Place steak, curry paste and potato in a 3-litre casserole dish cook on P10 for 6 minutes. Add coconut milk, beef stock and brown sugar, stir, cook on P5 for 40 minutes. Stir once during cooking serve with jasmine rice.

To cook by :

Follow general directions. Cover securely with plastic wrap. Refer to Curries directions on page 22. Select **Curries**, then press **Start**.

BEEF BOURGUIGNONNE

Serves: 4 to 6

Ingredients:

750 g	diced chuck steak
4 rashers	bacon
6	pickling, onions
2 cloves	garlic, minced
¼ cup	red wine
400 ml	tomato puree
½ cup	beef stock
1 teaspoon	minced chilli
1 teaspoon	dried tarragon
250 g	button mushrooms, halved

Method:

Place all ingredients except mushroom in a 3-litre casserole dish, stir until combined. Cover and cook on P7 for 14 to 16 minutes. Stir and cook on P4 for 28 to 30 minutes. Stir and add mushrooms halfway through cooking

CORNEBEEF

Serves: 4

Ingredients:

1.5	corned silverside
1 tablespoon	brown sugar
1 tablespoon	white vinegar
1	onion, cut in half
4	cloves
6	peppercorns
1	bay leaf
5 cups	water

Method:

Rinse corned silverside under cold running water to remove excess salt. Place corned silverside in 4-litre casserole dish. Add remaining ingredients. Cover and cook on P10 for 10 minutes. Turn meat, cover and cook on P3 for 1¼ to 1½ hours. Stand corned silverside in cooking liquid for 10 minutes before carving.

Note: Depending on the size and shape of the silverside, it may require a further 10 to 15 minutes on P3.

FRENCH ONION BEEF CASSEROLE

Serves: 4

Ingredients:

100 g	onion, chopped
1 teaspoon	minced garlic
200 g	diced potatoes
600 g	beef, diced
100 g	carrots, diced
1/3 cup	tomato paste
1 1/2 cups	beef stock
100 g	whole button mushrooms
1/4 cup	frozen peas

Method:

Place onion and garlic in 3-litre casserole dish. Cook on P10 for 1 to 2 minutes. Add remaining ingredients, except mushrooms and peas. Stir until combined. Cover and cook on P10 for 8 minutes. Stir and cook on P4 for 28 to 30 minutes. Add mushrooms and frozen peas. Stir cook on P4 for 14 to 15 minutes.

SPAGHETTI MEAT SAUCE

Serves: 4 to 6

Ingredients:

500 g	minced beef
1	onion, chopped
1 clove	garlic, minced
425 g	can tomatoes
1 cup	tomato paste
2	beef stock cubes
1 teaspoon	dried mixed herbs
	pepper

Method:

Combine all ingredients in a 3-litre casserole dish. Cook on P10 for 7 minutes, stir. Cook on P7 for 14 to 16 minutes. Stir halfway through cooking. Serve with spaghetti.

BEEF STROGANOFF

Serves: 4

Ingredients:

1	onion, sliced
1 clove	garlic, minced
750 g	rump steak sliced thinly
2 tablespoons	tomato sauce
2 tablespoons	worcestershire sauce
1	beef stock cube
1 teaspoon	paprika
1/3 cup	sour cream
200 g	sliced mushrooms

Method:

Place all ingredients (except sour cream and mushrooms) in a 3-litre casserole dish. Stir until combined. Cover and cook on P7 for 7 to 9 minutes, stirring once during cooking. Add mushrooms. Stir and cook on P7 for 4 to 5 minutes. Stir through sour cream.

CHINESE BEEF AND VEGETABLES

Serves: 4 to 6

Ingredients:

500 g	rump steak sliced
1 teaspoon	chopped ginger
1 clove	garlic, chopped
1 tablespoon	soy sauce
1/4 cup	Hoisin sauce
1/4 cup	sweet chilli sauce
3 cups	sliced vegetables

Method:

Place steak, ginger and garlic in a 3-litre casserole dish. Cook on P10 for 1 minute. Add soy sauce, Hoisin sauce and chilli sauce to meat mixture. Cook on P10 for 4 to 5 minutes. Add the vegetables, cover and cook on P10 for 3 to 5 minutes, stirring halfway through cooking. Let stand for 5 minutes before serving.

LAMB KORMA

Serves: 4

Ingredients:

1	onion, diced
500 g	lamb, cubed
½ cup	korma curry paste
2	large carrots sliced
250 ml	tomato puree
250 ml	beef stock
2 tablespoons	natural yoghurt

Method:

Place onion, lamb, curry paste and carrot in a 3-litre casserole dish. Cook on P10 for 6 minutes. Add tomato puree and beef stock and stir, cook on P5 for 40 minutes, stirring once during cooking. Stir in yoghurt and serve with basmati rice.

To cook by :

Follow general directions. Cover securely with plastic wrap. Refer to Curries directions on page 22. Select **Curries**, then press **Start**.

SEASONED ROAST LAMB

Serves: 4 to 6

Ingredients:

1.4 kg	leg of lamb
1 tablespoon	seeded mustard
1 tablespoon	rosemary

Method:

Place lamb fat side down on rack set in a 3-litre dish. Brush with mustard and rosemary. Cook on P6 for 30 to 35 minutes, turn halfway through cooking. Stand, covered, for 15 minutes before slicing.

GOULASH

Serves: 4

Ingredients:

1	onion, chopped
1	clove garlic, crushed
1 tablespoon	butter
2 tablespoons	tomato paste
1 teaspoon	paprika
500 g	lamb, diced
1	small capsicum, diced
1 cup	beef stock
2 tablespoons	flour
2 tablespoons	water
2 tablespoons	sour cream

Method:

Place onion, garlic and butter in 3-litre casserole dish. Cook on P10 for 1 to 2 minutes. Add tomato paste and paprika. Cook on P10 for a further 2 minutes. Add lamb, capsicum and stock. Cover and cook on P6 for 25 to 30 minutes, stirring halfway through cooking. Mix flour with 2 tablespoons of water and stir into goulash mixture. Cook on P10 for 1 to 2 minutes. Stir in sour cream and serve with pasta and rice.

LAMB PILAU

Serves: 4

Ingredients:

1	tablespoon	oil
1		large onion, sliced
600 g		lean lamb, diced
400 g		can tomato pieces
2 teaspoons		garam masala
1 teaspoon		dried thyme
1 cup		long grain rice
600ml		hot chicken stock
150g		natural yoghurt
		freshly ground black pepper

Method:

Place the oil and onion in a 3 litre dish. Cover and cook on P10 for 2 to 3 minutes. Add lamb, tomato pieces, garam masala, and thyme. Cover and cook on P7 for 10 minutes. Stir. Cook on P7 for a further 10 minutes. Add the rice and chicken stock and cook covered on P5 for a further 30 minutes or until the rice is tender. Stir in yoghurt, season with pepper and serve.

GINGERED PORK STIR FRY

Serves: 4

Ingredients:

500 g	sliced lean pork
¼ cup	teriyaki sauce
1 tablespoon	honey
2 teaspoons	minced ginger
2 teaspoons	cornflour
1	onion, sliced
300 g	sugar snap peas, trimmed
1	zucchini, sliced
½	red capsicum, sliced
2	green onions, sliced
½ cup	bean sprouts
1 tablespoon	toasted sesame seeds

Method:

Place pork, teriyaki sauce, honey, ginger and cornflour in a 2-litre dish. Cover and marinate in the refrigerator for 2 hours. Place onion in a 3 litre dish. Cook on P10 for 1 to 2 minutes. Add marinated pork and sauces and cook on P7 for 3 to 4 minutes. Add peas, zucchini, capsicum, green onions and bean sprouts. Cook on P10 for 3 to 4 minutes. Sprinkle with sesame seeds and serve with noodles.

HINT:

It is better to cook meat for a lesser time in a recipe and add extra time if needed. This will prevent over cooking.

Cooking Fresh Vegetables By Micro Power

Place vegetables in a casserole dish. Add 2 to 3 tablespoons of water per 500 g of vegetables. Add salt to water or add after cooking. Do not place salt directly on vegetables. Cover dish with glass lid or plastic wrap. Cook on P10 according to time recommended in charts. Halfway through cooking, stir, turn vegetables over or rearrange.

Vegetables that are to be cooked whole and unpeeled, need to be pierced to allow steam to escape. Place vegetables on a paper towel lined dinner plate. Allow to stand, covered, according to the time indicated in the charts.

Cooking Fresh Vegetables by Micro Power

Vegetables should be covered and cooked on P10 power for best results. Weights given are trimmed weights.

VEGETABLE	QUANTITY	COOKING PROCEDURE	APPROX. COOKING TIME (in minutes) on P10
Asparagus	250 g	Covered dish with ¼ cup water	1 to 3
Beans (finely sliced)	250 g	Covered dish with ¼ cup water	3 to 5
Beetroot	4 whole (1 kg)	Covered with 1 cup water in 4-litre dish. Stand after cooking - 5 mins.	14 to 18
Broccoli	250 g	Covered dish with ¼ cup water.	4 to 6
Brussels Sprouts	250 g	Covered dish with ¼ cup water.	4 to 6
Cabbage	500 g	Shredded, with ¼ cup water in covered dish.	5 to 7
Carrots	4 (sliced finely) 250 g	With ¼ cup water in covered dish.	5 to 6
Cauliflower	500 g	With ¼ cup water in covered dish.	6 to 8
Celery	6 stalks (400 g) cut in 1 cm pieces	With ¼ cup water in covered dish.	4 to 6
Corn	2 cobs (500 g) 4 cobs (1 kg)	Brush with melted butter and cook in covered dish.	4 to 6 10 to 12
Eggplant	1 (500 g)	Dice with ¼ cup water in covered dish.	4 to 6
Mushrooms	250 g (sliced)	Cook with 2 tablespoons butter in covered dish.	2 to 4
Onions	3 (200 g)	Cut in quarters with ¼ cup water in covered dish.	5 to 7
Peas	250 g	Shell peas and place with ¼ cup water in covered dish.	3 to 5
Potatoes-Mashed -Jacket	500 g 3 Med	Peeled and quartered with ¼ cup water. Covered. Cook uncovered on paper towel lined plate.	8 to 10 7 to 9
Pumpkin	500 g	Peeled and cut into uniform pieces with ¼ cup water in covered dish.	7 to 9
Spinach/Silver Beef	250 g	Remove stem, cut leaves into small pieces. Cook with ¼ cup water in covered dish.	4 to 6
Sweet Potato	500 g	In serving size pieces with 2 tablespoons water in covered dish.	7 to 9
Turnips	500 g	Peeled and sliced finely with ¼ cup water in covered dish.	6 to 8
Tomatoes	2 (300 g)	Sliced and cooked covered.	2 to 4
Zucchini	500 g	Cut in 2 cm pieces in covered dish.	5 to 7

Cooking Frozen Vegetables By Micro Power

Remove vegetables from package and place in an appropriate sized container. Vegetables frozen in a pouch should be placed on a dish and the top pierced. Cook on P10 according to directions given in chart. Vegetables should be cooked covered with a lid or plastic wrap. Halfway through cooking, stir, turn vegetables over or rearrange. Stir after cooking. Allow to stand for 2 to 3 minutes before serving.

Cooking Frozen Vegetables by Micro Power

VEGETABLE	QUANTITY	COOKING PROCEDURE	APPROX. COOKING TIME (in minutes) on P10
Beans	250 g	Cook in covered 2-litre dish.	4 to 6
Broad Beans	250 g	Cook in covered 2-litre dish.	5 to 7
Broccoli (spears)	350 g	Cook in covered 2-litre dish.	5 to 7
Brussels Sprouts	250 g	Cook in covered 2-litre dish.	5 to 7
Carrots (baby)	250 g	Cook in covered 2-litre dish.	6 to 8
Cauliflower	500 g	Cook in covered 2-litre dish.	5 to 7
Corn (½ cob)	125 g	Cook in covered 2-litre dish.	3 to 4
Corn (cobs)	250 g	Cook in covered 2-litre dish.	5 to 7
Mixed Vegetables	250 g	Cook in covered 2-litre dish.	5 to 7
Peas	250 g	Cook in covered 2-litre dish.	4 to 6
Spinach	250 g	Cook in covered 2-litre dish.	4 to 6

Cooking Dried Beans and Peas by Micro Power

Place hot tap water in 4-litre dish. Bring hot water to the boil on High for 10 to 12 minutes. Add beans and 2 tablespoons oil to water. Cook according to directions in chart. Stir. Allow to stand, covered, for 15 to 20 minutes.

Note: Beans such as red kidney beans and lima beans should be soaked overnight before cooking. 250 g of dried beans equals about 3 cups cooked beans. Use in place of canned beans.

Cooking Dried Beans and Peas by Micro Power

ITEM	CONTAINER	AMOUNT OF HOT WATER	APPROX. TIME TO BOIL HOT WATER on P10 (in minutes) COVERED	TO COOK BEANS on P3 (in minutes) COVERED
Lentils (250 g)	4-litre dish	2 litres	10 to 12	15 to 20
Soup Mix (250 g)	4-litre dish	2 litres	10 to 12	20 to 25
Split Peas or Lentils (250 g)	4-litre dish	2 litres	10 to 12	25 to 30
Beans (250 g) Soaked overnight	4-litre dish	2 litres	10 to 12	25 to 30

POTATO BAKE

Serves: 4 to 6

Ingredients:

750 g	peeled and sliced potatoes
300 ml	cream
¼ cup	milk
3	green onions, sliced
2	bacon rashers, chopped
½ cup	grated cheese

Method:

Combine potatoes, cream and milk in 2-litre casserole dish. Cook on P10 for 15 to 18 minutes. Top with green onions, bacon and cheese. Cook on P10 for 5 minutes.

VEGETABLE FRITTATA

Serves: 4 to 6

Ingredients:

400 g	potatoes, thinly sliced
½	red capsicum, sliced into strips
½	green capsicum, sliced into strips
1	tomato, diced
2 tablespoons	fresh basil, chopped
4	eggs
⅓ cup	sour cream
½ teaspoon	cracked black pepper
½ cup	grated tasty cheese

Method:

Place potatoes in a 2-litre shallow dish. Cook on P10 for 5 to 7 minutes. Arrange capsicum in a circular pattern on top of potato sprinkle with tomato and basil. Beat together eggs and sour cream in a jug. Pour over vegetables. Cook on P6 for 3 to 5 minutes. Sprinkle with pepper and cheese and cook on P6 for 7 to 9 minutes.

ARDENNIS STYLE POTATOES

Serves: 4

Ingredients:

4	medium sized potatoes
100 g	ham, finely diced
3 tablespoons	snipped chives
50 g	butter
½ cup	grated Cheddar cheese
	ground black pepper

Method:

Scrub potatoes, wash and pat dry with paper towel. Prick skins and place on a dinner plate. Cook on P10 for 6 to 8 minutes.

To cook by Sensor Cook:

Prepare as above. Cover securely with plastic wrap. Refer to Potatoes directions on page 20. Select **Potatoes**, then **Start**.

Allow to cool slightly. Cut tops off potatoes and scoop out pulp from centre, leaving 1 to 2 cm in shell. Mash pulp and combine with remaining ingredients. Spoon filling back into potato shells. Place potatoes in 2-litre casserole dish. Cook on P10 for 2 to 3 minutes.

CREAMED SPINACH

Serves: 4

Ingredients:

1	bunch spinach, roughly chopped
4	green onions, finely chopped
1	clove garlic, crushed
2 tablespoons	sour cream
	salt and pepper

Method:

Cook washed spinach leaves, green onions and garlic in a covered 3-litre casserole dish on P10 for 5 to 7 minutes.

To cook by Sensor Cook:

Prepare as above. Cover securely with plastic wrap. Refer to Vegetables directions on page 20. Select **Vegetables**, then **Start**.

Drain well by squeezing between two dinner plates. Stir through sour cream. Season to taste. Cook on P10 for 1 to 2 minutes. Serve.

CAULIFLOWER AU GRATIN

Serves: 4

Ingredients:

500 g	trimmed cauliflower and cut into pieces
2 tablespoons	water
2 tablespoons	butter
2 tablespoons	flour
1 cup	milk
¼ cup	grated tasty cheese

Method:

Place cauliflower and water in a shallow casserole dish. Cover and cook on P10 for 6 to 8 minutes.

To cook by Sensor Cook:

Prepare as above. Cover securely with plastic wrap. Refer to Vegetables directions on page 20. Select **Vegetables**, then **Start**.

Stand, covered, while making sauce. Place butter in a 4-cup glass jug. Cook on P10 for 1 to 2 minutes. Stir in flour and cook on P10 for 1 minute. Add milk gradually. Stir well. Cook on P10 for 2 to 3 minutes, stirring halfway through cooking. Drain cauliflower and pour over sauce. Sprinkle with cheese. Cook on P7 for 1 to 2 minutes.

Note: Depending on size and arrangement of cauliflower pieces, timing will vary.

THAI VEGETABLE CURRY

Serves: 4

Ingredients:

1	onion, sliced
2 tablespoons	green curry paste
3 cups	sliced vegetables
440 g	chick peas, drained
1 cup	coconut milk
1 tablespoon	lemon juice
1 tablespoon	soy sauce
½ cup	chopped nuts

Method:

Place onion and curry paste in a 3-litre casserole dish. Cook on P10 for 2 minutes. Add vegetables, chick peas, coconut milk, lemon juice and soy sauce. Cook on P10 for 6 to 8 minutes. Sprinkle with chopped nuts. Serve with jasmine rice.

HERBED VEGETABLES

Serves: 4 to 6

Ingredients:

200 g	sliced snow peas
200 g	sliced carrots
200 g	sliced zucchini
2 tablespoons	chopped fresh parsley

Method:

Place snow peas, carrots and zucchini in a 2-litre casserole dish. Cover. Cook on P10 for 4 to 6 minutes, stirring once during cooking. Sprinkle with parsley. Serve.

TOMATO VEGETABLE CASSEROLE

Serves: 4 to 6

Ingredients:

200 g	mushrooms, sliced
1	eggplant, chopped
200 g	zucchini, sliced
1	capsicum, sliced
1	onion, sliced
400 g	can tomatoes
½ cup	tomato paste
1 tablespoon	chopped basil
1 clove	garlic, minced

Method:

Place mushrooms, eggplant, zucchini, capsicum and onion in a 3-litre casserole dish. Cover. Cook on P7 for 10 minutes. Add tomatoes, tomato purée, herbs and garlic. Re-cover and cook on P10 for 8 to 10 minutes.

Add remaining ingredients. Cover with plastic wrap. Cook on P10 for 8 to 10 minutes.

HINT:

It is better to slightly undercook vegetables as they will soften on standing. Allow to stand, covered, with plastic wrap or a lid.

HINT:

Wrap jacket potatoes in foil after cooking. They will retain their heat for about 15 to 20 minutes.

HINT:

TO SKIN TOMATOES: Cut a cross into the tomato skin. Place 1 cup of hot tap water in a 2 cup jug or bowl and heat on P10 for 1½ minutes or until boiling. Add 1 tomato and heat for a further 20 to 30 seconds. Remove and repeat procedure with remaining tomatoes. The skin will loosen and can be easily removed.

SAVOURY BRUSSELS SPROUTS

Serves: 4

Ingredients:

250 g	brussels sprouts
1 tablespoon	butter
150 g	bacon, finely chopped
1	onion, finely chopped
1 teaspoon	dill or basil
1 teaspoon	sugar

Method:

Wash and drain brussels sprouts. Cook in a covered 2-litre casserole dish on P10 for 4 to 5 minutes.

To cook by Sensor Cook:

Prepare as above. Cover securely with plastic wrap. Refer to Vegetables directions on page 20. Select **Vegetables**, then **Start**.

Drain and set aside. Place remaining ingredients in separate 1-litre casserole dish. Cook on P10 for 3 to 5 minutes. Add brussels sprouts and cook on P10 for 1 to 2 minutes. Serve.

HONEY GLAZED CARROTS AND SUGAR SNAP PEAS

Serves: 4 to 6

Ingredients:

350 g	carrots
150 g	sugar snap peas, trimmed
2 tablespoons	brown sugar
2 teaspoons	butter
2 tablespoons	honey
1 tablespoon	toasted sesame seeds

Method:

Peel and thinly slice carrots. Combine all ingredients in a 2-litre casserole dish. Cover and cook on P10 for 5 to 7 minutes, stirring halfway through cooking. Serve.

To cook by Sensor Cook:

Prepare as above. Cover securely with plastic wrap. Refer to Vegetables directions on page 20. Select **Vegetables**, then **Start**.

PARMESAN ASPARAGUS

Serves: 2 to 4

Ingredients:

1	bunch of asparagus spears
2 tablespoons	water
1 tablespoon	butter
1	clove garlic, crushed
1 tablespoon	grated Parmesan cheese

Method:

Place asparagus and water in a 2-litre casserole dish. Cover and cook on P10 for 1 to 2 minutes. Drain. Place butter and garlic in a small dish and cook on P10 for 1 minute. Add drained asparagus and mix lightly. Cook on P10 for a further 1 minute. Sprinkle Parmesan cheese over asparagus. Serve.

Tip:

When placing asparagus in dish, place half the tips one way and half the tips in the opposite direction for more even cooking.

RED COCONUT DHAL

Serves: 4 to 6

Ingredients:

1 cup	red lentils
1 teaspoon	turmeric
400 ml	coconut milk
250 ml	water
1 teaspoon	crushed red chilli
1 teaspoon	crushed garlic
	lemon juice to taste

Method:

Place all ingredients in a 2 litre casserole dish. Stir and cook on P6 for 18 to 20 minutes, stirring twice during cooking.

To cook by Sensor Cook:

Prepare as above. Cover securely with plastic wrap. Refer to Legumes directions on page 20. Select **Legumes** then **Start**.

HUMMUS**Ingredients:**

1 cup	chick peas, water for soaking
3 cups	boiling water
2 tablespoons	lemon juice
2 teaspoons	turmeric
¼ cup	tahini (sesame paste)
4 cloves	garlic, minced
2 tablespoons	olive oil

Method:

Place chickpeas and water into a 4-litre casserole dish and soak overnight. Drain.

Place chickpeas and boiling water into a 3-litre casserole dish and cook on P6 for 25 to 30 minutes.

Drain, process with remaining ingredients.

To cook by Sensor Cook:

Prepare as above. Cover securely with plastic wrap. Refer to Legumes directions on page 20. Select

Legumes then **Start**.

CHICKPEA SALAD WITH CORIANDER DRESSING

Serves: 4 to 6

Ingredients:

1 cup	dried chickpeas, water for soaking
3 cups	boiling water
1	red capsicum, diced
1	lebanese cucumber, diced
250 g	cherry tomatoes, quartered
1	spanish onion, diced

Coriander Dressing:

½ cup	lemon juice
2 teaspoons	sugar
½ cup	chopped fresh coriander
1 teaspoon	chopped red chilli

Method:

Cover chickpeas with water and soak overnight.

Drain. Place chickpeas and boiling water into a 3-litre dish and cook on P7 for 25 to 30 minutes.

To cook by Sensor Cook:

Prepare as above. Cover securely with plastic wrap. Refer to Legumes directions on page 20. Select

Legumes then **Start**.

Drain and allow to cool.

Combine remaining salad ingredients in a large bowl and mix well.

Dressing:

Combine all ingredients in a screw top jar, shake well. Pour over salad and toss well.

LENTIL HOT POT

Serves: 4 to 6

Ingredients:

900 g	new potatoes
2	onions, diced
2	carrots, diced
2	stalks celery, sliced
3	cloves garlic, crushed
1 teaspoon	curry powder
400 g	can diced tomatoes
1 cup	vegetable stock
2 tablespoons	tomato paste
¾ cup	red lentils, washed
½ cup	grated cheese
	paprika
1 tablespoon	chopped parsley

Method:

Wash potatoes and place onto a paper towel lined plate. Cook on P7 for 8 to 10 minutes.

To cook by Sensor Cook:

Prepare as above. Cover securely with plastic wrap. Refer to Potatoes directions on page 20. Select

Potatoes then **Start**.

Set aside. Place onion, carrot, celery and garlic into a 3 litre dish. Cook on P7 for 7 to 8 minutes. Add curry powder and cook on P7 for a further 1 minute. Add tomatoes, stock, tomato paste and lentils. Cook on P7 for 20 to 24 minutes, stirring halfway through cooking. Slice potatoes thickly and layer over the top of lentil mixture. Sprinkle with grated cheese, paprika and parsley. Cook on P10 for 4 to 6 minutes.

Cooking Rice by Micro power

Follow directions in chart for recommended dish size, amounts of water and cooking time. Add rice to water. Add salt and butter according to package directions. Cook on P10 for time recommended in chart. Allow to stand, covered, before serving. For special rice, substitute beef or chicken stock for water. Add cooked onion, mushrooms or crumbled bacon before serving.

ITEM	CONTAINER	AMOUNT OF WATER	APPROX. TIME TO COOK GRAIN on P10 UNCOVERED (in minutes)	STANDING TIME (in minutes)
RICE Quick Cook Brown (1 cup)	2-litre dish	1½ cups	10	5
Brown (1 cup)	3-litre dish	3 cups	25 to 30	10
Long Grain (1 cup)	2-litre dish	2 cups	12 to 14	5
Short Grain (1 cup)	2-litre dish	2 cups	12 to 14	5
Jasmine (1 cup)	3-litre dish	2 cups	12 to 14	5

Cooking Pasta by Micro Power

Follow directions in chart for recommended dish size, amount of water and cooking time. Boil water, with 1 teaspoon salt and 1 tablespoon oil. Add pasta and cook for time recommended in chart. Cook on P10. Test pasta for desired cooking before adding more time. Slightly undercook pasta that will be heated again in casserole. Stir and let stand, uncovered, 5 minutes.

ITEM	CONTAINER	AMOUNT OF BOILING WATER	APPROX. TIME TO COOK GRAIN on P10 UNCOVERED (in minutes)	STANDING TIME (in minutes)
Dried Fettuccine (250 g)	4-litre dish	6 cups	10 to 12	5
Elbow Macaroni, shells, etc. (250 g)	3-litre dish	4 cups	12 to 14	5
Fresh Spaghetti, Fettuccine (375 g)	4-litre dish	6 cups	6 to 8	5
Dried Spaghetti (250 g)	4-litre dish	4 cups	12 to 14	5
Fresh Tortellini, Ravioli (250 g)	4-litre dish	4 cups	7 to 9	5
Fresh Gnocchi (375 g)	4-litre dish	6 cups	6 to 8	5

Cooking Dried Noodles by Micro Power

Follow directions in chart recommended dish size, amount of water and cooking time. Add 1 tablespoon of oil to water to prevent noodles from sticking together. Add noodles and cook for time recommended in chart. Cook noodles on P10. Test noodles for desired cooking before adding extra time. Slightly undercook noodles that will be cooked again in a stir-fry or recipe. Always drain noodles immediately after cooking or they may overcook on standing.

ITEM	CONTAINER	AMOUNT OF BOILING WATER	APPROX. TIME TO COOK GRAIN on P10 UNCOVERED (in minutes)	INSTRUCTION
2 minutes noodles (85 g)	1-litre	500 ml	2 to 3	drain immediately
Long Life Asian Noodles (250 g)	3-litre	1 litre	5 to 6	drain immediately
Rice Vermicelli (125 g)	2-litre	1 litre	3 to 4	drain immediately

PAELLA

Serves: 6 to 8

Ingredients:

500 g	mussels
¼ cup	water
1	green capsicum, sliced
1	red capsicum, sliced
1	onion, sliced
1 clove	garlic, crushed
2 tablespoons	butter
2 cups	long grain rice
400 g	can peeled tomatoes, chopped
2 cups	hot chicken stock
	pinch saffron powder
1½ cups	cooked diced chicken
200 g	peeled green prawns

Method:

Place mussels and water in a 3-litre dish. Cover and cook on P7 for 3 to 5 minutes. Set aside. Place capsicum, onion, garlic and butter into 4-litre dish and cook on P10 for 4 to 5 minutes. Add rice and stir well. Cook on P10 for 2 to 4 minutes. Stir in tomatoes, hot chicken stock and saffron. Cook on P10 for 16 to 18 minutes. Stir in chicken, prawns and mussels. Cook on P7 for 4 to 6 minutes. Stand for 10 minutes before serving.

FRAGRANT COCONUT RICE

Serves: 4 to 6

Ingredients:

1	onion, chopped
2 cups	long grain rice
500 ml	chicken stock
400 ml	coconut milk
1 teaspoon	turmeric

Method:

Place all ingredients in a 3-litre casserole dish. Stir. Cook on P10 for 15 to 18 minutes. Cover and let stand 10 minutes before serving.

To cook by Sensor Cook:

Prepare as above. Cover securely with plastic wrap. Refer to Rice directions on page 22. Select **Rice**, then **Start**.

SEASONED RICE

Serves: 4 to 6

Ingredients:

1	onion, chopped
1 cup	long grain rice
1 teaspoon	thyme
1½ cups	chicken stock
¼ cup	toasted slivered almonds

Method:

Place onion, rice, thyme and chicken stock in a 3-litre casserole dish. Cook on P10 for 14 to 16 minutes. Stir, cover, and let stand for 10 minutes. Stir through slivered almonds and serve hot.

To cook by Sensor Cook:

Prepare as above. Cover securely with plastic wrap. Refer to Rice directions on page 22. Select **Rice**, then **Start**. When oven beeps, remove plastic wrap.

FRIED RICE

Serves: 4

Ingredients:

1 tablespoon	sesame oil
1	clove garlic, crushed
1 cm	piece of green ginger, finely chopped
1	small carrot, finely chopped
1	stick celery, sliced
½	green or red capsicum, cut in strips
2	eggs
4	green onions, chopped
	black pepper
1	small can prawns
1 tablespoon	soy sauce
6 cups	cooked rice

Method:

Place oil, garlic and ginger in a large shallow dish and cook on P10 for 30 to 40 seconds. Add carrot, celery and capsicum. Cook a further 2 minutes on P10. Break eggs into a small dish, add pepper to taste, mix well and cook on P7 for 1 to 1½ minutes. Slice into thin strips. Add eggs plus all remaining ingredients to vegetable mixture. Stir well and cook on P10 for 3 to 5 minutes to heat thoroughly. Serve.

Notes:

- 1 cup uncooked rice will yield 2 cups cooked rice.
- Cooked rice can be cooked using Sensor Cook functions.

HINT:**TO REHEAT 2 CUPS OF COOKED RICE:**

Add 1 to 2 tablespoons of water or a knob of butter and cook on P10 for 2 to 3 minutes.

CHICKEN RISOTTO

Serves: 4

Ingredients:

1	onion, sliced
2 cups	short grain rice
1 teaspoon	dried oregano
1 teaspoon	cracked black pepper
4 cups	chicken stock
¼	green capsicum, sliced
¼	red capsicum, sliced
200 g	mushrooms, sliced
½ cup	frozen peas
2	cooked chicken breast fillets, sliced
¼ cup	grated parmesan cheese

Method:

Place onion, rice, oregano, pepper and chicken stock into a 4-litre dish. Cook on P10 for 17 to 19 minutes. Add remaining ingredients, stir well and cook on P10 for 4 minutes. Serve.

PENNE PUTTANESCA

Serves: 4

Ingredients:

500 g	Penne Pasta
2 litres	boiling water
1 tablespoon	olive oil
3	cloves garlic, crushed
1 teaspoon	dried chilli flakes
1 kg (approx 5)	tomatoes, roughly chopped
200 g	kalamata olives, pitted
8	anchovy fillets, drained and chopped
⅓ cup	capers, drained and rinsed
⅓ cup	flat leaf parsley, chopped
2 tablespoons	finely shredded basil leaves

Method:

Place pasta and boiling water into a 4-litre dish. Stir and cook on P10 for 12 to 14 minutes or until tender. Drain and set aside. Place oil and garlic into a 2 litre dish and cook on P10 for 1 minutes. Stir in chilli and tomatoes. Cover and cook on P10 for 5 minutes, stir halfway through cooking. Add remaining ingredients and cook on P10 for a further 10 minutes or until tomatoes break down and sauce has thickened. Stir sauce into pasta. Cover and cook on P10 for 2 to 3 minutes to heat through. Season and serve topped with extra basil leaves or parsley.

CREAMY SUN-DRIED TOMATO PENNE

Serves: 4

Ingredients:

250 g	penne
6 cups	boiling water
½ cup	sun-dried tomatoes in oil, drained
1 cup	basil leaves
¼ cup	toasted pinenuts
⅓ cup	grated parmesan cheese
300 ml	cream
½ cup	sliced ham
¼ cup	grated parmesan cheese, extra

Method:

Place pasta and water in a 4-litre casserole dish. Cook on P10 for 14 to 16 minutes.

To cook by Sensor Cook:

Prepare as above. Cover securely with plastic wrap. Refer to Dried Pasta directions on page 23. Select **Dried Pasta**, then **Start**.

While pasta is cooking, prepare sauce. Place all ingredients except ham and extra parmesan cheese into a food processor. Process until smooth. Drain pasta and add sauce. Serve topped with ham and extra parmesan cheese.

Tip:

To toast ¼ cup pinenuts place into a small bowl. Cook on P10 for 3 to 4 minutes, stirring every minute.

SPAGHETTI WITH CHILLI TOMATO SAUCE

Serves: 4

Ingredients:

250 g	spaghetti
4 cups	boiling water
1 tablespoon	olive oil
1	onion, finely chopped
2	cloves garlic, crushed
425 g	can crushed tomatoes
2 teaspoons	crushed chillies
2 tablespoons	fresh chopped basil
1 teaspoon	pepper

Method:

Place spaghetti and water in a 3-litre casserole dish. Cook on P10 for 12 to 14 minutes.

To cook by Sensor Cook:

Prepare as above. Cover securely with plastic wrap. Refer to Dried Pasta directions on page 23. Select **Dried Pasta**, then **Start**.

Stand, covered, for 2 minutes. Drain. Place oil, onion and garlic in a 4-cup jug. Cook on P10 for 1 to 2 minutes. Add tomatoes, chillies, basil and pepper. Stir until combined. Cover and cook on P7 for 10 to 15 minutes, stirring halfway through cooking. Serve with spaghetti.

CREAMY BACON SAUCE

Makes: Approximately 300 ml

Ingredients:

1	onion, chopped
3	bacon rashers, chopped
1 teaspoon	minced garlic
300 ml	cream
¼ cup	Parmesan cheese
	pepper
2 tablespoons	chopped fresh parsley

Method:

Place onion, bacon and garlic in a 2-litre casserole dish. Cook on P10 for 4 to 5 minutes. Add cream, Parmesan cheese, pepper, parsley and stock. Mix well. Cook on P10 for 3 to 4 minutes. Serve with cooked Fettuccine.

MACARONI AND CHEESE

Serves: 4 to 6

Ingredients:

40 g	butter
1	onion, finely chopped
2 tablespoons	flour
2 cups	milk
1 cup	grated tasty cheese
6 cups	cooked macaroni, drained well
½ cup	extra grated tasty cheese
	paprika

Method:

Place butter and onion in a 2-litre casserole dish and cook on P10 for 3 to 5 minutes. Add flour, mix well and cook on P10 for 1 minute. Blend in milk and cook on P10 for 4 to 5 minutes, stirring halfway through cooking. Add cheese to sauce and season. Place macaroni and sauce in a 3-litre casserole dish. Mix well.

Top with extra cheese and sprinkle with paprika. Cook on P10 for 6 to 8 minutes.

SZECHUAN SALAD NOODLES**Ingredients:**

350 g	fresh Hokkien noodles
½ cup	boiling water
250 g	cooked chicken, shredded
½ cup	roasted cashew nuts

Dressing:

4	green onions, finely sliced
2 tablespoons	chopped coriander
2	cloves garlic, minced
2 tablespoons	smooth peanut butter
2 tablespoons	sweet chilli sauce
1 tablespoon	soy sauce
1 tablespoon	sweet sherry
2 teaspoons	sesame oil
2 tablespoons	olive oil
2 tablespoons	chicken stock
10	toasted szechuan peppercorns, ground

Method:

Place noodles in a bowl with the boiling water. Cook on P7 for 1 to 2 minutes. Drain and rinse under cold water. Drain well. Combine all dressing ingredients and whisk well. Combine noodles, chicken and cashew nuts and pour over dressing. Toss well to combine. Serve immediately.

TERIYAKI TOFU VEGETABLE NOODLES

Serves: 4

Ingredients:

1 tablespoon	sesame oil
350 g	firm tofu, diced
1	onion, cut into petals
300 g	stir fry vegetables
1 tablespoon	hoisin sauce
1 tablespoon	teriyaki sauce
85 g	2 minute noodles
2 cups	boiling water

Method:

Place oil, tofu and onion in a 3-litre dish and cook on P10 for 2 to 3 minutes. Add vegetables and sauces and cook on P10 for 3 to 4 minutes, stirring once during cooking. Place noodles and water in a 2-litre bowl and cook on P10 for 2 minutes. Stir and drain. Toss noodles through tofu and vegetables and serve.

Cakes, Desserts and slices can successfully be cooked in the microwave oven if a few simple rules are followed see individual recipes for instructions.

COOKING CAKES BY MICRO POWER

- The texture of cakes cooked in the microwave oven is not the same as cakes cooked in a conventional oven, but it is a convenient way of cooking cakes.
- Do not use metal cake tins, plastic dishes and pyrex, give the best results when cooking cakes. Grease the dish and line with paper towel or bake paper to absorb excess moisture.
- Round or oval shaped dishes produce the most even cooking results. Square cakes may need the corners shielded with foil to prevent overcooking.
- Choose light coloured cakes that can be iced or substitute brown sugar for white sugar and sprinkle the top of cake with spices to give a darker appearance.
- Do not fill cake pans more than half full. Microwaved cakes rise substantially more than conventionally cooked cakes.
- Cakes need to be well mixed but do not over beat. Creaming with an electric mixer or food processor is not necessary. Use a fork to mix as the microwave aerates the mixture as it cooks.
- Do not cover cakes as the top will steam.
- Cakes should be removed from the oven just before they look cooked as the cooking process will finish during standing time.
- Chocolate cakes cook slightly faster than plain cakes.
- Cakes containing a large amount of whisked egg white will not cook successfully in the microwave oven.

COOKING FRUIT BY MICRO POWER

FRUIT - Peel, slice, chop into even sized pieces. Place in shallow heatproof dish on turntable.				
Apples - poached	500 g	P10	8	Add 300 ml of water. Only half fill dish. Cover.
Apples - stewed	500 g	P10	6	Only half fill dish. Cover.
Peaches - poached	500 g	P10	4 - 5	Add 300 ml of water. Only half fill dish. Cover.
Pears - poached	500 g	P10	6 - 7	Add 300 ml of water. Only half fill dish. Cover.
Plums - poached	500 g	P10	8	Add 300 ml of water. Only half fill dish. Cover.
Plums - stewed	500 g	P10	8 - 10	Add 30 ml (2 tablespoon) of water. Only half fill dish. Cover.
Rhubarb - stewed	500 g	P10	5	Only half fill dish. Cover.

SULTANA CAKE

Serves: 4 to 6

Ingredients:

100 g	butter
1 cup	sultanas
1 cup	brown sugar
1 cup	milk
1	egg, beaten
2 cups	self-raising flour

Method:

Place butter, sultanas, brown sugar and milk in heat resistant mixing bowl. Cook on P10 for 3 to 4 minutes. Stir halfway through cooking. Allow to cool. Add egg and flour. Pour batter into base of lined 20 cm round dish. Cook on P6 for 9 to 11 minutes. Let cool, loosely covered, with plastic wrap on wire rack.

QUICK MIX CHOCOLATE CAKE

Serves: 4 to 6

Ingredients:

1 cup	self-raising flour
1 cup	caster sugar
2 tablespoons	cocoa
3 tablespoons	butter, softened
2	eggs
1/3 cup	milk

Method

Sift all dry ingredients into a bowl. Add butter, eggs and milk. Beat with wire whisk for 1 to 2 minutes. Grease 2-litre plastic ring mould and line with paper towel. Pour mixture into mould and cook on P7 for 5 to 7 minutes. Stand, covered, for 5 minutes before turning out. Cool on wire rack.

Tip: To soften butter cook on P5 for 10 to 20 seconds.

PACKET CAKE**Ingredients:**

1 packet cake mix (340 g)
 Ingredients as recommended by manufacturer.

Method:

Mix cake and other ingredients with a metal spoon. DO NOT OVERBEAT. Pour into 20 cm round dish that has been lightly greased and lined with paper. Cook on P8 for 5 to 7 minutes. Stand and allow to cool before removing.

Variations:

- 1 tablespoon jam added to batter before cooking.
- Add 1 cup sour cream to batter and halve water suggested by manufacturer.
- Half a cup chopped nuts, ¼ cup brown sugar and 1 teaspoon cinnamon. Mix and place on base of cake dish before cooking cake.
- Melt two tablespoons honey and 30 g butter in glass jug on P10 for 30 to 60 seconds. Pour over just baked buttercake. Sprinkle with cinnamon.
- Serve warm with cream or custard as a dessert or serve cold with cream as tea cake.
- A quarter cup of toasted muesli mixed with 1 tablespoon marmalade and placed in the base of the dish.

Tip: Packet cakes are best mixed by hand as the microwave will do the aerating.

CHOCOLATE SELF SAUCING PUDDING

Serves: 4

Ingredients:

1 cup	self raising flour
1 tablespoon	cocoa powder
⅓ cup	caster sugar
½ cup	milk
1 teaspoon	vanilla essence
100 g	chocolate
30 g	butter
¾ cup	brown sugar
2 tablespoons	cocoa, extra
¾ cup	water

Method:

Sift flour and cocoa into a 2-litre bowl. Add sugar, milk and vanilla essence. Mix well. Place chocolate and butter in a 2-cup pyrex jug and cook on P7 for 1 to 1½ minutes. Stir and add to mixture. Mix well. Spread mixture into base of a 2-litre casserole dish. Combine brown sugar, cocoa and water in 2-cup jug. Pour evenly over pudding. Cook on P10 for 4 to 6 minutes.

HINT:**TO MELT CHOCOLATE:**

Place 100 g broken chocolate in a 4-cup glass jug and heat on P5 for 1 to 2 minutes. As chocolate holds its shape after heating, stir and stand before adding extra cooking time.

APPLE CRUMBLE

Serves: 4

Ingredients:

1 (780 g)	can pie apples
½ cup	rolled oats
¼ cup	plain flour
½ cup	desiccated coconut
½ cup	brown sugar
1 teaspoon	cinnamon
60 g	butter

Method:

Place apples in the base of a 1-litre casserole dish. Place remaining ingredients (except butter) in mixing bowl. Melt butter in 2-cup jug on P10 for 40 to 60 seconds. Combine melted butter with dry ingredients and mix well. Spread evenly over apples. Cook on P10 for 5 to 8 minutes.

PEACH AND MUESLI CRUMBLE

Serves: 6 to 8

Ingredients:

80 g	butter
½ cup	flour
¼ cup	caster sugar
1½ cups	toasted muesli
½ cup	shredded coconut
½ teaspoon	cinnamon
810 g	peach slices, drained

Method:

Place butter in a 2-litre jug. Cook on P7 for 1 minute. Add flour, sugar, muesli, coconut and cinnamon, stir until combined. Place peaches into a 1-litre casserole dish. Place crumble mixture on top of peaches and cook on P10 for 10 to 12 minutes. Serve with cream or ice cream.

APRICOT COBBLER

Serves: 4 to 6

Ingredients:

1 (810 g)	can apricot halves, drained
1 (340 g)	packet butter cake mix
½ cup	toasted coconut
70 g	butter, melted

Method:

Arrange apricot halves on the base of 20 cm casserole dish. Combine cake mix, toasted coconut and butter. Sprinkle cake mixture over peaches. Cook on P10 for 6 to 8 minutes.

SWEET BERRY SAUCE

Makes: Approximately 2 cups

Ingredients:

½ cup	caster sugar
½ cup	water
500 g	berries, halved if large
2 tablespoons	water
1 tablespoon	cornflour

Method:

Combine sugar and water in a 3-litre bowl. Cook on P10 for 2 to 3 minutes. Add berries. Cook on P10 for 3 to 4 minutes. Blend water and cornflour. Mix into berry sauce. Cook on P10 for 2 minutes. Serve hot or cold with ice cream.

CINNAMON POACHED PEARS

Serves: 4

Ingredients:

½ cup	water
½ cup	caster sugar
½ teaspoon	cinnamon
4	pears, peeled and sliced

Method:

Combine water, caster sugar and cinnamon in a 1-litre jug. Cook on P10 for 2 minutes. Place the pears in a 2-litre dish. Pour over syrup and cover. Cook on P10 for 6 to 8 minutes.

Tip:

To soften butter cook on P5 for 10 to 20 seconds.

FIGS IN RIESLING AND HONEY

Serves 4

Ingredients:

8	firm figs
1½ cups	Riesling wine
80 ml	honey
1 teaspoon	lemon juice
1 teaspoon	grated lemon rind
2 tablespoons	chopped pistachio nuts

Method:

Wash and stem the figs place into a 2 litre dish. Combine Riesling, and honey and pour over figs. Cook on P7 for 6 to 8 minutes. Remove figs from syrup, set aside. Add lemon juice and rind to syrup and cook on P10 for 3 to 4 minutes or until slightly reduced. Pour syrup over figs and allow to cool. Serve with ice cream or cream and sprinkle with pistachio nuts.

FRUIT MINCE

Serves: 4

Ingredients:

250 g	mixed dried fruit
400 g	can crushed pineapple and juice
1	cooking apple peeled, cored and grated
1 cup	brown sugar
1 tablespoon	brandy
1 teaspoon	nutmeg
1 teaspoon	cinnamon
1 tablespoon	cornflour
¼ cup	water

Method:

Combine all ingredients (except cornflour and water) in a 2-litre casserole dish. Cook on P7 for 3 to 5 minutes. Blend cornflour with water and stir into fruit mixture. Cook on P10 for 3 to 5 minutes. Stir. Cool. Bottle and seal or use immediately.

INDIVIDUAL CHRISTMAS PUDDING

Makes: 8

Ingredients:

100 g	sultanas
150 g	raisins
50 g	craisins
100 g	dates, chopped
100 g	dried figs, chopped
50 g	glace ginger, chopped
½ cup	brandy
125 g	butter
¾ cup	firmly packed brown sugar
2	eggs
½ teaspoon	cinnamon
½ teaspoon	mixed spice
½ teaspoon	nutmeg
½ cup	plain flour
½ cup	pie apple
¾ cup	fresh breadcrumbs
1 tablespoon	golden syrup
1 tablespoon	parisienne essence

Method:

Place all dried fruits and brandy into a 2-litre bowl. Mix and cook uncovered on P3 for 10 minutes. Stir halfway through cooking. Cool. Beat butter and sugar in a large bowl with an electric mixer until light and fluffy. Add eggs, one at a time, beating between each addition. Stir in cooled fruits, then remaining ingredients. Grease 4 x 200 ml microwave safe cups. Place half a cup of mixture into each cup, pushing mixture in firmly. Smooth over the top of puddings with the back of a spoon. Place cups evenly around the edge of the microwave turntable and cook uncovered on P3 for 20 minutes. Stand for 5 minutes before turning out. Repeat with remaining mixture. Serve with cream or custard.

MINCE PIES • CAUTION

Take care not to overheat mince pies, otherwise burning can occur due to the high fat and sugar content of the filling. Check the temperature of the filling before consuming to avoid burning your mouth. REMEMBER even if the pastry is cold to the touch, the filling will be piping hot and will warm the pastry through.

CHOCOLATE PÂTÉ

Makes 24 x 8 cm loaf tin

Ingredients:

300 g	dark chocolate
400 g	can condensed milk
1 cup	brazil nuts
½ cup	hazelnuts
⅓ cup	glace cherries
½ cup	sultanas

Method:

Break chocolate into pieces and place with condensed milk in a 2-litre dish. Cook on P7 for 3 to 5 minutes, stirring twice during cooking. Fold through nuts and fruits. Line a 24 x 8 cm loaf tin with foil and pour in the mixture. Chill for several hours or until set. Turn out and serve thinly sliced.

STIRRED CUSTARD

Makes: Approximately 400 ml

Ingredients:

3 tablespoons	sugar
2 tablespoons	custard powder
1½ cups	milk
2	egg yolks, lightly beaten
1 teaspoon	vanilla essence

Method:

Combine sugar and custard powder in 4-cup jug. Gradually stir in milk until smooth. Cook on P6 for 4 to 5 minutes, stirring halfway through cooking. Add egg yolks and mix well. Cook on P6 for further 30 to 60 seconds. Add vanilla, stir well and serve.

BRANDY SAUCE

Makes: 1½ cups

Ingredients:

2 tablespoons	butter
2 tablespoons	cornflour
3 tablespoons	sugar
2 tablespoons	golden syrup
1 cup	milk
¼ cup	brandy

Method:

In a 1-litre pyrex jug melt butter on P10 for 20 to 30 seconds. Blend in cornflour, sugar and golden syrup and cook on P10 for 50 to 60 seconds. Add milk gradually and cook on P6 for 3 to 4 minutes. Stirring halfway through cooking. Stir in brandy. Serve hot with fruit or Christmas pudding.

CHOCOLATE BROWNIES

Makes: 1 x 20 cm square slice pan

Ingredients:

125 g	butter
200 g	chocolate
1 cup	caster sugar
1 teaspoon	vanilla essence
3	eggs
1 cup	plain flour

Method:

Grease and line 20 cm square pyrex dish. Melt butter and chocolate in 2-litre dish on P7 for 2 minutes. Stir in sugar, vanilla essence, eggs and flour. Spread into prepared dish. Cook on P7 for 5 to 6 minutes. Refrigerate until cold. Cut into squares.

RHUBARB, APPLE & GINGER COMPOTE

Serves: 4

Ingredients:

300 g	rhubarb, trimmed cut to 3 cm lengths
2	apples, peeled, cored and diced
30 g	crystallised ginger, thinly sliced
½ cup	caster sugar
1	orange, grated rind and juice

Method:

Place all ingredients into a 2-litre microwave safe dish. Stir to dissolve sugar. Cook on P10 for 8 to 10 minutes or until fruit is softened.

MOCHA FUDGE

Makes: 64 x 2.5 cm square pieces

Ingredients:

395 g	can sweetened condensed milk
300 g	dark chocolate melts
1 teaspoon	vanilla extract
1 teaspoon	instant coffee powder
64	chocolate coated coffee beans

Method:

Grease a square (20 cm) cake pan, set aside. Place condensed milk and chocolate in a 1.5-litre microwave safe and heatproof bowl. Cook on P7 for 2 minutes. Stir in vanilla and coffee. Mix until well combined. Cook on P5 for 2 minutes. Stir and pour into prepared pan. Arrange coffee beans evenly over the fudge. Chill for 2 hours or until set. Cut into 2.5 cm squares to serve.

Tip:

Chocolate coated coffee beans are available from specialty coffee shops.

PRESERVING PRECAUTIONS

Do not use your oven for home canning or the heating of any closed jar. Pressure will build up and the jar may explode. In addition, the microwave oven cannot maintain the food at the correct canning temperature. Improperly canned food may spoil and be dangerous to consume.

Jars and Bottles

Jars and bottles can be used to warm food to serving temperature. If the lid is removed first. Cooking should not be done in these containers since most are not heat resistant and during extended heating times, heat from food would cause cracking or breaking.

Thermometers are available for use in microwave ovens. DO NOT USE CONVENTIONAL MERCURY TYPE CANDY OR MEAT THERMOMETERS in food while cooking in the microwave oven.

Alternatively, a conventional meat thermometer may be used after the food is removed from the oven.

Sterilizing Jars

Jam jars can be sterilized by microwave ready for your jams. Half fill with water and heat them on P10 power until water boils (approx.3 mins, for 2 jars). Empty and drain upside down on kitchen paper. The jars should be warm when filled with jam.

TOMATO CHUTNEY

Makes: 3 cups (750 ml)

Ingredients:

250 g	onion, finely chopped
1.5 kg	ripe tomato, skins removed and chopped
1 teaspoon	salt
1 teaspoon	paprika
	pinch cayenne pepper
150 ml	malt vinegar
175 g	sugar

Method:

Place onions in a 3-litre dish. Cover. Cook on P10 for 4 to 5 minutes. Add tomatoes. Cover. Cook on P10 for 5 to 6 minutes. Add salt, spices and vinegar. Stir well. Cook on P10 for 10 minutes, stirring halfway through. Add sugar, stir well and cook on P7 for 35 to 40 minutes. Stirring occasionally. Pour into sterilised jars and seal.

LEMON BUTTER

Makes: 1 cup (250 ml)

Ingredients:

½ cup	lemon juice
1 tablespoon	lemon rind
⅓ cup	sugar
3	egg yolks
1 tablespoon	butter
1 tablespoon	cornflour

Method:

Blend all ingredients in a 4-cup glass jug. Cook on P6 for 4 to 5 minutes, stirring every minute. Pour into hot sterilised jars and seal immediately.

BASIC WHITE SAUCE

Makes: 1 cup

Ingredients:

2 tablespoons	butter
2 tablespoons	flour
	salt and white pepper
1¼ cups	milk

Method:

Place butter in a 4-cup jug. Cook on P10 for 30 to 40 seconds. Stir in flour, salt and pepper. Gradually add milk, stirring until smooth. Cook on P10 for 2 minutes, stirring every minute.

Tip: For cheese sauce, stir in ½ cup grated cheese once sauce has thickened.

GRAVY

Makes: 2 cups

Ingredients:

2 tablespoons	dripping or pan juice
1	small onion, finely chopped
2 tablespoons	flour
1 tablespoon	tomato paste
1½ cups	beef stock
	salt and pepper

Method:

Place dripping or pan juices and onion in a 2-cup jug. Cook on P10 for 2 minutes. Add flour, tomato paste and half of the beef stock. Stir well. Cook on P10 for 2 minutes. Add remaining stock. Stir well and cook on P10 for a further 2 minutes. Season with salt and pepper. Serve with the meat of your choice.

CHEESE SAUCE

Makes: 1½ cups

Ingredients:

40 g	butter
2 tablespoons	flour
1½ cups	milk
½ cup	grated cheese

Method:

Melt butter in 1-litre jug on P10 for 30 seconds. Add flour and mix well. Gradually stir in milk. Cook on P10 for 3 to 4 minutes. Stirring halfway through cooking. Add cheese and cook on P10 for a further 1 to 1½ minute. Stir and serve with vegetables of your choice.

HINT:**COOKING SAUCES:**

When making some sauces in the microwave oven, less liquid may be needed as less evaporation occurs with a shorter cooking time.

LEMON LIME CORDIAL

Makes: approximately 1.5 litres of undiluted cordial

Ingredients:

10	large lemons
6	limes
4 cups	sugar
2 cups	water
2 teaspoons	citric acid

Method:

Squeeze juice from lemons and limes. Place in a 3 to 4-litre dish with the remaining ingredients. Cook on P10 for 8 to 10 minutes. Stir 2 to 3 minutes during this cooking time to dissolve sugar. Cook on P10 for 25 to 30 minutes, or until the mixture has become a syrupy consistency. Set aside to cool. Pour into bottles and seal. Store in the refrigerator and serve with cold water, soda or mineral water and fresh mint leaves if desired.

RICH CHOCOLATE SAUCE

Makes: 1¼ cups

Ingredients:

200 g	chocolate pieces
300 ml	cream

Method:

Combine chocolate and cream in a 1-litre jug. Cook on P10 for 2 minutes. Mix well. Serve over ice cream.

STRAWBERRY LIQUEUR

Makes: 750 ml

Ingredients:

500 g	sugar
500 g	washed and hulled strawberries
600 g	brandy or whisky

Method:

Place sugar and strawberries in a 4-litre dish. Stir well. Cook on P10 for 15 minutes. Stir in brandy or whisky. Pour into an airtight container. Store refrigerated for 2 to 3 months. Serve in liqueur glasses or as a tall drink with ice cubes and soda water.

MINT SAUCE

Makes: Approximately ¼ cup

Ingredients:

¼ cup	water
1 tablespoon	sugar
2 tablespoons	brown vinegar
2 tablespoons	mint, finely chopped

Method:

Combine all ingredients in 1-cup jug. Cook on P10 for 30 to 60 seconds. Stir well and serve with Roast Lamb.