

**Panasonic**<sup>®</sup>

# Automatic Bread Maker

OPERATING INSTRUCTIONS AND RECIPES (Household Use)

Model No. **SD-ZB2512**



Thank you for purchasing this Panasonic product.

- Please read these instructions carefully before using this product and save this manual for future use.
- This product is intended for household use only.



Before Use

How to Use

Recipes

How to Clean

Troubleshooting

# Contents

---

## Before Use

● Safety Instructions	3
● Accessories/Parts Identification	6
● Bread-making Ingredients	8

---

## How to Use

● List of Bread Types and Baking Options	10
● Baking Bread	12
● When adding extra ingredients	14
● Baking Brioche	15
● Baking Savoury	16
● Rustic Sourdough/Rustic Sourdough Dough	
STAGE 1 Making Sourdough starter	18
STAGE 2 Baking Rustic Sourdough	19
STAGE 2 Making Rustic Sourdough Dough	20
● Making Dough	21
● Making Brioche Dough	22
● Making Savoury Dough	23
● Baking Rustic Scone	24
● Baking Cake	26
● Making Jam	27
● Making Compote	28

---

## Recipes

● Bread Recipes	29
● Gluten Free Recipes	33
● Dough Recipes	35
● Cake Recipes	43
● Jam Recipes	44
● Compote Recipes	44



---

## How to Clean

● Care & Cleaning	45
-------------------	----

---

## To Protect the Non-stick Finish

● To protect the non-stick finish	46
-----------------------------------	----

---

## Troubleshooting

● Troubleshooting	47
● WARRANTY	51
● Specification	52

# Safety Instructions Please make sure to follow these instructions.

In order to prevent accidents or injuries to the user, other people, and damage to property, please follow the instructions below.

■ **The following charts indicate the degree of damage caused by wrong operation.**



**Warning:** Indicates serious injury or death.



**Caution:** Indicates risk of injury or property damage.

■ **The symbols are classified and explained as follows.**



This symbol indicates prohibition.



This symbol indicates requirement that must be followed.



## Warning



**Do not use the appliance if the power cord or power plug is damaged or the power plug is loosely connected to the power outlet.**

(It may cause an electric shock, or fire due to short circuit.)

→ If the supply cord is damaged, it must be replaced by the manufacturer, its service agent or similarly qualified person in order to avoid a hazard.

**Do not damage the power cord or power plug.**

(It may cause an electric shock, or fire due to short circuit.)

Following actions are strictly prohibited. (Modifying, placing near heating elements, bending, twisting, pulling, putting heavy objects on top, and bundling the cord.)

**Do not plug or unplug the power cord with wet hands.**

(It may cause an electric shock.)

**Do not exceed voltage on the outlet and do not use alternate current other than listed on the appliance.**

(It may cause an electric shock or fire.)

- Make sure the voltage supplied to the appliance is the same as your local supply.
- Plugging other devices into the same outlet may cause an electric overheating.



**Insert the power plug firmly.**

(Otherwise it may cause an electric shock and fire caused by the heat that may generate around the plug.)

# Safety Instructions Please make sure to follow these instructions.

## **Warning**



### **Clean the power plug regularly.**

(A soiled power plug may cause insufficient insulation due to the moisture and lint build-up, which may cause a fire.)

→ Unplug the power plug, and wipe with the dry cloth.

### **Discontinue using the appliance immediately and unplug in the unlikely event that this appliance stops working properly.**

(It may cause smoking, fire, electric shock or burn.)

e.g. for abnormal or breaking down

- The power plug and the power cord become abnormally hot.
- The power cord is damaged or power failure.
- The main body is deformed or is abnormally hot.
- The appliance makes abnormal turning noise during use.

→ Unplug the appliance immediately and consult a Panasonic dealer and have it serviced by an authorised technician.



### **Do not touch, block or cover the steam vent holes during use.**

(It may cause a burn.)

- Especially pay attention for children.

### **Do not disassemble, repair or modify this appliance.**

(It may cause a fire, electric shock or injury.)

→ Consult a Panasonic dealer and have it serviced by an authorised technician.

### **Do not immerse the appliance in water or splash it with water.**

(It may cause an electric shock, or catch a fire due to short circuit.)



**This appliance is not intended for use by persons (including children) with reduced physical, sensory or mental capabilities, or lack of experience and knowledge, unless they have been given supervision or instruction concerning use of the appliance by a person responsible for their safety.**

**Children should be supervised to ensure that they do not play with the appliance.**

(It may cause burns, injury or electric shock.)

## **Caution**



### **Make sure to hold the power plug when unplugging the power plug.**

(Otherwise it may cause an electric shock, or fire due to short circuit.)

## Caution

-  **Unplug the power plug when the appliance is not in use.** (Otherwise it may cause an electric shock, or fire due to electric leakage.)

**Please unplug and allow the appliance to cool down before cleaning it.** (It may cause a burn.)

-  **Do not allow the power cord to hang over the edge of the table or touch a hot surface.** (It may cause a burn or injury.)

**Do not remove the bread pan or unplug the Bread Maker during use.** (It may cause a burn or injury.)

**Do not use the appliance on following places.**

- Position the Bread Maker on a firm, dry, clean, flat heatproof worktop at least 10 cm (4 inches) from the edge of the worktop. (It may cause the appliance to slip and fall from the worktop.)
- Do not place on uneven surfaces, on electrical appliances such as a refrigerator, on materials such as tablecloths or on carpet, etc. (It may cause falling or a fire.)
- During baking the unit heats up. The Bread Maker should be placed at least 5 cm (2 inches) from adjacent walls and other objects. (It may cause a discolouration or deformation.)

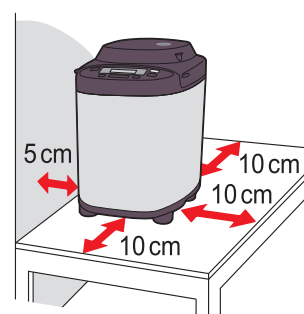

**Do not touch hot area such as bread pan, inside of unit, heating element or inside of the lid while the appliance is in use or after cooking.**

**The temperature of accessible surfaces may be high when the appliance is operating.**

(The surfaces get hot during use which cause burns.)

→ To avoid burns, always use oven gloves when removing the bread pan or the finished bread. (Do not use wet oven gloves.)

Also take care when removing the finished bread or kneading blade.

**Do not use an external timer etc.**

- This appliance is not intended to be operated by means of an external timer or separate remote-control system. (It may cause a burn or injury.)

### Important Information

- Do not use the appliance outdoors, in the immediate vicinity of heat sources or in rooms of high humidity. (It may cause a malfunction or deformation.)
- Do not use excessive force on the parts as is illustrated on the right. (It may cause a malfunction or deformation.)

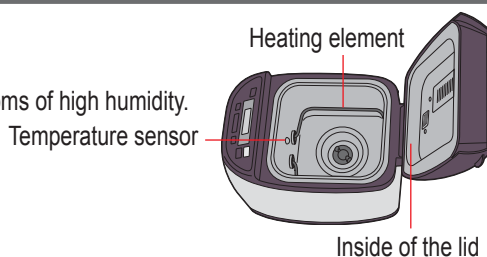

This symbol on the product indicates “hot surface and should not be touched without caution”.

## Raisin nut dispenser

The ingredients placed in the raisin nut dispenser will drop into the bread pan automatically upon selecting the menu with raisin (3, 4, 7, 16, 20, 21, 23 and 31).

Turn to P. 14 for ingredients which may be placed in the raisin nut dispenser.  
Never operate the Bread Maker without the dispenser being in place.



Dispenser lid  
Yeast dispenser

Lid  
Raisin nut dispenser flap  
Kneading blade (rye bread)  
Kneading blade (wheat bread)  
Handle  
Bread pan

Control panel



Plug

## Accessories

**Sourdough cup × 2**  
To measure out liquids, make sourdough starter

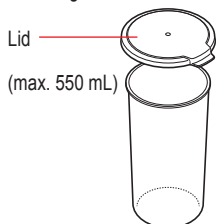

Lid  
(max. 550 mL)

• 10 mL increments

**Measuring spoon**  
To measure out sugar, salt, yeast, etc.  
(15 mL) (5 mL)

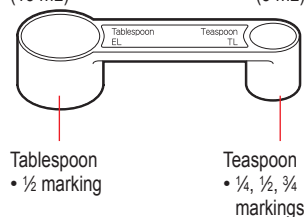

Tablespoon  
• ½ marking

Teaspoon  
• ¼, ½, ¾ markings

**Sourdough starter spoon**  
To measure out sourdough starter yeast  
approx. 0.1 g



# Control Panel

## ■ Operation status

- : displayed for the current stage of the programme. Ingredients are being regulated on the 'Rest' stage before kneading.
- ⚡ : displayed when there is a problem with the power supply.
- 👤 : displayed when adding ingredients manually on menu 4, 13, 21 and 29.

## ■ Time remaining until ready

Also when adding ingredients manually, display will show the time until adding extra ingredients in the programme.



Before Use

### Size

Press this pad to choose size. See P. 10 for available menu.

- XL
- L
- M

### Crust

Press this pad to choose crust colour. See P. 10 for available menu.

- Dark
- Medium
- Light

### Start

The start light will flash during programme selection. Press the start pad when programming is completed. When the start pad is pressed, the start light will stop flashing and become constant.

### Menu

Press this pad to choose menu. Menu number will display and each time this pad is pressed, menu number will change to the next choice. (Hold the pad to advance more quickly) See P. 10 and 11 for menu number.

### Timer

Set delay timer (time until bread is ready) or set the baking/cooking time for menu 18, 32 and 33.

- ‘▲’ Press this pad to increase the time.
- ‘▼’ Press this pad to decrease the time.

### Stop

If you wish to change the programme, you must stop the operation by holding down the stop pad for more than 1 second. The start light will go off. Then re-programme accordingly.

# Bread-making Ingredients

## Flour

Main ingredient of bread, produces gluten. (helps the bread to rise, gives it a firm texture)

- Use strong flour. Do not use soft or plain flour.
- Flour must be weighed on scales.

Strong flour is milled from hard wheat and has a high content of protein which is necessary for the development of gluten. Carbon dioxide produced during fermentation is trapped within the elastic network of gluten, thus making the dough rise.

## Bread flour

Made by grinding wheat kernel, excluding bran and germ. The best kind of flour for baking bread is a flour marked 'for bread baking'.

- Do not use plain or self-raising flour as a substitute for bread flour.

## Whole wheat flour

Made by grinding entire wheat kernel, including bran and germ. Makes very health-giving bread. This bread is lower in height and heavier than bread baked with bread flour.

## Rye flour

Made by grinding rye kernel. Contains more iron, magnesium and potassium, which are necessary for human's health, than bread flour. But there isn't enough gluten. Makes dense, heavy bread. Do not use more than stated quantity (could overload motor). (use in menu 8 or 24)

## Spelt flour

In the wheat family but is a completely different species genetically. Although it contains gluten some gluten-intolerant people can digest it. (Consult your doctor.) Makes loaves with a flat/slightly sunken crust. Spelt wholegrain flour bread becomes low height and dense compared with spelt white flour bread. We will recommend spelt white flour to be used more than the half of the entire flour.

- There is Spelt (*Triticum spelta*) suitable for baking bread and Einkorn wheat (*Triticum monococcum*: also it is called small spelt) which is not suitable for baking bread are sold as spelt. Please use spelt. (use in menu 15, 16, 30, or 31)

## Other flour

Products milled from other grains (i.e. corn meal, rice, millet, soy, oat, buckwheat, barley flours).

- Do not use more than stated quantity (hinders rising and texture).
- Should not be used as substitute for bread flour.
- Gluten Free - see P. 33.
- Coarse ingredients such as flours with whole grains or the addition of nuts and seeds may damage the bread pan's non-stick finish.

## Brown flour

10-15% of wheat grain removed during milling.



## Dairy Products

Add flavour and nutritional value.

- If you use milk instead of water, the nutritional value of the bread will be higher, but do not use in timer setting as it may not keep fresh overnight.  
→ Reduce the amount of water proportionally to the amount of milk.



## Water

- Use normal tap water.
- Use tepid water if using menu 2, 6, 8, 14 or 24 in a cold room.
- Use chilled water if using menu 8, 9, 13, 15, 16, 24, 25, 29, 30 or 31 in a hot room.
- Always measure out liquids using the sourdough cup provided.

## Salt

Improves the flavour and strengthens gluten to help the bread rise.

- The bread may lose size/flavour if measuring is inaccurate.

## Fat

Adds flavour and softness to the bread.

- Using butter (unsalted) or margarine is recommended.

## Sugar

(granulated sugar, brown sugar, honey, treacle etc)

Food for the yeast, sweetens and adds flavour to the bread, changes the colour of the crust.

- Use less sugar if using raisins or other fruits, which contain fructose.

## If using a bread mix...

### ■ Bread mixes including yeast

- ① Place a 500 g mix in the bread pan, then add water. (Follow instructions on the packet for the quantity of water)
- ② Select menu 2- 'Large' size setting.
  - With some mixes, it is not clear how much yeast is included, so some trial and error may be required to obtain optimum results.

### ■ Bread mix with separate yeast sachet

- ① First place the bread mix in the bread pan, then the water. Then place the measured yeast in the yeast dispenser.
  - Bread Maker Capacity  
400–600 g mix (for a loaf), 250–600 g mix (for a dough)
- ② Set the machine according to the type of flour included in the mix, and start the baking.
  - Bread flour, brown flour → menu 1
  - Whole wheat, multigrain flour → menu 5
  - rye flour → menu 8

### ■ Baking brioche with brioche mix

- Select the menu 13 or 2 'MEDIUM' size-'LIGHT' crust colour. (P. 49)

### ■ You can make your bread taste better by adding other ingredients:

Eggs	Improve the nutritional value and colouring of the bread. (Water amount must be reduced proportionally) Beat eggs when adding them.
Bran	Increases the bread's fibre content. • Use max. 50 g.
Wheat germ	Gives the bread a nuttier flavour. • Use max. 50 g.
Spices, herbs	Enhance the flavour of the bread. • Only use a small amount (1–2 tbsps).



## Dry Yeast

Enables the bread to rise.

- Be sure to use dry yeast that does not require pre-fermentation (do not use fresh yeast or dry yeast requiring fermentation before using)
- Yeast which has 'Easy Blend', 'Fast Action' or 'Easy Bake' written on the packet is recommended.
- When using yeast from sachets, seal the sachet again immediately after use, and keep in the refrigerator. To store follow manufacturers instructions but use opened individual sachets within 48 hours.

# List of Bread Types and Baking Options

## ■ Function Availability and Time Required

• Time required for each process will differ according to room temperature.

Menu Number	Menu	Options			Processes					
		Size	Crust	Timer	Rest	Knead	Rise	Bake	Total	
Bake	1	Basic	●	●	●	30 min–60 min	15–30 min *4	1 hr 50 min–2 hr 20 min	50–55 min	4 hr–4 hr 5 min
	2	Basic Rapid	●	●	—	—	15–20 min	approx. 1 hour	35–40 min	1 hr 55 min–2 hr
	3	Basic Raisin	●	●*1	●	30 min–60 min	15–30 min *4	1 hr 50 min–2 hr 20 min	50 min	4 hours
	4	Savoury	●	●	●	30 min–60 min	25–30 min *4	1 hr 45 min–2 hr 10 min	50–55 min	4 hr–4 hr 5 min
	5	Whole wheat	●	—	●	1 hr–1 hr 40 min	15–25 min *4	2 hr 10 min–2 hr 50 min	50 min	5 hours
	6	Whole wheat Rapid	●	—	—	15 min–25 min	15–25 min *4	1 hr 30 min–1 hr 40 min	45 min	3 hours
	7	Whole wheat Raisin	●	—	●	1 hr–1 hr 40 min	15–25 min *4	2 hr 10 min–2 hr 50 min	50 min	5 hours
	8	Rye	—	—	●	45 min–60 min	approx. 10 min	1 hr 20 min–1 hr 35 min	1 hour	3 hr 30 min
	9	French	—	—	●	40 min–2 hr 5 min	10–20 min	2 hr 45 min–4 hr 10 min	55 min	6 hours
	10	Rustic Sourdough	—	—	●*3	0 min–55 min	45–55 min *5	2 hr 25 min–3 hr 10 min	55 min	5 hours
	11	Italian	—	—	●	30 min–1 hr	10–15 min	2 hr 25 min–3 hr	50 min	4 hr 30 min
	12	Sandwich	—	—	●	1 hr–1 hr 40 min	15–25 min *4	2 hr 10 min–2 hr 50 min	50 min	5 hours
	13	Brioche	—	●*1	—	30 min	25–45 min *4	1 hr 25 min	50 min	3 hr 30 min
	14	Gluten Free	—	●*2	—	—	15–20 min	40–45 min	50–55 min	1 hr 50 min–1 hr 55 min
	15	Speciality	●	—	●	30 min–1 hr 15 min	15–30 min *4	1 hr 50 min–2 hr 45 min	55 min	4 hr 30 min
	16	Speciality Raisin	●	—	●	30 min–1 hr 15 min	15–30 min *4	1 hr 50 min–2 hr 45 min	55 min	4 hr 30 min
	17	Rustic Scone	—	—	—	—	10 min	—	65 min	1 hr 15 min
	18	Bake only	—	—	—	—	—	—	30 min–1 hr 30 min	30 min–1 hr 30 min

\*1 Only 'Light' or 'Medium' available.

\*2 Only 'Medium' or 'Dark' available.

\*3 Can be set up to 9 hours, all others up to 13 hours.

\*4 There is a period of rise during the knead period.

\*5 There is a period of rest during the knead period.

• The Bread Maker will operate for a short time during the rise period (to ensure optimal gluten development).

		Options			Processes					
Menu Number	Menu	Size	Crust	Timer	Rest	Knead	Rise	Bake	Total	
Dough	19	Basic	—	—	—	30 min– 50 min	15–30 min*4	1 hr 10 min– 1 hr 30 min	—	2 hr 20 min
	20	Basic Raisin	—	—	—	30 min– 50 min	15–30 min*4	1 hr 10 min– 1 hr 30 min	—	2 hr 20 min
	21	Savoury	—	—	—	30 min– 50 min	25–30 min*4	1 hr 5 min– 1 hr 20 min	—	2 hr 20 min
	22	Whole wheat	—	—	—	55 min– 1 hr 25 min	15–25 min*4	1 hr 30 min– 2 hr	—	3 hr 15 min
	23	Whole wheat Raisin	—	—	—	55 min– 1 hr 25 min	15–25 min*4	1 hr 30 min– 2 hr	—	3 hr 15 min
	24	Rye	—	—	—	45 min– 60 min	approx. 10 min	—	—	2 hours
	25	French	—	—	—	40 min– 1 hr 45 min	10–20 min	1 hr 35 min– 2 hr 40 min	—	3 hr 35 min
	26	Rustic Sourdough	—	—	—	0–40 min	45–55 min	1 hr 5 min– 1 hr 35 min	—	2 hr 30 min
	27	Sourdough starter	—	—	—	—	—	24 hours	—	24 hours
	28	Pizza	—	—	●	(Knead) 10–18 min	(Rise) 7–15 min	(Knead) approx. 10 min	(Rise) approx. 10 min	45 min
	29	Brioche	—	—	—	30 min	25–45 min*4	35 min	—	1 hr 50 min
	30	Speciality	—	—	—	30 min– 1 hr 5 min	15–30 min*4	1 hr 10 min– 1 hr 55 min	—	2 hr 45 min
	31	Speciality Raisin	—	—	—	30 min– 1 hr 5 min	15–30 min*4	1 hr 10 min– 1 hr 55 min	—	2 hr 45 min
	32	Jam	—	—	—	—	—	—	—	1 hr 30 min– 2 hr 30 min
33	Compote	—	—	—	—	—	—	—	1 hr– 1 hr 40 min	

# Baking Bread



## Place the ingredients in the bread pan



### 1 Remove the bread pan and set the kneading blade

Remove the bread pan and

### set the kneading blade

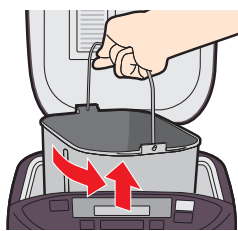

- ① Twist the bread pan round.
- ② Remove the bread pan.

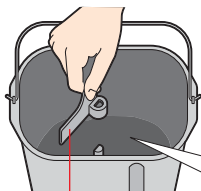

- ③ Place the kneading blade firmly into the shaft.

Check around the shaft and inside the kneading blade and ensure that they are clean. (P. 45)

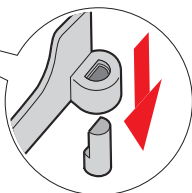

- When baking rye bread, use the specified kneading blade.
- The kneading blade fits loosely into place, but it must touch the bottom of the bread pan.

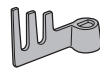

### 2 Place the measured ingredients in the bread pan

in the bread pan

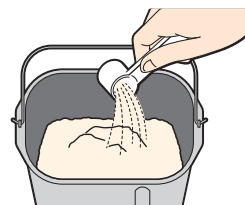

- ① Place the dry ingredients except dry yeast. (flour, sugar, salt, etc.)
  - Flour must be weighed on scales.



- ② Pour in the water and any other liquids.

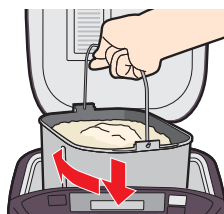

- ③ Wipe off any moisture and flour from the outside of the bread pan.

- ④ Place the bread pan inside the Bread Maker by turning it slightly from right to left. Fold the handle down.

- ⑤ Close the lid.
  - Don't open the lid until bread is complete (affects bread quality).

### 3 Place the dry yeast in the yeast dispenser

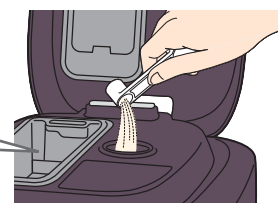

If the yeast dispenser is wet, absorb wetness with tissue etc. (Do not rub the yeast dispenser, otherwise the yeast will not drop into the bread pan due to static.)

### 4 Plug the Bread Maker into a 230-240 V socket



#### Baking bread with added ingredients (P. 14)



Clean and dry beforehand

- ① Open the dispenser lid.
- ② Place the ingredients.
- ③ Close the lid.

## Set the programme and start



## Remove the bread



### 5 Select a bake menu

(The display shows when menu '1' is selected.)

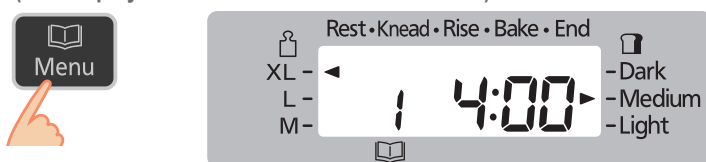

■ To change the size

■ To change the crust colour

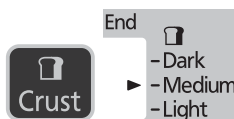
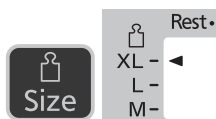

● Turn to P. 10 for menu, availability of size and crust.

■ To set the timer →

e.g. It is 9:00 PM now, and you want the bread to be ready at 6:30 the next morning.

→ Set the timer to '9:30' (9 hours 30 minutes from now).

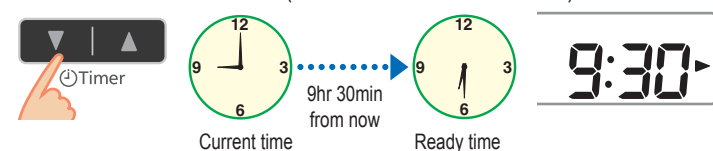

- Pressing the pad once will advance the timer by 10 minutes (hold to advance more quickly).
- Can be set up to 9 hours when using menu 10.

### 6 Press 'Start'

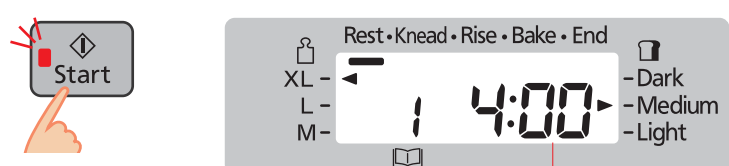

Estimated time until the selected programme is complete

● When 'Start' was pressed at first, menu 1 will start.

### 7 Turn off the power

when the bread is ready (machine beeps 8 times and the bar at 'End' flashes.)



### 8 Remove the bread immediately,

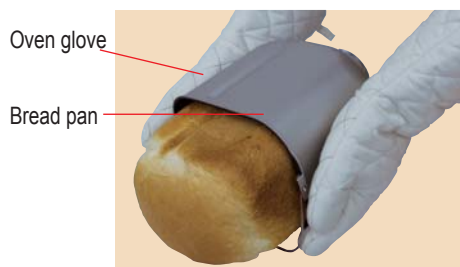

allow to cool, for example, on a wire rack

### 9 Unplug (holding the plug) after use

- If you do not press 'stop' and remove the bread from the unit to cool it, the Bread Maker will proceed to keep warm to reduce condensation of steam within the loaf.
- However, this will accelerate the browning of the crust, therefore, upon completion of baking, switch off the unit, remove the bread immediately from the unit to cool it.
- If you leave the bread to cool down in the bread pan, it will cause condensation. Therefore, cool on a wire rack to ensure optimum quality of the loaf.

# When adding extra ingredients

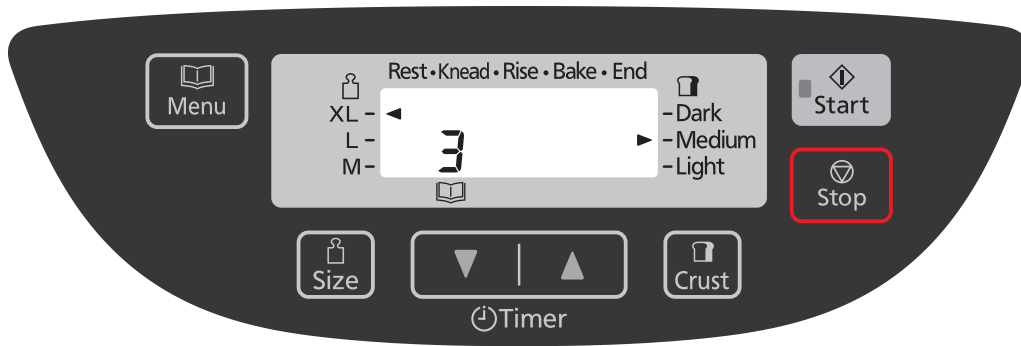

## Adding extra ingredients to bread or dough

By selecting a menu with Raisin (3, 4, 7, 16, 20, 21, 23 or 31), you can mix your favourite ingredients into the dough to make all kinds of flavoured breads.

Simply place the extra ingredients in the dispenser or the bread pan before start



### Dry ingredients, insoluble ingredients

→ Place the extra ingredients in the raisin nut dispenser and set the machine.

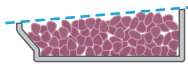

Correct

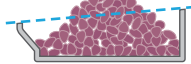

Incorrect

→ Do not overfill the raisin nut dispenser.



#### Dried fruits



- Cut up roughly into approx. 5mm cubes.
- Sugar-coated ingredients may stick to the raisin nut dispenser and not fall into the bread pan.

#### Nuts



- Chop finely.
- Nuts impair the effect of gluten, so avoid using too much.

#### Seeds

- Using large, hard seeds may scratch the coating of the dispenser and bread pan.

#### Herbs

- Use up to 1–2 tbsp of dried herbs. For fresh herbs, follow the instructions in the recipe.

#### Bacon, salami, olive, dry tomato

- Sometimes oily ingredients may stick to the raisin nut dispenser and not fall into the bread pan.
- Cut the bacon and the salami into 1 cm cubes.
- Cut the olive into ¼.
- Recommended to the course of Savoury.

### Moist/viscous ingredients, soluble ingredients\*

→ Place these ingredients together with the others into the bread pan.



#### Fresh fruits, fruits pickled in alcohol



- Only use quantities as in the recipe, as the water content of the ingredients will affect your bread.

#### Cheese, chocolate



\* These ingredients cannot be placed in the raisin nut dispenser as they would stick to it and not fall into the bread pan.

- Chop chocolate finely.
- Cut the cheese into 1 cm cubes.
- Recommended to the course of Savoury.

• Follow the recipe for the quantities for each ingredient.

# Baking Brioche



Bread flour	400 g
Salt	1 tsp
Sugar	3 tbsp
Butter (Cut into 2 cm cubes and keep in refrigerator)	50 g
Powdered milk	2 tbsp
Eggs (Medium)	2 (100 g)
Water	180 mL
Dry yeast	1½ tsp
* Butter for added later (Cut into 1–2 cm cubes and keep in refrigerator)	70 g

• For addition of ingredients with\*, follow programming instructions below.

- Preparations (P. 12)
- ① Cut the butter for adding later for 1–2 cm cubes and keep them in refrigerator.
  - ② Set the kneading blade into the bread pan.
  - ③ Place the ingredients in the bread pan in the order listed in the recipe.
  - ④ Set the bread pan into the main unit, and plug the machine into the socket.

## 1 Select menu '13'

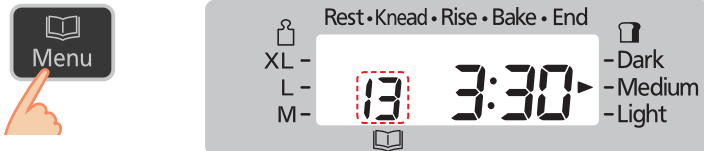

## 2 Start the machine

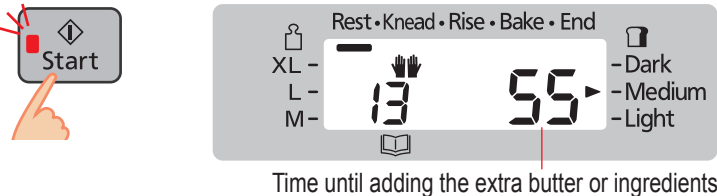

- The start light will come on.

## 3 Add additional butter when the beep sounds, then press 'Start' again

Complete placing the additional cubed butter while '👏' is flashing.

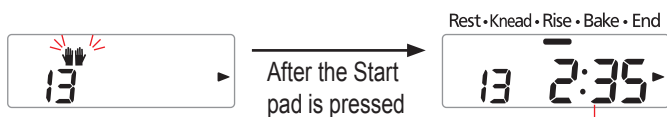

Display indicates remaining time until completion of the programme

## 4 Press 'Stop' and remove bread

when machine beeps 8 times and the bar at 'End' flashes

- The flashing start light will go off.

### [Simple way to bake brioche] Add butter with other ingredients at the beginning.

- Cut the butter into 2 cm cubes and place them into the bread pan at the same time as the other ingredients.
  - Follow the steps shown on the left. However, when the machine beeps on step 3 to add extra butter, please leave as it is.
  - Time required for completion is 3 hrs 30 minutes.
- \*When butter is added at the beginning, flavour, texture and rising of bread are a little different from the time bread is baked with extra butter added in later.
- A 'Rest' process will begin immediately after starting, followed by 'Knead' and 'Rise'.

- When adding extra ingredients such as raisins, add them with the butter. (Use max. 150 g for ingredients)
- Even without pressing the Start pad, kneading will continue after 5 min. It does not continue kneading immediately, even if the Start pad is pressed after adding butter or ingredients.
- Do not add butter after display shows remaining time. (P. 49)

# Baking Savoury



■ To cancel/stop once started  
(hold for more than 1 second)

1

2, 3 4

Preparations  
(P. 12)

- ① Set the kneading blade into the bread pan.
- ② Place the ingredients in the bread pan in the order listed in the recipe.
- ③ Set the bread pan into the main unit, and plug the machine into the socket.

## 1 Select menu '4'



## 2 Start the machine



- The start light will come on.
- Remaining time until placing the extra ingredients is displayed, after the time for placing is settled.



Time until adding the extra ingredients  
\*The above is for high-temperature case.  
'28' is displayed in low-temperature case.





Turn to P. 30 for bread recipes

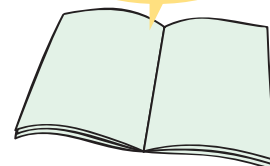

### 3 Add additional ingredients when the beep sounds, then press 'Start' again

Complete placing the extra ingredients while '👏👏' is flashing. Even without add extra ingredients and pressing the Start pad, 'Knead' and 'Bake' starts automatically after 5 min.

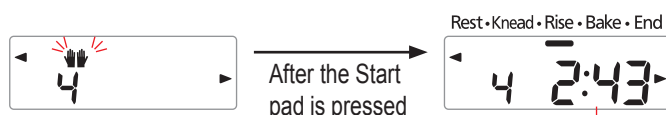

Display indicates remaining time until completion of the programme

\*The above is for high-temperature case.

Remaining time is changed depending on the room temperature.

Low-temperature: 3:00–3:03

High-temperature: 2:40–2:43

### 4 Press 'Stop' and remove bread

when machine beeps 8 times and the bar at 'End' flashes

- The flashing start light will go off.

- For ingredients, use max. 100 g as size-M, 125 g as size-L or 150 g as size-XL.

- Even without pressing the Start pad, kneading will continue after 5 min. It does not continue kneading immediately, even if the Start pad is pressed after adding ingredients.

- Do not add ingredients after display shows remaining time. (P. 49)

- Add automatically and manually extra ingredients list

Add automatically: Bacon, Olive, Green bean

Add manually: Cheese, Chocolate (frozen), Onions (finely diced)

# Rustic Sourdough/Rustic Sourdough Dough

## STAGE 1 Making Sourdough starter



1

2 3

Preparations  
(P. 12)

- ① Mix all the ingredients well in the sourdough cup.  
(Remove the kneading blade)
- ② Put the lid on the sourdough cup.
- ③ Place the sourdough cup in the bread pan.
- ④ Set the bread pan into the main unit, and plug the machine into the socket.

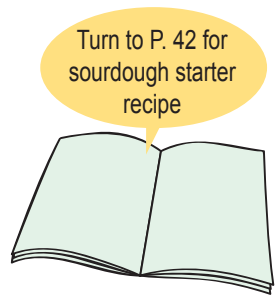

- To cancel/stop once started  
(hold for more than 1 second)

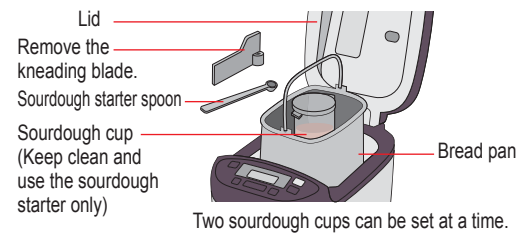

### 1 Select menu '27'



### 2 Start the machine



Estimated time until the selected programme is complete

- The start light will come on.



### 3 Press 'Stop' and remove the sourdough cup immediately

when machine beeps 8 times and the bar at 'End' flashes

- The flashing start light will go off.

### Store the sourdough starter in the refrigerator

- If you leave the sourdough starter in the bread maker, fermenting power decreases and the bread dose not rise.
- Make sure to store it in the refrigerator, and use up all within 1 week.  
(If the sourdough starter is stored in the freezer or at room temperature, fermenting power is lost.)

- Timer is not available on menu 27.
- If you select a wrong menu, the sourdough cup would be melted.

- Do not take out the sourdough cup until the programme is complete.

- Do not mix the new sourdough starter and the old sourdough starter.
- If the sourdough starter is made well, it smells sour and like alcohol.  
(When the room temperature is over 30°C, the sourdough starter goes bad.)

# STAGE 2 Baking Rustic Sourdough

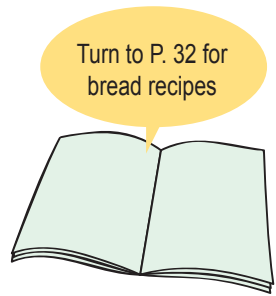

■ To cancel/stop once started (hold for more than 1 second)

Preparations (P. 12)

- ① Set the kneading blade into the bread pan.
- ② Tip the sourdough starter in the bread pan.
- ③ Place the ingredients in the bread pan in the following order: bread flour → salt → water.
- ④ Set the bread pan into the main unit, and plug the machine into the socket.
- ⑤ Place the dry yeast in the yeast dispenser.

## 1 Select menu '10'



## 2 Start the machine



Estimated time until the selected programme is complete

- The start light will come on.



## 3 Press 'Stop' and remove bread

- when machine beeps 8 times and the bar at 'End' flashes
- The flashing start light will go off.

- When the room temperature is over 30°C, the bread does not turn out well.

# Rustic Sourdough/Rustic Sourdough Dough

## STAGE 2 Making Rustic Sourdough Dough



Turn to P. 35 for dough recipes

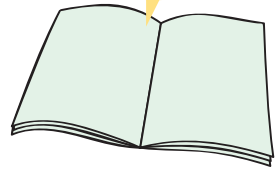

■ To cancel/stop once started  
(hold for more than 1 second)

1

2 3

Preparations  
(P. 12)

- ① Set the kneading blade into the bread pan.
- ② Tip the sourdough starter in the bread pan.
- ③ Place the ingredients in the bread pan in the following order:  
bread flour → salt → water.
- ④ Set the bread pan into the main unit, and plug the machine into the socket.
- ⑤ Place the dry yeast in the yeast dispenser.

### 1 Select menu '26'



- Timer is not available on Dough menus (except menu 28).

### 2 Start the machine

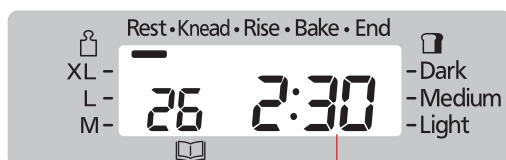

Estimated time until the selected programme is complete

- The start light will come on.



### 3 Press 'Stop' and remove dough

- when machine beeps 8 times and the bar at 'End' flashes
- The flashing start light will go off.

- Shape the finished dough and allow it to rise for the second time according to the recipe, then bake in the oven.

# Making Dough



Turn to P. 35 for dough recipes



■ To cancel/stop once started (hold for more than 1 second)

Preparations (P. 12)

- ① Place the kneading blade into the bread pan.
- ② Place the ingredients in the bread pan in the order listed in the recipe.
- ③ Set the bread pan into the main unit, and plug the machine into the socket.

## 1 Select dough menu

(The display shows when menu '19' is selected.)

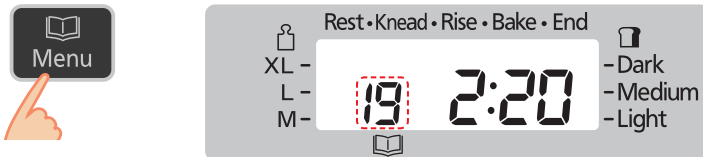

## 2 Start the machine

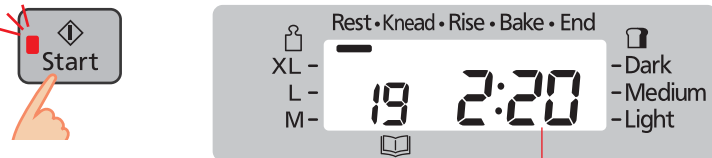

Estimated time until the selected programme is complete

- The start light will come on.



## 3 Press 'Stop' and remove dough

- when machine beeps 8 times and the bar at 'End' flashes
- The flashing start light will go off.

- Timer is not available on Dough menus (except menu 28).
- If you would like to add extra ingredients to your dough, see P. 14.

- For menus other than 27, 28, 32 and 33, a 'Rest' process will begin immediately after starting, followed by 'Knead' and 'Rise'.

- Shape the finished dough and allow it to rise for the second time according to the recipe, then bake in the oven.

# Making Brioche Dough

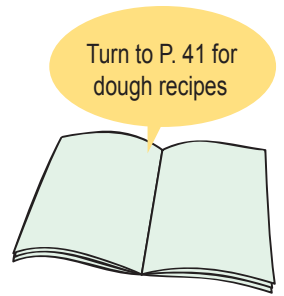
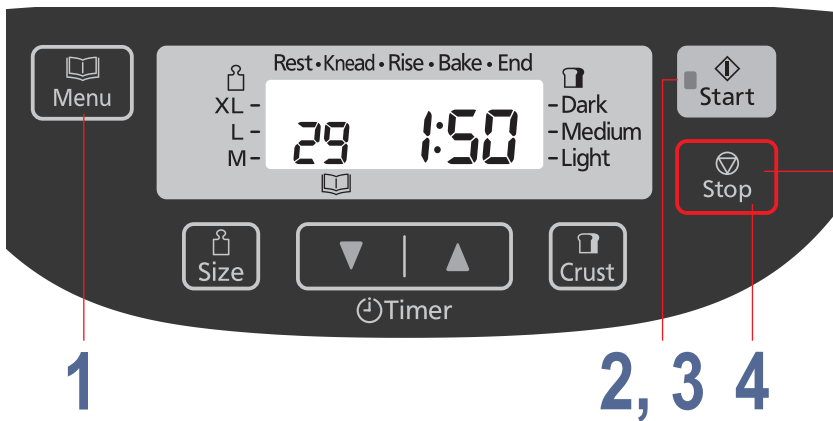

■ To cancel/stop once started (hold for more than 1 second)

- Preparations (P. 12)
- ① Cut the butter for adding later for 1–2 cm cubes and keep them in refrigerator.
  - ② Set the kneading blade into the bread pan.
  - ③ Place the ingredients in the bread pan in the order listed in the recipe.
  - ④ Set the bread pan into the main unit, and plug the machine into the socket.

## 1 Select menu '29'

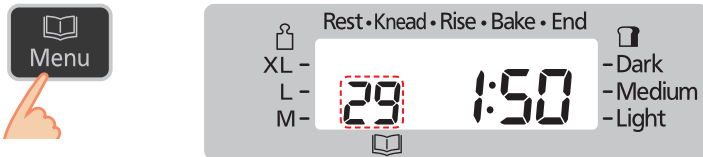

## 2 Start the machine

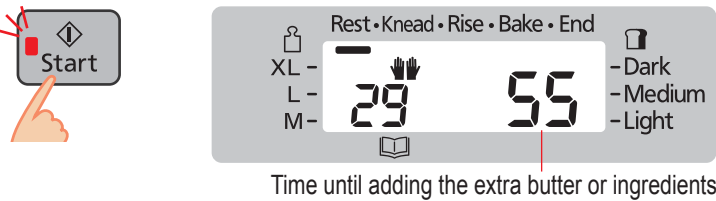

- The start light will come on.



## 3 Add additional butter when the beep sounds, then press 'Start' again

Complete placing the additional cubed butter while '👏' is flashing.

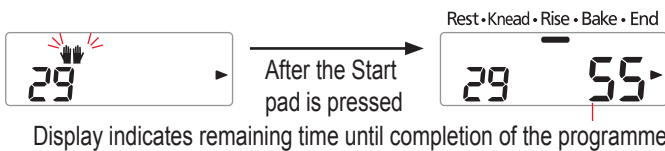

## 4 Press 'Stop' and remove dough

when machine beeps 8 times and the bar at 'End' flashes

- The flashing start light will go off.

- Timer is not available on Dough menus (except menu 28).

### [Simple way to make brioche] Add butter with other ingredients at the beginning.

- Cut the butter into 2 cm cubes and place them into the bread pan at the same time as the other ingredients.
- Follow the steps shown on the left. However, when the machine beeps on step 3 to add extra butter, please leave as it is.
- Time required for completion is 1 hr 50 minutes.

\*When butter is added at the beginning, flavour, texture and rising of bread are a little different from the time bread is baked with extra butter added in later.

- A 'Rest' process will begin immediately after starting, followed by 'Knead' and 'Rise'.
- When adding extra ingredients such as raisins, add them with the butter. (Use max. 150 g for ingredients)
- Even without pressing the Start pad, kneading will continue after 5 min. It does not continue kneading immediately, even if the Start pad is pressed after adding butter or ingredients.
- Do not add butter after display shows remaining time. (P. 49)

- Shape the finished dough and allow it to rise for the second time according to the recipe, then bake in the oven.

# Making Savoury Dough

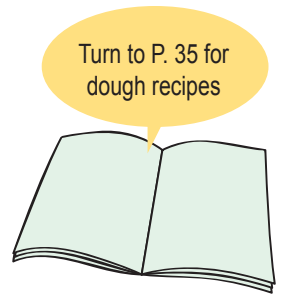

■ To cancel/stop once started (hold for more than 1 second)

Preparations (P. 12)

- ① Set the kneading blade into the bread pan.
- ② Place the ingredients in the bread pan in the order listed in the recipe.
- ③ Set the bread pan into the main unit, and plug the machine into the socket.

## 1 Select menu '21'



## 2 Start the machine



Time until adding the extra ingredients  
\*The above is for high-temperature case.  
'58' is displayed in low-temperature case.

- The start light will come on.

## 3 Add additional ingredients when the beep sounds, then press 'Start' again

Complete placing the extra ingredients while '👏' is flashing. Even without add extra ingredients and pressing the Start pad, 'Knead' and 'Bake' starts automatically after 5 min.

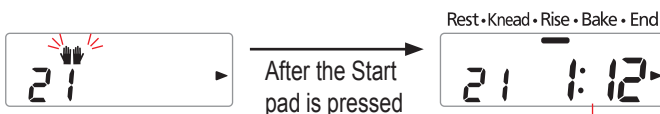

Display indicates remaining time until completion of the programme  
\*The above is for high-temperature case.  
Remaining time is changed depending on the room temperature.  
Low-temperature: 1:20–1:22  
High-temperature: 1:10–1:12

## 4 Press 'Stop' and remove dough

when machine beeps 8 times and the bar at 'End' flashes

- The flashing start light will go off.

- Timer is not available on Dough menus (except menu 28).

- For ingredients, use max. 100 g as size-M, 125 g as size-L or 150 g as size-XL.
- Even without pressing the Start pad, kneading will continue after 5 min. It does not continue kneading immediately, even if the Start pad is pressed after adding ingredients.
- Do not add ingredients after display shows remaining time. (P. 49)
- See P. 17 for Add automatically and manually extra ingredients list.

- Shape the finished dough and allow it to rise for the second time according to the recipe, then bake in the oven.

# Baking Rustic Scone



Turn to P. 32 for bread recipes



■ To cancel/stop once started (hold for more than 1 second)

1

2, 4, 6 7

Preparations  
(P. 12)

- ① Set the kneading blade into the bread pan.
- ② Place the ingredients in the bread pan in the following order: mixture of eggs and milk → yoghurt → other ingredients.
- ③ Set the bread pan into the main unit, and plug the machine into the socket.

## 1 Select menu '17'



## 2 Start the machine

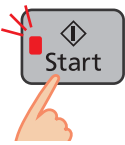

- After 3 minutes



## 3 Open the lid and scrape off the flour within 3 minutes when the beep sounds

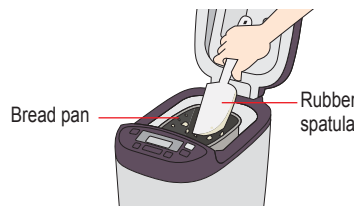

## 4 Press 'Start' again



- Do not press 'Stop'.
- After 1 minute



- The Rustic Scone is different from a loaf using dry yeast.
- Timer is not available on menu 17. (The Timer pad only sets the duration of the baking time.)
- You can mix your favourite ingredients (Nuts, Raisin, Chocolate chips, etc) and place them into the bread pan at the same time as the other ingredients. (Use max. 150 g for ingredients.)
- Use the rubber spatula to avoid damaging the bread pan with non-stick finish. Do not use the metal spatula.
- After 3 minutes have passed in step 3, the beeps sound and 'Knead' starts automatically.



## 5 Open the lid and scrape off the dough, shape the surface of the dough within 3 minutes, when the beep sounds

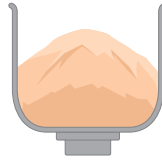

## 6 Press 'Start' again

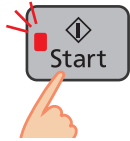

Estimated time until the selected programme is complete  
 Display indicates remaining time until completion of the programme  
 Remaining time: 1:11–1:05

- Do not press 'Stop'.
- The start light will come on.



## 7 Press 'Stop' when the machine beeps and the bar at 'End' flashes, check that baking is complete, and remove the bread pan

- The flashing start light will go off.
- If baking is not complete → Do the following ①–③  
 (Additional cooking time can be made up to twice. Each time should be within 20 minutes. The timer will start again from 1 minute when the unit is hot. Increase the time by pressing the timer pad as required.)

- After 3 minutes have passed in step 5, the beeps sound and 'Bake' starts automatically. (The surface of the rustic scone became uneven, because you did not shape the surface of the dough.)

- If you shake well and remove the rustic scone from the bread pan, the rustic scone will be lose shape.

Be careful!  
It's hot!

- To check whether baking is complete, insert a skewer into the centre of the rustic scone – it is ready if there is no mixture stuck to the skewer when you remove it.

### ① Select menu '17'



### ② Set the baking time



- Can be set up to 1–20 minutes.

### ③ Start the machine



# Baking Cake

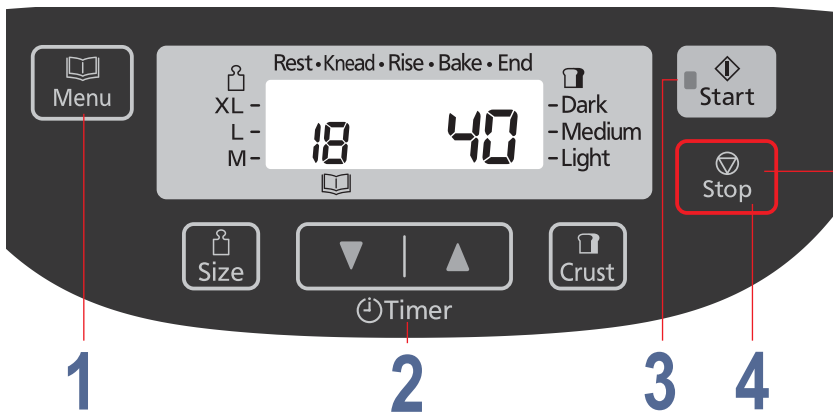

## Preparations

- ① Prepare the ingredients according to the recipe.
- ② Line the bread pan with greaseproof paper and pour in the mixed ingredients.
- ③ Set the bread pan into the main unit, and plug the machine into the socket.

## 1 Select menu '18'

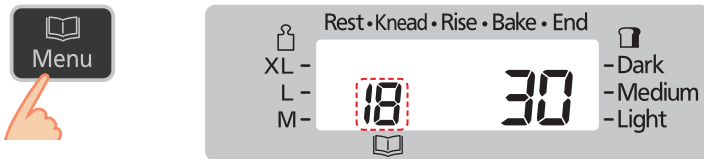

## 2 Set the baking time

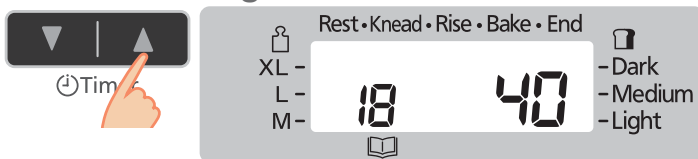

## 3 Start the machine

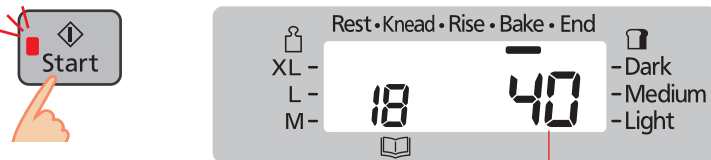

Estimated time until the selected programme is complete

- The start light will come on.

## 4 Press 'Stop' when the machine beeps and the bar at 'End' flashes, check that baking is complete, and remove the bread pan

- The flashing start light will go off.
- If baking is not complete → Repeat steps 1–3 (Additional cooking time can be made up to twice. Each time should be within 50 minutes. The timer will start again from 1 minute when the unit is hot. Increase the time by pressing the timer pad as required.)

Turn to P. 43 for cake recipe

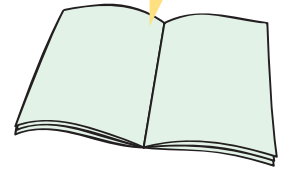

- To cancel/stop once started (hold for more than 1 second)

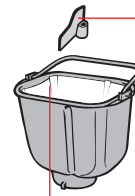

- Remove the kneading blade

- Line with greaseproof paper. (Cake or tea bread will burn if directly touches the bread pan.)

- Timer is not available on menu 18. (The Timer pad only sets the duration of the baking time.)

Be careful!  
It's hot!

- To check whether baking is complete, insert a skewer into the centre of the cake or tea bread – it is ready if there is no mixture stuck to the skewer when you remove it.

# Making Jam

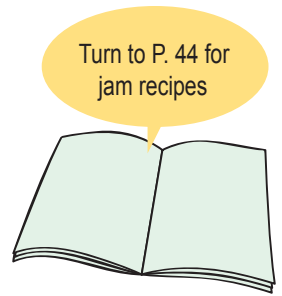

■ To cancel/stop once started (hold for more than 1 second)

## Preparations

- ① Prepare the ingredients according to the recipe.
- ② Put the kneading blade into the bread pan.
- ③ Place the ingredients into the bread pan in the following order:  
half of the fruits → half of the sugar → remainder of fruits → remainder of sugar.
- ④ Set the bread pan into the main unit, and plug the machine into the socket.

## 1 Select menu '32'

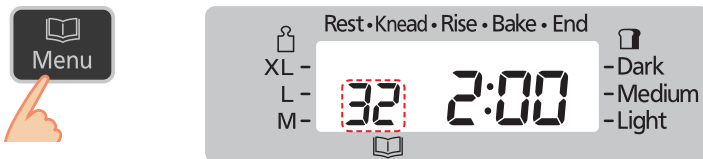

## 2 Set the cooking time

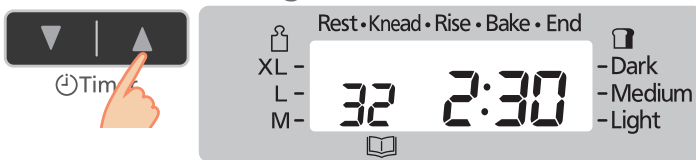

## 3 Start the machine

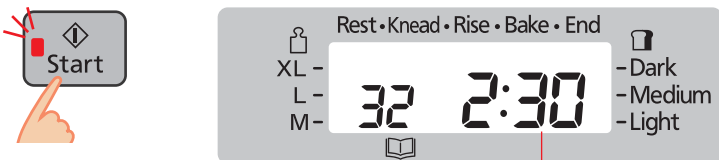

Estimated time until the selected programme is complete

- The start light will come on.

## 4 Press 'Stop' and remove jam

when machine beeps 8 times and the bar at 'End' flashes

- The flashing start light will go off.
- If the cooking is not complete → Repeat steps 1–3  
(Additional cooking time can be made up to twice. Each time should be within 10–40 minutes. The timer will start again from 1 minute when the unit is hot. Increase the time by pressing the timer pad as required.)

- Timer is not available on menu 32.  
(The Timer pad only sets the duration of the cooking time.)
- It is necessary to have an adequate amount of sugar, acid, and pectin to make firm set jam.
- Depending on the type of pectin, it may be better to increase or decrease the amount of it.
- Fruits with a high level of pectin set easily. Fruits with less pectin do not set well.
- Use freshly ripened fruits. Over or under ripe fruits do not set firmly.
- The recipes in this book make soft set jams. This is due to lower levels of sugar.
- Follow the recipe for the quantity for each ingredient.
  - Do not increase or decrease the quantities of fruits. It may cause the jam to boil over or scorch.
  - Do not increase the quantity of sugar more than half quantities of fruits. It may cause the jam to boil over or scorch.
- When decrease the quantity of sugar, jam does not set firm.
  - \*When the acidity of the fruit is strong, you can decrease quantity of the lemon juice but if it is decreased too much, jam does not set firm.
- When the cooking time is short, fruit bits can remain partially and the jam may become watery.
  - The jam will continue to set as it cools. Be careful not to over cook.
- Put the finished jam into the container as soon as possible. Please take care of the burn when you take out jam.
- Jam can burn if it is left in the bread pan.
- Store the jam in a cool, dark place. Due to the lower levels of sugar the shelf life is not as long as shop bought varieties. Once open, refrigerate and consume shortly after opening.

# Making Compote



Turn to P. 44 for compote recipes

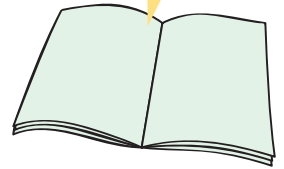

■ To cancel/stop once started (hold for more than 1 second)

- Preparations
- ① Prepare the ingredients according to the recipe. (Remove the kneading blade.)
  - ② Place the ingredients into the bread pan in the following order:  
fruits → sugar → liquid.
  - ③ Set the bread pan into the main unit, and plug the machine into the socket.

## 1 Select menu '33'



## 2 Set the cooking time



## 3 Start the machine



Estimated time until the selected programme is complete

- The start light will come on.



## 4 Press 'Stop' and remove compote

when machine beeps 8 times and the bar at 'End' flashes

- The flashing start light will go off.
- If the cooking is not complete → Repeat steps 1–3  
(Additional cooking time can be made up to twice. Each time should be within 10–40 minutes. The timer will start again from 1 minute when the unit is hot. Increase the time by pressing the timer pad as required.)

- Timer is not available on menu 33.  
(The Timer pad only sets the duration of the cooking time.)
- Follow the recipe for the quantities for each ingredient.
  - Do not increase or decrease the quantities of fruits. It may cause the compote to boil over or scorch.

# Bread Recipes



[1 Basic]  
[2 Basic Rapid]  
[3 Basic Raisin]  
(bread or brown flour)

: Timer can be used for recipes with this symbol (4–13 hours)

Turn to P. 35–42 for dough recipes

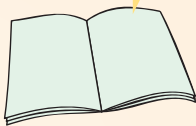

- To raise bread, use strong high protein flour (Bread flour or Bakers flour).
- Bread improver contain Vitamin C, and there is an effect to improve volume of bread. Please add it at the time of the recipe which using a lot of whole wheat flour.
- 100% whole wheat bread is not recommended because it does not rise well.
- When using ORGRAN for gluten free bread, upper side comes to dent easily.
- When using ORGRAN for gluten free bread, always use chilled water.

## White Loaf

Menu '1' (4hr)

	M	L	XL
Bread flour	420 g	520 g	620 g
Salt	1 tsp	2 tsp	2 tsp
Powdered milk	2 tsp	1½ tbsp	1¾ tbsp
Sugar	1 tbsp	1 tbsp	1½ tbsp
Butter	15 g	20 g	25 g
Water	290 mL	360 mL	420 mL
Dry yeast	1¼ tsp	1½ tsp	1½ tsp

## Rapid White Loaf

Menu '2' (1hr 55min–2hr)

	M	L	XL
Bread flour	420 g	520 g	620 g
Salt	1½ tsp	2 tsp	2 tsp
Powdered milk	1 tbsp	1½ tbsp	2 tbsp
Sugar	1 tbsp	2 tbsp	2 tbsp
Butter	15 g	20 g	25 g
Water	290 mL	360 mL	430 mL
Dry yeast	1½ tsp	2¼ tsp	2¼ tsp

## Garlic Herb Bread

Menu '1' (4hr)

	M	L	XL
Bread flour	420 g	520 g	620 g
Salt	1 tsp	2 tsp	2 tsp
Powdered milk	2 tsp	1½ tbsp	1¾ tbsp
Sugar	1 tbsp	1 tbsp	1½ tbsp
Butter	15 g	20 g	25 g
Crushed garlic	1 tsp	2 tsp	2 tsp
Fresh herbs, chopped	2 tbsp	3 tbsp	3 tbsp
Water	290 mL	360 mL	420 mL
Dry yeast	1¼ tsp	1½ tsp	1½ tsp

## Kumara Bread

Menu '1' (4hr)

	M	L	XL
Bread flour	420 g	520 g	620 g
Salt	1 tsp	2 tsp	2 tsp
Powdered milk	2 tsp	1½ tbsp	1¾ tbsp
Butter	15 g	20 g	25 g
Mashed kumara	½ cup	½ cup	¾ cup
Honey	1 tbsp	1 tbsp	1 tbsp
Cinnamon	½ tsp	1 tsp	2 tsp
Water	290 mL	340 mL	390 mL
Dry yeast	1¼ tsp	1½ tsp	1½ tsp

## Cheese & Mustard Loaf

Menu '1' (4hr)

	M	L	XL
Bread flour	420 g	520 g	620 g
Salt	1 tsp	2 tsp	2 tsp
Powdered milk	2 tsp	1½ tbsp	1¾ tbsp
Sugar	1 tbsp	1 tbsp	1½ tbsp
Butter	15 g	20 g	25 g
Mustard powder	1 tsp	2 tsp	3 tsp
Cracked pepper	½ tsp	1 tsp	2 tsp
Cheese	¼ cup	½ cup	¾ cup
Worcestershire sauce	1 tbsp	2 tbsp	3 tbsp
Water	280 mL	310 mL	370 mL
Dry yeast	1¼ tsp	1½ tsp	1½ tsp

## Mexican Chilli Loaf

Menu '1' (4hr)

	M	L	XL
Bread flour	420 g	520 g	620 g
Salt	1 tsp	2 tsp	2 tsp
Powdered milk	2 tsp	1½ tbsp	1¾ tbsp
Sugar	1 tbsp	1 tbsp	1½ tbsp
Butter	15 g	20 g	25 g
Chilli powder	¼ tsp	½ tsp	1 tsp
Tomato paste	2 tsp	1 tbsp	2 tbsp
Corn, cooked	2 tbsp	¼ cup	½ cup
Cumin	½ tsp	1 tsp	2 tsp
Oregano	½ tsp	1 tsp	2 tsp
Water	280 mL	330 mL	380 mL
Dry yeast	1¼ tsp	1½ tsp	1½ tsp

## Curry & Onion Loaf

Menu '1' (4hr)

	M	L	XL
Bread flour	420 g	520 g	620 g
Salt	1 tsp	2 tsp	2 tsp
Powdered milk	2 tsp	1½ tbsp	1¾ tbsp
Sugar	1 tbsp	1 tbsp	1½ tbsp
Butter	15 g	20 g	25 g
Curry powder	2 tsp	1 tbsp	2 tbsp
Onion flakes	2 tsp	1 tbsp	1½ tbsp
Water	290 mL	360 mL	420 mL
Dry yeast	1¼ tsp	1½ tsp	1½ tsp

## Rosemary & Pinenuts Loaf

Menu '3' (4hr)

	M	L	XL
Bread flour	420 g	520 g	620 g
Salt	1 tsp	2 tsp	2 tsp
Powdered milk	2 tsp	1½ tbsp	1¾ tbsp
Sugar	1 tbsp	1 tbsp	1½ tbsp
Butter	15 g	20 g	25 g
Rosemary	1 tbsp	2 tbsp	3 tbsp
Water	290 mL	360 mL	420 mL
Dry yeast	1¼ tsp	1½ tsp	1½ tsp
* Pinenuts	2 tbsp	3 tbsp	4 tbsp

• For addition of ingredients with\*, see the instructions on P. 14.

# Bread Recipes

## Banana Cinnamon Loaf

Menu '3' (4hr) ⌚

	M	L	XL
Bread flour	420 g	520 g	620 g
Salt	1 tsp	2 tsp	2 tsp
Powdered milk	2 tsp	1½ tbsp	1¼ tbsp
Butter	15 g	20 g	25 g
Cinnamon	½ tsp	1 tsp	2 tsp
Honey	2 tsp	1 tbsp	1½ tbsp
Water	290 mL	360 mL	420 mL
Dry yeast	1¼ tsp	1½ tsp	1½ tsp
* Banana chips, chopped	2 tbsp	¼ cup	½ cup

## Chocolate Nut Bread

Menu '3' (4hr) ⌚

	M	L	XL
Bread flour	420 g	520 g	620 g
Salt	1 tsp	2 tsp	2 tsp
Powdered milk	2 tsp	1½ tbsp	1¼ tbsp
Choc bits	2 tbsp	¼ cup	½ cup
Cocoa	½ tsp	1 tsp	2 tsp
Water	300 mL	360 mL	430 mL
Dry yeast	1¼ tsp	1½ tsp	1½ tsp
* Mixed chopped nuts	2 tbsp	¼ cup	½ cup

## [4 Savoury]

(bread flour)

⌚ : Timer can be used for recipes with this symbol (4–13 hours)

## Bacon & Cheese

Menu '4' (4hr) ⌚

	M	L	XL
Bread flour	420 g	520 g	600 g
Salt	1 tsp	2 tsp	2 tsp
Powdered milk	2 tsp	1½ tbsp	1¼ tbsp
Sugar	1 tbsp	1 tbsp	1½ tbsp
Butter	15 g	20 g	25 g
Water	290 mL	360 mL	410 mL
Dry yeast	1¼ tsp	1½ tsp	1½ tsp
* Bacon, cooked	50 g	65 g	75 g
* Cheese, 1 cm	50 g	60 g	75 g

## Mix Olive

Menu '4' (4hr) ⌚

	M	L	XL
Bread flour	420 g	520 g	600 g
Salt	1 tsp	2 tsp	2 tsp
Powdered milk	2 tsp	1½ tbsp	1¼ tbsp
Sugar	1 tbsp	1 tbsp	1½ tbsp
Butter	15 g	20 g	25 g
Water	290 mL	360 mL	410 mL
Dry yeast	1¼ tsp	1½ tsp	1½ tsp
* Mix olive	100 g	125 g	150 g

## Dried Tomato, Cheese & Tomato Juice

Menu '4' (4hr) ⌚

	M	L	XL
Bread flour	420 g	520 g	600 g
Salt	1 tsp	2 tsp	2 tsp
Powdered milk	2 tsp	1½ tbsp	1¼ tbsp
Sugar	1 tbsp	1 tbsp	1½ tbsp
Butter	15 g	20 g	25 g
Water	145 mL	180 mL	200 mL
Tomato juice	145 mL	180 mL	210 mL
Dry yeast	1¼ tsp	1½ tsp	1½ tsp
* Dried tomatoes	30 g	40 g	50 g
* Cheese, cut into 1 cm cubes	70 g	85 g	100 g

## [5 Whole wheat]

## [6 Whole wheat

## Rapid]

## [7 Whole wheat

## Raisin]

(wholemeal flour)

⌚ : Timer can be used for recipes with this symbol (5–13 hours)

## Wholemeal Loaf 75%

Menu '5' (5hr) ⌚

	M	L	XL
Whole wheat flour	300 g	370 g	450 g
Bread flour	100 g	125 g	150 g
Salt	1 tsp	2 tsp	2 tsp
Powdered milk	2 tsp	1½ tbsp	1¼ tbsp
Sugar	1 tbsp	1 tbsp	1½ tbsp
Butter	15 g	20 g	25 g
Water	300 mL	360 mL	420 mL
Bread improver, optional	¼ tsp	½ tsp	½ tsp
Dry yeast	1¼ tsp	1½ tsp	1½ tsp

## Wholemeal Loaf 50%

Menu '5' (5hr) ⌚

	M	L	XL
Whole wheat flour	200 g	250 g	300 g
Bread flour	200 g	250 g	300 g
Salt	1 tsp	2 tsp	2 tsp
Powdered milk	2 tsp	1½ tbsp	1¼ tbsp
Sugar	1 tbsp	1 tbsp	1½ tbsp
Butter	15 g	20 g	25 g
Water	300 mL	360 mL	420 mL
Bread improver, optional	¼ tsp	½ tsp	½ tsp
Dry yeast	1¼ tsp	1½ tsp	1½ tsp

## Rapid Wholemeal Loaf 75%

Menu '6' (3hr) ⌚

	M	L	XL
Whole wheat flour	300 g	370 g	450 g
Bread flour	100 g	125 g	150 g
Salt	1½ tsp	2 tsp	2 tsp
Powdered milk	1 tbsp	1 tbsp	1½ tbsp
Sugar	½ tbsp	1 tbsp	2 tbsp
Butter	15 g	20 g	25 g
Water	300 mL	350 mL	420 mL
Bread improver, optional	¼ tsp	½ tsp	½ tsp
Dry yeast	1½ tsp	2 tsp	2¼ tsp

## Rosemary & Thyme Loaf

Menu '5' (5hr) ⌚

	M	L	XL
Whole wheat flour	300 g	370 g	450 g
Bread flour	100 g	125 g	150 g
Salt	1 tsp	2 tsp	2 tsp
Powdered milk	2 tsp	1½ tbsp	1¼ tbsp
Sugar	1 tbsp	1 tbsp	1½ tbsp
Butter	15 g	20 g	25 g
Rosemary	1 tbsp	2 tbsp	3 tbsp
Thyme	1 tbsp	2 tbsp	3 tbsp
Water	300 mL	360 mL	420 mL
Bread improver, optional	¼ tsp	½ tsp	½ tsp
Dry yeast	1¼ tsp	1½ tsp	1¼ tsp

• For addition of ingredients with \*, see the instructions on P. 14.

### Sesame & Bran Loaf

Menu '5' (5hr) ⌚

	M	L	XL
Whole wheat flour	300 g	370 g	450 g
Bread flour	100 g	125 g	150 g
Salt	1 tsp	2 tsp	2 tsp
Powdered milk	2 tsp	1½ tbsp	1¼ tbsp
Sugar	1 tbsp	1 tbsp	1½ tbsp
Butter	15 g	20 g	25 g
Unprocessed bran	2 tbsp	¼ cup	½ cup
Sesame seeds	2 tsp	1 tbsp	2 tbsp
Golden syrup	2 tsp	1 tbsp	1½ tbsp
Water	300 mL	360 mL	420 mL
Bread improver, optional	¼ tsp	½ tsp	½ tsp
Dry yeast	1¼ tsp	1½ tsp	1¾ tsp

### Date & Nut Loaf

Menu '7' (5hr) ⌚

	M	L	XL
Whole wheat flour	300 g	370 g	450 g
Bread flour	100 g	125 g	150 g
Salt	1 tsp	2 tsp	2 tsp
Powdered milk	2 tsp	1½ tbsp	1¼ tbsp
Butter	15 g	20 g	25 g
Chopped dates	¼ cup	½ cup	½ cup
Water	300 mL	360 mL	420 mL
Bread improver, optional	¼ tsp	½ tsp	½ tsp
Dry yeast	1¼ tsp	1½ tsp	1¾ tsp
* Chopped walnuts	¼ cup	½ cup	½ cup

### Rye 100%

Menu '8' (3hr 30min) ⌚

Rye flour	500 g
Sugar	2 tsp
Oil	3 tbsp
Salt	2 tsp
Water	380 mL
Dry yeast	3 tsp

### French Bread

Menu '9' (6hr) ⌚

Bread flour	420 g
Salt	1½ tsp
Butter	5 g
Water	310 mL
Dry yeast	1¼ tsp

### Orange Poppyseed Loaf

Menu '5' (5hr) ⌚

	M	L	XL
Whole wheat flour	300 g	370 g	450 g
Bread flour	100 g	125 g	150 g
Salt	1 tsp	2 tsp	2 tsp
Powdered milk	2 tsp	1½ tbsp	1¼ tbsp
Sugar	1 tbsp	1 tbsp	1½ tbsp
Butter	15 g	20 g	25 g
Orange rind	1 tbsp	2 tbsp	3 tbsp
Poppy seeds	2 tbsp	¼ cup	½ cup
Water	300 mL	360 mL	420 mL
Bread improver, optional	¼ tsp	½ tsp	½ tsp
Dry yeast	1¼ tsp	1½ tsp	1¾ tsp

### Mixed Grain Bread

Menu '7' (5hr) ⌚

	M	L	XL
Whole wheat flour	80 g	100 g	150 g
Bread flour	250 g	300 g	350 g
Oatmeal	40 g	50 g	50 g
Buckwheat groats	40 g	50 g	50 g
Cornmeal	20 g	30 g	30 g
Whole linseed	2 tsp	1 tbsp	1½ tbsp
Brown sugar	1 tbsp	1 tbsp	1½ tbsp
Butter	20 g	25 g	25 g
Powdered milk	1½ tbsp	2 tbsp	2 tbsp
Salt	1 tsp	2 tsp	2 tsp
Water	300 mL	370 mL	450 mL
Dry yeast	1¼ tsp	1½ tsp	1¾ tsp
* Toasted sunflower seed	2 tsp	1 tbsp	1½ tbsp

### Rye and Wholemeal

Menu '8' (3hr 30min) ⌚

Rye flour	250 g
Whole wheat flour	250 g
Sugar	2 tsp
Oil	2 tbsp
Salt	2 tsp
Water	380 mL
Dry yeast	2½ tsp

### Tarragon & Thyme

Menu '9' (6hr) ⌚

Bread flour	420 g
Salt	1½ tsp
Butter	5 g
Tarragon	1 tbsp
Thyme	1 tbsp
Water	310 mL
Dry yeast	1¼ tsp

### [8 Rye]

(rye flour)

- Remember to use the rye kneading blade for all these recipes.
- The Raisin nut dispenser does not operate on the Rye programme.
- Put any additional ingredients directly into the bread pan at the start.
- As a result of the consistency some flour may remain on the sides of the loaf, but this is normal.
- Due to their consistency, the kneading blade will often become embedded in Rye Bread loaves. Wait for the loaf to cool (to avoid burning your hands), before removing the blade by pressing on the base of the loaf and manipulating it out gently to avoid damaging the loaf.

⌚: Timer can be used for recipes with this symbol (3 hours 30 minutes–13 hours)

### [9 French]

(bread flour/wholemeal flour)

Make bread with a crispy crust and texture.

⌚: Timer can be used for recipes with this symbol (6–13 hours)

\* For addition of ingredients with\*, see the instructions on P. 14.

# Bread Recipes

## [10 Rustic Sourdough]

: Timer can be used for recipes with this symbol (5–9 hours)

### Rustic Sourdough

Stage 1 Sourdough starter: Menu '27' (24hr)   
Turn to P. 18 and P. 42 for the sourdough starter recipe.

Stage 2: Menu '10' (5hr)

Bread flour	400 g
Salt	1 tsp
Water	150 mL
Dry yeast	¾ tsp

## [11 Italian]

(bread flour)

Make light bread for enjoying with pasta, etc.

- The Raisin nut dispenser does not operate on the Italian programme.
- Put any additional ingredients directly into the bread pan at the start.

: Timer can be used for recipes with this symbol (4 hours 30 minutes–13 hours)

### Italian Bread

Menu '11' (4hr 30min)

Bread flour	400 g
Salt	1½ tsp
Olive oil	1 tbsp
Water	260 mL
Dry yeast	1 tsp

### Herb Bread

Menu '11' (4hr 30min)

Bread flour	400 g
Salt	1½ tsp
Olive oil	1 tbsp
Basil	1 tbsp
Water	260 mL
Dry yeast	1 tsp

### Sundried Tomato and Parmesan

Menu '11' (4hr 30min)

Bread flour	400 g
Sugar	1 tsp
Salt	½ tsp
Parmesan Cheese, grated	50 g
Sundried Tomatoes in oil, chopped	75 g
Water	270 mL
Dry yeast	1 tsp

## [12 Sandwich]

Make bread with a soft crust and texture.

: Timer can be used for recipes with this symbol (5–13 hours)

### Basic Sandwich Bread

Menu '12' (5hr)

Bread flour	420 g
Salt	1¼ tsp
Powdered milk	2 tsp
Sugar	2½ tsp
Butter	15 g
Water	315 mL
Dry yeast	1¼ tsp

### Whole Wheat Sandwich Bread

Menu '12' (5hr)

Whole wheat flour	320 g
Bread flour	100 g
Salt	1¼ tsp
Powdered milk	2 tsp
Sugar	2½ tsp
Butter	15 g
Water	315 mL
Bread improver, optional	¼ tsp
Dry yeast	1¼ tsp

## [13 Brioche]

### Basic Brioche

Menu '13' (3hr 30min)

Bread flour	400 g
Salt	1 tsp
Sugar	3 tbsp
Butter (Cut into 2 cm cubes and keep in refrigerator)	50 g
Powdered milk	2 tbsp
Eggs (Medium)	2 (100 g)
Water	180 mL
Dry yeast	1½ tsp
* Butter for added later (Cut into 1–2 cm cubes and keep in refrigerator)	70 g

### Pannettone

Menu '13' (3hr 30min)

Bread flour	400 g
Sugar	4 tbsp
Salt	1 tsp
Butter (Cut into 2 cm cubes and keep in refrigerator)	50 g
Egg medium (beaten)	2 (100 g)
Milk	200 mL
Dry yeast	1¼ tsp
* Additional Butter (Cut into 1–2 cm cubes and keep in refrigerator)	70 g
* Orange Peel; Chopped Finely	50 g
* Brown Saltana	50 g
* Dried Black Currant	50 g

## [15 Speciality]

## [16 Speciality Raisin]

: Timer can be used for recipes with this symbol (4 hours 30 minutes–13 hours)

### Spelt White Bread

Menu '15' (4hr 30min)

	M	L	XL
Spelt white flour	400 g	500 g	600 g
Salt	1¼ tsp	1½ tsp	1¾ tsp
Sugar	1½ tsp	2 tsp	2 tsp
Butter	10 g	20 g	25 g
Water	250 mL	310 mL	360 mL
Dry yeast	1¼ tsp	1½ tsp	1¾ tsp

### Rye and Spelt

Menu '15' (4hr 30min)

	M	L	XL
Spelt white flour	275 g	350 g	425 g
Rye flour	125 g	150 g	175 g
Salt	1¼ tsp	1½ tsp	1¾ tsp
Sugar	1½ tsp	2 tsp	2 tsp
Butter	5 g	10 g	10 g
Plain yoghurt	120 g	150 g	180 g
Water	140 mL	180 mL	200 mL
Dry yeast	1¼ tsp	1½ tsp	1¾ tsp

## [17 Rustic Scone]

### Rustic Scone

Menu '17' (1hr 15min)

Bread flour	360 g
Butter (Cut into 1 cm cubes)	60 g
Egg	2
Milk	160 g (mixture of eggs and milk)
Yoghurt	60 g
Salt	½ tsp
Sugar	40 g
Baking powder	10 g

• For addition of ingredients with\*, see the instructions on P. 14.



# Gluten Free Recipes

## [2 Basic Rapid] [14 Gluten Free]

(gluten free bread mix / wheat free bread mix)

⊗: Timer cannot be used

- The raisin nut dispenser does not operate on the Gluten Free programme.
- Put any additional ingredients directly into the bread pan at the start.
- You can bake gluten free cakes following our recipes on P. 43 by substituting gluten free plain flour for standard plain flour. If self-raising flour is required also add 1 tsp of gluten free baking powder.
- You can purchase gluten free bread mix at:
  - Pharmacies
  - Health food shops
  - Major supermarkets

### Note

- Making gluten free bread is very different from the normal way of producing bread in the bread maker. Please read through the guidelines on the right.
- Please consult flour manufacturers for detailed information.
- As a result of consistency some flour may remain on the sides of the loaf, but this is normal.

## Before making gluten free bread

### ■ Consult your doctor and follow the guidelines below!

If you make gluten free bread as part of dietary therapy, it is important that you avoid cross-contamination with flour that does contain gluten. Please take particular care when washing the bread pan and the kneading blade, etc.

### ■ It is made differently to other types of bread!

#### The order of putting in ingredients is different

Please put in the ingredients in the following order so that the gluten free bread mix is well mixed. (The wrong order may result in poor rising)

→ Water, salt, fat → gluten free bread mix → dry yeast

#### The outcome differs depending on the type of flour

The recipes below have been developed with particular types of bread mix, and so the final outcome may differ depending on the actual bread mix used. (There may be greater variation with wheat free bread mixes.)

#### If kneading blade becomes embedded in bread

Due to their consistency, the kneading blade will often become embedded in Gluten and Wheat Free Bread loaves. Wait for the loaf to cool (to avoid burning your hands), before removing the blade by pressing on the base of the loaf and manipulating it out gently to avoid damaging the loaf.

#### Consume within two days

Store your finished bread in a cool, dry place, and consume within two days. If you cannot finish it all in time, cut it into pieces, place in a freezer bag and into the freezer.

### Wheat and gluten free bread

Menu '14' (1hr 50min) ⊗

Water (chilled)	450 mL
Vegetable oil	3 tbsp
ORGRAN Easy Bake bread mix	450 g

For more information on ORGRAN's gluten free bread mixes, please contact the address below:



Division of Roma Food Products, 47-53 Aster Avenue, Carrum Downs, Victoria 3201

# Gluten Free Recipes

## Gluten free bread on Basic programme Menu '2'-'XL' Size-'Dark' Crust (2hr)

### Yeasted plain gluten free loaf

Water	430–450 mL
Oil (Canola/Sunflower)	½ cup
Egg (Medium)	3
White vinegar (not malt)	1 tsp
Brown rice flour	1 cup
White rice flour	1 cup
Arrowroot or tapioca flour	1 cup
Besan (chick pea) flour or soya flour	½ cup
White or brown rice flour	½ cup
Salt	1–1½ tsp
Sugar	2 tbsp
Xantan gum	1 tbsp
Dry yeast (not rapid rise)	2 tsp

### Yeasted fruit gluten free loaf

Yeasted plain gluten free loaf (above)	one batch
Brown sugar	3 tbsp
Cinnamon	1 tsp
Dried fruit	1 cup

### Yeasted cheese gluten free loaf

Yeasted plain gluten free loaf (above)	one batch
Grated cheese	1 cup

### Yeasted seeded gluten free loaf

Yeasted plain gluten free loaf (above)	one batch * Water 450–480 mL
Seed mixture	3 tbsp

### Important Notes:

1. Do not leave gluten free bread in for keep warm. Remove bread from Machine when baking is complete.
2. Always assist kneading 5–10 minutes into kneading process. Lift lid (do not turn machine off), with spatula mix to ensure all wet and dry ingredients are combined, scrape down sides. Test dough by lifting some on spatula. Dough should fall slowly from spatula. If too thin add 2–4 tbsp of rice flour. If too thick, add 1–3 tbsp of water. (It should look like a thick cake mix or stiff mashed potato).
3. 3 tbsp powdered milk can be added to any of these recipes. Yeast responds to protein by adding cheese and/or powdered milk, therefore the loaf will rise more.
4. Flour fluctuates in refining therefore water content differs considerably. Very refined flour (e.g. rice flour labeled rice starch) will not need as much water as a more course flour (e.g. McKenzies). You may need to cut water back 20–30 mL for finer flour.

# Dough Recipes



[19 Basic] [20 Basic Raisin] [21 Savoury]  
 [22 Whole wheat] [23 Whole wheat Raisin]  
 [24 Rye] [25 French] [26 Rustic Sourdough]  
 [27 Sourdough starter] [28 Pizza] [29 Brioche]  
 [30 Speciality]

The Dough setting mixes and gives the dough its first rising before you shape and bake it in your conventional oven.

: Timer cannot be used (except pizza)

Prepare your ingredients according to the recipe and select the correct menu. When your dough is ready, shape it, allow it to rise, and then bake it yourself.

- The maximum load of the Bread Maker is 600 g.  
Dough recipes using 300 g of flour may be doubled.
- When the DOUGH programme has completed its operation, you may find that the prepared dough is easier to shape if it is tipped onto a lightly floured board before handling.

## Example – making plain bread rolls

### ① Shaping

Dough can be shaped into round rolls, plaits, knots, French sticks, large or small cobs or put in a traditional loaf tin.

#### ● Rolls

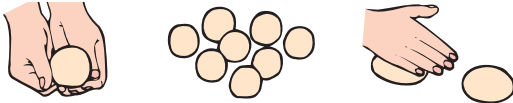

#### ● Knot



#### ● Hedgehogs

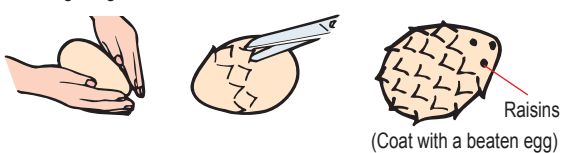

### ② Proving

Most recipes require the dough to be left to prove i.e. to be left to rise after shaping, before the final baking. Generally the dough should be left to prove in a warm place (at approximately 30–35°C) until the dough has doubled in size.

- Approximate proving time-Rolls 30–50 minutes, Whole breads 50 minutes.
- To prevent a hard dry skin forming, cover the dough with a large polythene bag or cover with lightly oiled cling film.

### ③ Glazing/Baking

Brush with milk, salted water, beaten egg or oil. Sprinkle with poppy seeds, sesame seeds. Bake following recipe guidelines.

## Rolls

- Select one of the following recipes and follow the method below.

1 Shape dough.



2 Place onto a greased baking tray and allow to prove until doubled in size.



3 Brush with beaten egg.

4 Bake in a preheated oven at 180–200°C for 10–20 minutes or until golden brown.

## Basic Dough

Menu '19' (2hr 20min)

Bread flour	475 g
Salt	2 tsp
Powdered milk	3 tbsp
Sugar	1¼ tbsp
Butter	45 g
Water	300 mL
Dry yeast	2 tsp

## Savoury Dough

Menu '21' (2hr 20min)

Bread flour	520 g
Salt	2 tsp
Powdered milk	1½ tbsp
Sugar	1 tbsp
Butter	20 g
Water	350 mL
Dry yeast	1½ tsp
* Bacon, cooked	65 g
* Cheese, 1 cm	60 g

## Wholemeal Dough 75%

Menu '22' (3hr 15min)

Whole wheat flour	370 g
Bread flour	125 g
Salt	2 tsp
Powdered milk	1½ tbsp
Sugar	1 tbsp
Butter	20 g
Water	360 mL
Bread improver, optional	½ tsp
Dry yeast	2 tsp

## Rustic Sourdough Dough (Standard)

Stage 1 Sourdough starter: Menu '27' (24hr)

Turn to P. 18 and P. 42 for the sourdough starter recipe.

Stage 2: Menu '26' (2hr 30min)

Bread flour	400 g
Salt	1 tsp
Water	150 mL
Dry yeast	¾ tsp

## Rustic Sourdough Dough (Rye)

Stage 1 Sourdough starter: Menu '27' (24hr)

Turn to P. 18 and P. 42 for the sourdough starter recipe.

Stage 2: Menu '26' (2hr 30min)

Bread flour	360 g
Rye flour	40 g
Salt	1 tsp
Water	150 mL
Dry yeast	¾ tsp

• For addition of ingredients with\*, see the instructions on P. 14.

# Dough Recipes

## Croissants

Menu '19' (2hr 20min) 

Bread flour	475 g
Salt	2 tsp
Powdered milk	3 tbsp
Sugar	¼ cup
Butter	30 g
Water	300 mL
Dry yeast	2 tsp
Butter, chilled for folding in the dough	250 g

### Method:

- 1 Roll 250 g of chilled butter between two sheets of plastic wrap into a rectangle (17 × 25 cm). Chill at least 1 hour.



- 2 Turn the dough into a greased bowl. Place in the refrigerator for 30 minutes.

- 3 Roll out the dough on a lightly floured surface into a 30 cm square.



- 4 Place the rolled out butter over two-thirds of the dough. Fold the third without butter over the centre third.



- 5 Fold the remaining third on top. Seal edges. Rest the dough in the refrigerator for 20–30 minutes.

- 6 Place the dough at right angles to the previous position in the step 4. Roll out into 30 cm square.

Fold into thirds. Wrap and place into refrigerator for 20–30 minutes.

Roll and fold twice more. Wrap and chill after each folding. After the final folding, chill several hours or overnight.



- 7 Spread the dough for the final time into 30 cm square. Cut dough into 9 equal squares. Cut each square diagonally to form two triangles.

- 8 Roll up each triangle loosely, starting from the side opposite the point. Curve ends.



- 9 Place seam side down on a greased baking tray. Cover and place in warm area for 30–50 minutes or until almost doubled in size.



- 10 Brush with beaten egg. Bake in a preheated 200°C oven for 15–20 minutes or until golden brown.

## Doughnuts

- 1 Use Basic Dough recipe on P. 35.

- 2 Divide the dough into equal portions. Roll each portion into a ball.

- 3 Place on a lightly floured surface. Cover with a plastic wrap and leave to rise for 20 minutes.

- 4 Shape each ball as desired, in a ring, twisted, or in an oval shape. Place on a greased tray.

- 5 Leave to rise at 30°C for 30 minutes.

- 6 Deep fry the doughnuts until golden brown.

- 7 Roll in a mixture of sugar and cinnamon or cool and use other toppings as desired.

- 8 Makes 12–16 doughnuts dependent on size and shape selected.

## Hot Cross Buns

Menu '20' (2hr 20min) 

Bread flour	475 g
Salt	2 tsp
Powdered milk	3 tbsp
Sugar	1¼ tbsp
Butter	45 g
Orange rind	1 tbsp
Mixed spruce	1 tbsp
Water	260 mL
Egg, medium	1
Dry yeast	2 tsp
* Mixed Dried fruit	1 cup

### Method:

- 1 Divide the dough into 10 or 12 equal portions. Roll each portion into a ball, and rest for 20 minutes.
- 2 Shape into a smooth ball by gently rolling, and place on a greased tray.
- 3 Cover and leave to rise in a warm place (30–35°C) for 30 minutes or until doubled in size.
- 4 Put the crosses on the dough

#### Crosses

Flour	½ cup
Oil	2 tbsp
Water to mix	

Mix flour and oil, then add water to make a stiff paste. Pipe into the shape of crosses — if a piping bag is not available, use a small plastic bag with a corner cut off.

- 5 Bake in a preheated 200°C oven for 15–25 minutes or until golden brown. Brush with the glaze.

#### Glaze

Milk	3 tbsp
Castor sugar	3 tbsp

Boil together until syrupy — brush over cooked buns when they are removed from the oven.

## Olive & Rosemary Rolls

Menu '20' (2hr 20min) 

Bread flour	450 g
Salt	1 tsp
Powdered milk	2 tbsp
Sugar	1 tsp
Olive oil	1 tbsp
Fresh rosemary, chopped	1 tbsp
Water	260 mL
Dry yeast	2 tsp
* Pitted black olives, quartered	50 g

### Method:

- 1 Turn the dough out into a greased bowl. Cover and let the dough rest for 20 minutes in the refrigerator.
- 2 Divide the dough into 12–16 equal portions or into 2 long loaves and place on a greased baking tray. Cover and leave to rise in a warm place (30–35°C) for 30 minutes or until doubled in size.
- 3 Brush with beaten egg and sprinkle with seeds.
- 4 Bake in a preheated 200°C oven for 15–25 minutes or until golden brown.

# Dough Recipes

## Swedish Tea Ring

Menu '19' (2hr 20min) 

Bread flour	450 g
Salt	1 tsp
Powdered milk	3 tbsp
Sugar	4 tbsp
Butter	50 g
Water	230 mL
Dry yeast	2 tsp

### Method:

#### Filling

Melted butter	2 tsp
Cinnamon	2 tsp
Brown sugar	½ cup

- 1 Roll or pat the dough into a rectangle (50 × 30 cm).
- 2 Brush over surface of the dough with melted butter.
- 3 Mix cinnamon and brown sugar and sprinkle over butter.
- 4 Roll up like a swiss roll starting from the long side.
- 5 Press edges firmly underneath.
- 6 Join ends to make a circle, pinch edges together and place on a greased oven tray.
- 7 Cut nearly through to the centre of the ring at 2.5 cm intervals, turning each section so that it faces cut side up.
- 8 Cover with plastic wrap and leave to rise in a warm place (30–35°C) for 30 minutes.
- 9 Brush with beaten egg.
- 10 Bake in a preheated 180°C oven for 15–25 minutes or until golden brown.
- 11 Other fillings such as dried fruit, jam, mincemeat, nuts etc can be used.
- 12 This tea ring can be iced with a vanilla icing if desired.

## Sundried Tomato & Basil Rolls

Menu '20' (2hr 20min) 

Bread flour	450 g
Salt	1 tsp
Sugar	1 tsp
Olive oil	1 tbsp
Fresh basil, chopped	2 tbsp
Grated parmesan cheese	2 tbsp
Water	250 mL
Dry yeast	2 tsp
* Sundried tomatoes, chopped	¼ cup

### Method:

- 1 Divide the dough into 12 equal portions. Roll each portion into a ball, and rest for 20 minutes.
- 2 Shape into a smooth ball by gently rolling, and place on a greased tray.
- 3 Cover and leave to rise in a warm place (30–35°C) for 30 minutes or until doubled in size.
- 4 Bake in a preheated 200°C oven for 15–20 minutes or until goldenbrown.

• For addition of ingredients with\*, see the instructions on P. 14.

## Bagels

Menu '19' (2hr 20min) 

Bread flour	450 g
Salt	1 tsp
Powdered milk	2 tbsp
Sugar	1 tbsp
Butter or oil	2 tbsp
Water	250 mL
Dry yeast	2 tsp

### Method:

- 1 Divide dough into 12–16 equal portions.
- 2 Roll each portion into a log approximately 20 cm long.
- 3 Form into a ring, sealing both ends together tightly. Place on a lightly greased tray and cover with glad wrap. Leave to rise in a warm place (30–35°C) for 30 minutes.
- 4 Bring a large saucepan of water to the boil. Using a slotted spoon place 3–4 bagels into the water at a time. Boil for 1 minute turning once. Lift out and drain well.
- 5 Brush with the beaten egg and sprinkle over seeds.
- 6 Bake at 200°C for 20–30 minutes.

## Whole Wheat Raisin Rolls

Menu '23' (3hr 15min) 

Bread flour	200 g
Whole wheat flour	200 g
Salt	2 tsp
Powdered milk	1½ tbsp
Sugar	1 tsp
Butter	20 g
Cinnamon	1 tbsp
Water	280 mL
Bread improver, optional	¼ tsp
Dry yeast	1½ tsp
* Raisins	½ cup

### Method:

- 1 Divide the dough into 16 equal portions. Shape each portion into a roll. (Follow instructions on P. 35.)
- 2 Place on a greased baking tray. Cover and let rise in a warm place (30–35°C) for 30–40 minutes until almost doubled in size.
- 3 Brush rolls with beaten egg, garnish with sliced almonds and sugar, if desired.
- 4 Bake in a preheated 190°C oven for 15–20 minutes.

# Dough Recipes

## Sunflower & Kibblewheat Rolls

Menu '22' (3hr 15min) 

Bread flour	225 g
Whole wheat flour	225 g
Salt	1 tsp
Powdered milk	2 tbsp
Sugar	1 tsp
Butter	25 g
Sunflower seeds	¼ cup
Kibbled wheat	¼ cup
Water	300 mL
Bread improver, optional	¼ tsp
Dry yeast	2 tsp

### Method:

- 1 Divide the dough into 12–16 equal portions. Shape into smooth balls and place on a lightly greased baking tray. Cover and leave to rise in a warm place (30–35°C) for 40–60 minutes or until doubled in size.
- 2 Brush the tops with beaten egg, then sprinkle with seeds.
- 3 Bake in a preheated 200°C oven for 20–30 minutes or until golden brown.

## Rye & White Rolls

Stage 1 Culture: Menu '28' (45min) 

Bread flour	75 g
Rye flour	150 g
Water	200 mL
Dry yeast	1 tsp

Stage 2: Menu '24' (2hr) 

Rye flour	150 g
Bread flour	100 g
Sugar	2 tsp
oil	3 tbsp
Salt	2 tsp
Water	60 mL
Dry yeast	1¼ tsp

### Method:

- 1 Put all culture ingredients in the bread pan and select menu 28.
  - Use kneading blade (rye bread).
- 2 Turn off at the stop pad after 15 minutes.  
⋮ (12 hours later)  
↓
- 3 Add all ingredients listed in stage 2 and select menu 24.
- 4 Divide dough into 12–15 pieces and shape into rolls.
- 5 Place on a greased baking tray and sprinkle with flour. Leave to rise in a warm place (30–35°C) for 25–35 minutes or until doubled in size.
- 6 Glaze with oil and bake in a preheated oven at 220°C for 10–15 minutes or until golden brown.



## French Bread

Menu '25' (3hr 35min) 

Bread flour	475 g
Salt	2 tsp
Sugar	2 tsp
Butter	10 g
Water	290 mL
Dry yeast	2 tsp

### Method:

- 1 Let the dough rest in a greased bowl for 20–30 minutes.
- 2 Knead dough on a lightly floured surface until it becomes elastic and springs back when touched.
- 3 Divide the dough into 2 balls. Cover and let rest in a warm place for 20 minutes.
- 4 Shape each ball into a flat rectangle. Roll up tightly from long side; seal well. Taper ends.
- 5 Place on a greased baking tray. With a sharp knife, make 3 or 4 diagonal cuts about ½ cm deep across top of the loaves. Cover and leave to rise in a warm place (30–35°C) for 40–50 minutes until almost doubled in size.
- 6 Brush with beaten egg white, sprinkle with poppy seeds.
- 7 Bake in a preheated 200°C oven for 25–30 minutes or until golden brown.

## Brioche Dough (Chocolate Chip Brioche Roll)

; for 12 rolls

Menu '29' (1hr 50min) 

Bread flour	400 g
Sugar	4 tbsp
Salt	1½ tsp
Butter (Cut into 2 cm cubes and keep in refrigerator)	70 g
Egg (beaten)	3 (150 g)
Milk	90 mL
Rum (Dark)	15 mL (1 tbsp)
Dry yeast	1¼ tsp
* Additional Butter (Cut into 1–2 cm cubes and keep in refrigerator)	50 g

### Optional Ingredients

Chocolate chips	120 g
-----------------	-------

• For addition of ingredients with\*, follow programming instructions on P. 22.

### Method:

- 1 Press the dough lightly to remove the gas.
- 2 Shape it round and wrap it with plastic wrap. Then rest it in the refrigerator for 20 minutes.
  - When you like to add chocolate chips, follow below instructions. (Optional)
    - Roll the dough to 25 × 30 cm (10"×12")
    - Sprinkle chocolate chips and fold the bottom one third up and the top one third down. Then fold it in half.
    - Rest the dough in the room temperature for 10 minutes again. (Do not dry it .)
- 3 Press the dough lightly to remove the gas again, and divide it into 12 rolls.
- 4 Rest the dough in the room temperature for 10–15 minutes. (Do not dry it out.)
- 5 Shape the dough and place them on a greased baking tray and allow to prove at 35°C for 30–40 minutes.
- 6 Glaze and bake in oven at 180°C for 15–20 minutes.

# Dough Recipes

## Spelt Table Roll

; for 8 rolls

Menu '30' (2hr 45min)

Spelt White Flour	500 g
Sugar	1½ tsp
Salt	1½ tsp
Butter	10 g
Water*	280 mL
Dry yeast	2 tsp

\* If in a hot room, use chilled water

### Method:

- 1 Divide dough into 8 rolls and rest them for 15 minutes.
- 2 Shape the dough into rolls.
- 3 Place on a greased baking tray and allow to prove at 35°C until doubled in size. (approx. 40 minutes.)
- 4 Make a cut on top of the dough and bake in oven at 220°C for 15–20 minutes. (coupe)

## Pizza

Menu '28' (45min)

Bread flour	475 g
Salt	1 tsp
Powdered milk	1 tbsp
Sugar	1¼ tbsp
Olive oil	2 tbsp
Water	300 mL
Dry yeast	1 tsp

### Method:

- 1 Knead dough on a lightly floured surface until it becomes elastic and springs back when touched.
- 2 Divide into 6 balls or 2 large balls, and place in warm area for 10 minutes.
- 3 Shape each ball into a flat circle. Place the circles on a baking tray and prick with a fork.
- 4 Leave to rise at room temperature for 15 minutes.
- 5 Brush each circle with tomato paste. Sprinkle with Mozzarella cheese. Top with your favourite topping, such as sliced onions, pepperoni, cooked sausage, capsicum or olives.
- 6 Bake in a preheated 210°C oven for 15–20 minutes.

## Focaccia

Menu '28' (45min)

Bread flour	475 g
Salt	2 tsp
Powdered milk	2 tbsp
Sugar	2 tbsp
Olive oil	2 tbsp
Water	300 mL
Dry yeast	2 tsp

### Method:

- 1 Knead dough on a lightly floured surface until it becomes elastic and springs back when touched.
- 2 Shape into a flat circle, place on a baking tray, make holes with the end of a wooden spoon 5 cm apart over the surface of the dough.
- 3 Cover and leave to rise in a warm place (30–35°C) for 20–30 minutes or until almost doubled in size.
- 4 Brush surface with olive oil, sprinkle with salt, basil, rosemary and thyme.

#### Topping

Olive oil	2 tbsp
Salt	½ tsp
Dried basil	1 tsp
Dried rosemary	1 tsp
Dried thyme	1 tsp

- 5 Bake in a preheated 210°C oven for 26–30 minutes.

# Sourdough Starter Recipe

## Sourdough Starter

Menu '27' (24hr)

The amount for a sourdough cup

Rye flour	80 g
Salt	½ tsp
Yoghurt	60 g
Water (20°C)	80 mL
Dry yeast (use the sourdough starter spoon)	1 (0.1 g)

# Cake Recipes



## [18 Bake only]

Bake cakes and teabreads.

: Timer cannot be used

- Use menu 18 for these recipes.
- This menu is not suitable for all types of cake, such as Victoria sandwich or those that require going into a hot oven.
- Always use our tablespoon and teaspoon measure in these recipes.

The cake is made according to the recipe in a separate mixing bowl and then baked inside the bread pan.

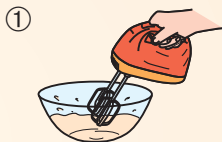

Mix the ingredients in a bowl.



Line the bottom and sides of the bread pan with baking parchment and pour in the mixture.

- Make sure that the kneading blade is removed from the pan before the cake mixture is added.
- Ensure that the cake mixture is kept inside the baking parchment.



Set the bread maker. (P. 26)  
• The maximum baking time is 1 hour 30 minutes.

### Butter Cake

Menu '18' (50min)

Butter	100 g
Sugar	100 g
Egg, medium	2
Plain flour	275 g
Baking powder	2½ tsp
Milk	90 mL
Vanilla essence	1 tsp

### Fruit & Walnut Cake

Menu '18' (50min)

Butter	90 g
Brown Sugar	¾ cup
Egg, medium	2
Whole wheat flour	150 g
Baking powder	½ tsp
Cinnamon	½ tsp
Nutmeg	½ tsp
Milk	⅓ cup
Raisins	½ cup
Sultanas	½ cup
Walnuts chopped	½ cup

### Chocolate Cake

Menu '18' (50min)

Butter	100 g
Sugar	100 g
Egg, medium	2
Plain flour	275 g
Cocoa	30 g
Baking powder	2½ tsp
Milk	90 mL
Vanilla essence	1 tsp

#### Method:

- 1 Sift flour into a bowl.
- 2 Soften butter at room temperature. Add sugar and beat well until creamy.
- 3 Add eggs one by one and beat further until the mixture resembles frothy cream.
- 4 Add flour and baking powder a half portion at a time and mix well.
- 5 Add remaining ingredients.
- 6 Remove the kneading blade from the bread pan and line the bottom and sides with baking parchment. Pour the mixture into the bread pan.
- 7 Select menu 18 and enter 50 minutes on the timer.
- 8 Test with a skewer to see if the centre is cooked. If it is not, select the same menu again and enter a further 5–10 minutes on the timer.
- 9 Take the bread pan out using oven gloves and leave to stand for 5 minutes before removing from the bread pan and allowing to cool.

### Banana Yoghurt Tea Bread

Menu '18' (55min)

Plain flour	200 g
Baking powder	2 tsp
Baking soda	½ tsp
Brown sugar	½ cup
Egg, medium	2
Plain yoghurt	¼ cup
Bananas, mashed	2
Butter, melted	50 g

#### Method:

- 1 Sift flour, baking powder and baking soda. Add brown sugar.
- 2 In a separate bowl mix together eggs, yoghurt and mashed banana.
- 3 Add the liquid ingredients and the cooled melted butter to the dry ingredients. Stir quickly and lightly.
- 4 Remove the kneading blade from the bread pan and line the bottom and sides with baking parchment. Pour the mixture into the bread pan.
- 5 Select menu 18 and enter 55 minutes on the timer.
- 6 Test with a skewer to see if the centre is cooked. If it is not, select the same menu again and enter a further 5–10 minutes on the timer.
- 7 Take the bread pan out using oven gloves and leave to stand for 5 minutes before removing from the bread pan and allowing to cool.

# Jam Recipes

## [32 Jam]

- Jam setter can be used instead of pectin.
- Depending on the type of pectin, it may be better to increase or decrease the amount.

### Strawberry Jam

Menu '32' (1hr 40min)

Strawberries, finely chopped	600 g
Sugar	400 g
Powdered Pectin	13 g (4 tsp)

- 1 Place half of the fruit into the bread pan, then add half of the sugar. Repeat with the remaining fruit and sugar.
- 2 Sprinkle the pectin onto the ingredients in the bread pan.
- 3 Select menu 32 and enter 1 hour 40 minutes on the timer.

### Blueberry Jam

Menu '32' (1hr 50min)

Blueberries	700 g
Sugar	400 g

- 1 Place half of the fruit into the bread pan, then add half of the sugar. Repeat with the remaining fruit and sugar.
- 2 Select menu 32 and enter 1 hour 50 minutes on the timer.

### Peach Melba

Menu '32' (1hr 40min)

Peaches, finely chopped	500 g
Raspberries	200 g
Sugar	300 g
Powdered Pectin	8 g (2¼ tsp)

- 1 Place half of the fruit into the bread pan, then add half of the sugar. Repeat with the remaining fruit and sugar.
- 2 Sprinkle the pectin onto the ingredients in the bread pan.
- 3 Select menu 32 and enter 1 hour 40 minutes on the timer.

### Frozen Berry Jam

Menu '32' (1hr 40min)

Frozen Mixed Berries	700 g
Sugar	400 g
Powdered Pectin	10 g (3 tsp)

- 1 Place half of the fruit into the bread pan, then add half of the sugar. Repeat with the remaining fruit and sugar.
- 2 Sprinkle the pectin onto the ingredients in the bread pan.
- 3 Select menu 32 and enter 1 hour 40 minutes on the timer.

# Compote Recipes

## [33 Compote]

### Spiced Apple Compote

Menu '33' (1hr 20min)

Apples, peeled, cored and diced	1000 g
Cinnamon stick	1
Cloves	2
Lemon, zest only	1
Lemon Juice	2 tbsp
Sugar	100 g
Water	75 mL

- 1 Remove the kneading blade from the bread pan.
- 2 Place ingredients in the bread pan in the order listed above. Pour water over ingredients.
- 3 Select menu 33 and enter 1 hour 20 minutes on the timer.
- 4 Stir after cooking is completed.

### Mixed Berry Compote

Menu '33' (1hr)

Mixed Berries E.g. Strawberries, Raspberries, Blueberries	800 g
Sugar	75 g
Water	2 tbsp

- 1 Remove the kneading blade from the bread pan.
- 2 Place ingredients in the bread pan in the order listed above. Pour water over ingredients.
- 3 Select menu 33 and enter 1 hour on the timer.
- 4 Stir after cooking is completed.

### Apple sauce

Menu '33' (1hr 20min)

Cooking apples, peeled, cored and diced	1000 g
Water	2 tbsp

- 1 Remove the kneading blade from the bread pan.
- 2 Place the apple in the bread pan. Pour water over ingredients.
- 3 Select menu 33 and enter 1 hour 20 minutes on the timer.
- 4 Stir after cooking is completed.

### Peach in Vanilla Syrup

Menu '33' (1hr)

Peaches, stone removed and cut into ½	1000 g
Sugar	100 g
Vanilla Pod	½
Water	125 mL

- 1 Remove the kneading blade from the bread pan.
- 2 Place ingredients in the bread pan in the order listed above. Pour water over ingredients.
- 3 Select menu 33 and enter 1 hour on the timer.
- 4 When cooking is complete, remove the peaches with a slotted spoon. Carefully pour the syrup over the fruit. Leave to cool.

# Care & Cleaning

Before cleaning, unplug your Bread Maker and allow it to cool down.

■ To avoid damaging your Bread Maker...

- Do not use anything abrasive! (cleansers, scouring pads etc)
- Do not wash any part of your Bread Maker in the dishwasher!
- Do not use benzine, thinners, alcohol, or bleach!
- After rinsing the washable parts, wipe with cloth. Always keep the Bread Maker parts clean and dry.

## Lid

Wipe with a damp cloth



## Steam vent

Wipe with a damp cloth



## Bread pan & kneading blade

Remove any leftover dough, and wash with water.



- If it is difficult to remove the kneading blade, soak in warm water for 5–10 minutes. Do not submerge the bread pan in water.



## Measuring spoon & sourdough starter spoon

Wash with water.

## Sourdough cups

Wash well with kitchen detergent and dry to prevent bacteria growth.

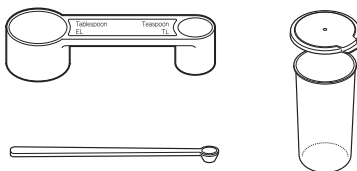

- Not dishwasher safe



## Body

Wipe with a damp cloth

- Wipe gently to avoid damaging the temperature sensor.

Temperature sensor

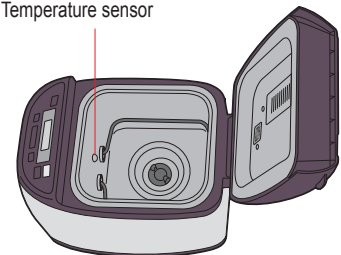

• The colour of the inside of the unit may change with use.

# Care & Cleaning

## Dispenser lid

Remove and wash with water.

- Raise the dispenser lid to an angle of approximately 75 degrees. Align the connections and pull towards you to remove or push carefully back at the same angle to attach. (Wait until the machine has cooled down first, because it will be very hot immediately after use)
- Take care not to damage or pull the seal. (Damage could lead to leakage of steam, condensation, or deformation)



## Yeast dispenser

Wipe with a damp cloth and dry naturally.

- If wipe with a dry cloth, dry yeast will not drop into the bread pan due to static.



Seal

Wipe with dry cloth when it is wet.



## Raisin nut dispenser

Remove and wash with water.



- Wash after each use to remove any residue.



## To protect the non-stick finish

Bread pan and kneading blade are coated with a non-stick finish to avoid stains and to make it easier when removing bread.

To avoid damaging it, please follow the instructions below.

- Do not use hard utensils such as a knife or a fork when removing the bread from the bread pan. When you have hard time taking out the bread from the bread pan, see P. 49.
- Ensure that the kneading blade is not embedded in the bread loaf before slicing it. If it is embedded, wait for the loaf to cool and remove it. (Do not use hard or sharp utensils such as a knife or a fork.) Be careful not to get burns as the kneading blade may still be hot.



- Use the soft sponge when cleaning the bread pan and the kneading blade. Do not use anything abrasive such as cleansers or scouring pads.



- Hard, coarse or large ingredients such as flours with whole or ground grains, sugar, or the addition of nuts and seeds may damage the non-stick finish of the bread pan. If using large chunk of ingredient, break into small pieces. Please make sure to follow the recipe quantities stated.

# Troubleshooting

Before calling for service, please check through this section.

Problem	Cause → Action
<p>My bread does not rise</p> <hr/> <p>The top of my bread is uneven</p>	<p>[All bread]</p> <ul style="list-style-type: none"> <li>● The quality of the gluten in your flour is poor, or you have not used strong flour. (Gluten quality can vary depending on temperature, humidity, how the flour is stored, and the season of harvest)           <ul style="list-style-type: none"> <li>→ Try another type, brand or another batch of flour.</li> </ul> </li> <li>● The dough has become too firm because you haven't used enough liquid.           <ul style="list-style-type: none"> <li>→ Stronger flour with higher protein content absorbs more water than others, so try adding an extra 10–20 mL of water.</li> </ul> </li> <li>● You are not using the right type of yeast.           <ul style="list-style-type: none"> <li>→ Use a dry yeast from a sachet, which has 'Easy Blend', 'Fast Action' or 'Easy Bake' written on it. This type does not require pre-fermentation.</li> </ul> </li> <li>● You are not using enough yeast, or your yeast is old. Make sure yeast sachets not open for longer than 48 hours.           <ul style="list-style-type: none"> <li>→ Use the measuring spoon provided. Check the yeast's expiry date. (Keep in refrigerator)</li> </ul> </li> <li>● The yeast has touched the liquid before kneading.           <ul style="list-style-type: none"> <li>→ Check that you have put in the ingredients in the correct order according to the instructions. (P. 12)</li> </ul> </li> <li>● You have used too much salt, or not enough sugar.           <ul style="list-style-type: none"> <li>→ Check the recipe and measure out the correct amounts using the measuring spoon provided.</li> <li>→ Check that salt and sugar is not included in other ingredients.</li> </ul> </li> </ul> <p>[Speciality bread]</p> <ul style="list-style-type: none"> <li>● Einkorn wheat was used when baking speciality bread and/or a lot of flour other than spelt flour were used.           <ul style="list-style-type: none"> <li>→ The spelt flour should be up to 60% of the entire flour when you use more than two kinds of flour other than spelt. The rye and the rice flour should be up to 40% of the entire flour and buckwheat flour should be up to 20% of the entire flour.</li> </ul> </li> </ul>
<p>My bread is full of air holes</p>	<ul style="list-style-type: none"> <li>● You have used too much yeast.           <ul style="list-style-type: none"> <li>→ Check the recipe and measure out the correct amount using the measuring spoon provided.</li> </ul> </li> <li>● You have used too much liquid.           <ul style="list-style-type: none"> <li>→ Some types of flour absorb more water than others, so try using 10–20 mL less water.</li> </ul> </li> </ul>
<p>My bread seems to have collapsed after rising.</p>	<ul style="list-style-type: none"> <li>● The quality of your flour isn't very good.           <ul style="list-style-type: none"> <li>→ Try using a different brand of flour.</li> </ul> </li> <li>● You have used too much liquid.           <ul style="list-style-type: none"> <li>→ Try using 10–20 mL less water.</li> </ul> </li> </ul>
<p>My bread has risen too much.</p>	<ul style="list-style-type: none"> <li>● You have used too much yeast/water.           <ul style="list-style-type: none"> <li>→ Check the recipe and measure out the correct amount using the measuring spoon (yeast)/sourdough cup (water) provided.</li> <li>→ Check that excess water amount is not included in other ingredients.</li> </ul> </li> <li>● You have not used enough flour.           <ul style="list-style-type: none"> <li>→ Carefully weigh the flour using scales.</li> </ul> </li> </ul>
<p>Why is my bread pale and sticky?</p>	<ul style="list-style-type: none"> <li>● You are not using enough yeast, or your yeast is old.           <ul style="list-style-type: none"> <li>→ Use the measuring spoon provided. Check the yeast's expiry date. (Keep in refrigerator)</li> </ul> </li> <li>● There has been a power failure, or the machine has been stopped during breadmaking.           <ul style="list-style-type: none"> <li>→ The machine switches off if it is stopped for more than 10 minutes. You will need to remove the bread from the bread pan and start again with new ingredients.</li> </ul> </li> </ul>
<p>There is excess flour around the bottom and sides of my bread.</p>	<ul style="list-style-type: none"> <li>● You have used too much flour, or you are not using enough liquid.           <ul style="list-style-type: none"> <li>→ Check the recipe and measure out the correct amount using scales for the flour or the sourdough cup provided for liquids.</li> </ul> </li> </ul>
<p>Why has my bread not mixed properly?</p>	<ul style="list-style-type: none"> <li>● You haven't put the kneading blade in the bread pan.           <ul style="list-style-type: none"> <li>→ Make sure the kneading blade is in the bread pan before you put in the ingredients.</li> </ul> </li> <li>● There has been a power failure, or the machine has been stopped during breadmaking.           <ul style="list-style-type: none"> <li>→ The machine switches off if it is stopped for more than 10 minutes. You might be able to start the loaf again, though this might give poor results if kneading had already begun.</li> </ul> </li> </ul>

# Troubleshooting

Before calling for service, please check through this section.

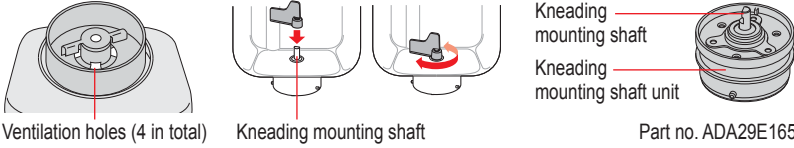
Problem	Cause → Action
<p>My bread has not been baked.</p>	<ul style="list-style-type: none"> <li>• The dough menu was selected.                     <ul style="list-style-type: none"> <li>→ The dough menu does not include a baking process.</li> </ul> </li> <li>• There has been a power failure, or the machine has been stopped during breadmaking.                     <ul style="list-style-type: none"> <li>→ The machine switches off if it is stopped for more than 10 minutes. You can try baking the dough in your oven if it has risen and proved.</li> </ul> </li> <li>• There is not enough water and the motor protection device has activated.                     <ul style="list-style-type: none"> <li>This only happens when the unit is overloaded and excessive force is applied to the motor.</li> <li>→ Visit place of purchase for a service consultation. Next time, check the recipe and measure out the correct amount using the sourdough cup provided.</li> </ul> </li> <li>• You have forgotten to attach the kneading blade.                     <ul style="list-style-type: none"> <li>→ Make sure you attach the kneading blade first (P. 12).</li> </ul> </li> <li>• The kneading mounting shaft in the bread pan is stiff and does not rotate.                     <ul style="list-style-type: none"> <li>→ If the kneading mounting shaft does not rotate when the kneading blade is attached, you will need to replace the kneading mounting shaft unit. (Consult the place of purchase or a Panasonic service centre.)</li> </ul> </li> </ul>
<p>Dough leaks out of the bottom of the bread pan.</p>	<ul style="list-style-type: none"> <li>• A small amount of dough will escape through the ventilation holes (so that it does not stop the rotating parts from rotating). This is not a fault, but check occasionally that the kneading mounting shaft rotate properly.                     <ul style="list-style-type: none"> <li>→ If the kneading mounting shaft does not rotate when the kneading blade is attached, you will need to replace the kneading mounting shaft unit. (Consult the place of purchase or a Panasonic service centre.)</li> </ul> </li> </ul> <p>(Bottom of bread pan)</p> 
<p>The sides of my bread have collapsed and the bottom is damp.</p>	<ul style="list-style-type: none"> <li>• You have left the bread in the bread pan for too long after baking.                     <ul style="list-style-type: none"> <li>→ Remove the bread promptly after baking.</li> </ul> </li> <li>• There has been a power failure, or the machine has been stopped during breadmaking.                     <ul style="list-style-type: none"> <li>→ The machine switches off if it is stopped for more than 10 minutes. You may try baking the dough in your oven.</li> </ul> </li> </ul>
<p>The kneading blade rattles.</p>	<ul style="list-style-type: none"> <li>• This is because the kneading blade fits loosely on the kneading mounting shaft. (This is not a fault)</li> </ul>
<p>I can smell burning while the bread is baking. Smoke is coming out of the steam vent.</p>	<ul style="list-style-type: none"> <li>• Ingredients may have been spilt on the heating element.                     <ul style="list-style-type: none"> <li>→ Sometimes a little flour, raisins or other ingredients may be flicked out of the bread pan during mixing. Simply wipe the heating element gently after baking once the Bread Maker has cooled down.</li> <li>→ Remove the bread pan from the Bread Maker to place ingredients.</li> </ul> </li> </ul>
<p>The kneading blade stays in the bread when I remove it from the bread pan.</p>	<ul style="list-style-type: none"> <li>• The dough is a little stiff.                     <ul style="list-style-type: none"> <li>→ Allow the bread to cool completely before removing the kneading blade carefully. Some types of flour absorb more water than others, so try adding an extra 10–20 mL of water next time.</li> </ul> </li> <li>• Crust has built up underneath the kneading blade.                     <ul style="list-style-type: none"> <li>→ Wash the kneading blade and its spindle after each use.</li> </ul> </li> </ul>
<p>The crust creases and goes soft on cooling.</p>	<ul style="list-style-type: none"> <li>• The steam remaining in the bread after baking can pass into the crust and soften it slightly.                     <ul style="list-style-type: none"> <li>→ To reduce the amount of steam, try using 10–20 mL less water or half the amount of sugar.</li> <li>→ Remove loaf from bread pan immediately after baking completed.</li> </ul> </li> </ul>
<p>How can I keep my crust crispy?</p>	<ul style="list-style-type: none"> <li>• To make your bread crispier, you could use the menu 9 or the 'Dark' crust colour option, or even bake it in the oven at 200°C/gas mark 6 for an extra 5–10 minutes.</li> </ul>
<p>My bread is sticky and slices unevenly.</p>	<ul style="list-style-type: none"> <li>• It was too hot when you sliced it.                     <ul style="list-style-type: none"> <li>→ Allow your bread to cool on rack before slicing to release the steam.</li> </ul> </li> </ul>
<p>Extra ingredients are not mixed properly in brioche.</p>	<ul style="list-style-type: none"> <li>• Some of the bread mix dough is harder to mixed extra ingredients in or to flick out some of them.                     <ul style="list-style-type: none"> <li>→ Decreased the extra ingredients into half.</li> </ul> </li> </ul>



Problem	Cause → Action
There is excess oil on the bottom of brioche. The crust is oily. My bread has big holes.	<ul style="list-style-type: none"> <li>● Did you add butter within 5 min of the beep?               <ul style="list-style-type: none"> <li>→ Do not put butter when display show remaining time until ready. (P. 15)</li> <li>Butter flavor might be weak, but it can bake.</li> </ul> </li> </ul>
My brioche did not turn out well when using bread mix.	<ul style="list-style-type: none"> <li>● Try following things.               <ul style="list-style-type: none"> <li>→ It might be baked better if yeast is decreased a little when using menu 13 or 29. (If adding yeast separately.)</li> <li>→ Follow the recipe on the bread mix, but the bread mix should be between 350–500 g.</li> <li>→ Place the dry yeast (If adding yeast separately) in the yeast dispenser, and dry ingredients and butter in the bread pan. Then place water. When adding the extra ingredients, add them later. (P. 15 or 22)</li> <li>→ The completion is different according to recipe on the bread mix.</li> </ul> </li> </ul>
The bread does not come out.	<ul style="list-style-type: none"> <li>● If the bread cannot be easily removed from the bread pan, leave the bread pan for 5–10 minutes to cool, making sure that it is not left unattended where somebody or something may get burnt. After that, shake the bread pan several times using oven gloves. (Hold the handle down so that it does not get in the way of bread.)</li> </ul>
When cooking jam, it has scorched or the kneading blade fixes and it doesn't come off.	<ul style="list-style-type: none"> <li>● The amount of the fruit was a too little, or the amount of sugar is too much.               <ul style="list-style-type: none"> <li>→ Place the bread pan in the sink and half fill the bread pan with warm water. Leave the bread pan to soak until the cooked on mixture or kneading blade loosens. After scorching is relieved, wash it with a soft sponge etc. Please be aware of the hot water.</li> </ul> </li> </ul>
The jam has boiled over.	<ul style="list-style-type: none"> <li>● Too much fruit or sugar has been used.               <ul style="list-style-type: none"> <li>→ Only use the amounts of fruit and sugar specified in the recipes on P. 44.</li> </ul> </li> </ul>
Jam is too runny and not firmly set.	<ul style="list-style-type: none"> <li>● The fruit was under or over ripe.</li> <li>● Sugar was decreased too much.</li> <li>● Cooking time was insufficient.</li> <li>● Fruit with a low pectin content was used.               <ul style="list-style-type: none"> <li>→ Use the runny jam as a sauce for desserts.</li> <li>→ Leave the jam to cool completely. The jam will continue to set as it cools.</li> </ul> </li> <li>● Depending on the type of pectin, it may be better to increase or decrease the amount of it.</li> </ul>
Can frozen fruits be used?	<ul style="list-style-type: none"> <li>● It is possible to use them.</li> </ul>
What kinds of sugar can we use on jam?	<ul style="list-style-type: none"> <li>● White caster and granulated can be used. Do not use brown sugar, diet sugar, and low calorie sugar or artificial sweetener.</li> </ul>
When making jam, can we use fruits are pickled in alcohol?	<ul style="list-style-type: none"> <li>● Do not use them. The quality is not satisfactory.</li> </ul>
The fruit has collapsed when making fruit in syrup.	<ul style="list-style-type: none"> <li>● The cooking time was too long. The fruit may have been over ripe.</li> </ul>
Dry yeast will not drop into the bread pan.	<ul style="list-style-type: none"> <li>● The timing of yeast dispenser activation is different depending on the menu programme and room temperature.</li> <li>● Yeast dispenser is wet, or there may be a static build up.               <ul style="list-style-type: none"> <li>→ Wipe with a damp cloth and dry naturally.</li> </ul> </li> <li>● Dry yeast is damped.               <ul style="list-style-type: none"> <li>→ Use new dry yeast.</li> </ul> </li> </ul>
Extra ingredients are not mixed properly in Savoury.	<ul style="list-style-type: none"> <li>● Did you add extra ingredients to the raisin nut dispenser before the beep?               <ul style="list-style-type: none"> <li>→ Extra ingredients must be added to the raisin nut before 🍷 is flashing in the display.</li> </ul> </li> </ul>

# Troubleshooting

Before calling for service, please check through this section.

Problem	Cause → Action
Extra ingredients does not fall into the bread pan from the raisin nut dispenser.	<ul style="list-style-type: none"><li>• Is the surface of the extra ingredients higher than the edge of the raisin nut dispenser? → Put the extra ingredients so that its surface is lower than the edge of the raisin nut dispenser. (P. 14) The capacity of the raisin nut dispenser is 150 g, however depending on the state and the type of ingredients, they may overflow.</li></ul>
⚡ appears on the display.	<ul style="list-style-type: none"><li>• There has been a power failure for approx. 10 minutes (the plug has been accidentally pulled out, or the breaker has been activated), or there is another problem with the power supply. → The operation will not be affected if the problem with the power supply is only momentary. The Bread Maker will operate again if its power is restored within 10 minutes, but the end result may be affected.</li></ul>
1 appears on the display.	<ul style="list-style-type: none"><li>• There has been a power failure for a certain amount of time (differs depending on the circumstances - e.g. mains power failure, unplugging, malfunctioning fuse or breaker). → Remove the dough and start again using new ingredients.</li></ul>
H01–H02 appears on the display.	<ul style="list-style-type: none"><li>• The display indicates a problem with the Bread Maker. → Consult the place of purchase or a Panasonic service centre.</li></ul>
U50 appears on the display.	<ul style="list-style-type: none"><li>• The unit is hot (above 40°C/105°F). This may occur with repeated use. → Allow the unit to cool down to below 40°C/105°F before using it again (U50 will disappear).</li></ul>

# Panasonic Warranty

## Home Appliance 12 Month Warranty from Date of Purchase

1. Subject to the conditions of this warranty Panasonic or its Authorised Service Centre will perform necessary service on the product without charge for parts or labour, if in the opinion of Panasonic, the product is found to be faulty within the warranty period. For Line Communications products (i.e. Cordless Phones, etc) the genuine battery(s) has a 3 month warranty.
2. This warranty only applies to Panasonic products purchased in Australia and sold by Panasonic Australia or its Authorised Distributors or Dealers and only where the products are used and serviced within Australia or its territories. Warranty cover only applies to service carried out by a Panasonic Authorised Service Centre and only if valid proof of purchase is presented when warranty service is requested.
3. This warranty only applies if the product has been installed and used in accordance with the manufacturer's recommendations (as noted in the operating instructions) under normal use and reasonable care (in the opinion of Panasonic). The warranty covers normal domestic use only (also Clip & Trim Professional use) and does not cover damage, malfunction or failure resulting from use of incorrect voltages, incorrect installation, accident, misuse, neglect, build-up of dirt or dust, abuse, maladjustment of customer controls, mains supply problems, thunderstorm activity, infestation by insects or vermin, tampering or repair by unauthorised persons (including unauthorised alterations), exposure to abnormally corrosive conditions or any foreign object or matter having entered the product.
4. This warranty does not cover the following items unless the fault or defect existed at the time of purchase:
  - (a) Cabinet Parts
  - (b) Microwave Oven cook plates.
  - (c) User replaceable Batteries
  - (d) Kneader mounting shaft unit and Heads, Cutters, Foils, Blades and other accessories.
  - (e) Noise or vibration that is considered normal
5. To claim warranty service, when required, you should:
  - Telephone Panasonic's Customer Care Centre on 132600 or visit our website referred to below and use the Service Centre Locator for the name/address of the nearest Authorised Service Centre.
  - Send or take the product to a Panasonic Authorised Service Centre together with your proof of purchase receipt as a proof of purchase date. Please note that freight and insurance to and / or from your nearest Authorised Service Centre must be arranged by you.
6. The warranties hereby conferred do not extend to, and exclude, any costs associated with the installation, de-installation or re-installation of a product, including costs related to the mounting, de-mounting or remounting of any screen, (and any other ancillary activities), delivery, handling, freighting, transportation or insurance of the product or any part thereof or replacement of and do not extend to, and exclude, any damage or loss occurring by reason of, during, associated with, or related to such installation, de-installation, re-installation or transit.

Panasonic Authorised Service Centres are located in major metropolitan areas and most regional centres of Australia, however, coverage will vary dependant on product. For advice on exact Authorised Service Centre locations for your product, please telephone our Customer Care Centre on 132600 or visit our website and use the Service Centre Locator.

In addition to your rights under this warranty, Panasonic products come with consumer guarantees that cannot be excluded under the Australian Consumer Law. If there is a major failure with the product, you can reject the product and elect to have a refund or to have the product replaced or if you wish you may elect to keep the goods and be compensated for the drop in value of the goods. You are also entitled to have the product repaired or replaced if the product fails to be of acceptable quality and the failure does not amount to a major failure.

If there is a major failure in regard to the product which cannot be remedied then you must notify us within a reasonable period by contacting the Panasonic Customer Care Centre. If the failure in the product is not a major failure then Panasonic may choose to repair or replace the product and will do so in a reasonable period of time from receiving notice from you.

**THIS WARRANTY CARD AND THE PURCHASE DOCKET (OR SIMILAR PROOF OF PURCHASE) SHOULD BE RETAINED BY THE CUSTOMER AT ALL TIMES**

If you require assistance regarding warranty conditions or any other enquiries, please visit the **Panasonic Australia** website **[www.panasonic.com.au](http://www.panasonic.com.au)** or contact by phone on **132 600**  
*If phoning in, please ensure you have your operating instructions available.*

**Panasonic Australia Pty. Limited**

ACN 001 592 187 ABN 83 001 592 187

1 Innovation Road, Macquarie Park NSW 2113  
[www.panasonic.com.au](http://www.panasonic.com.au)

PRO-031-F01 Issue: 6.0

02-10-2013

# Specification

Power supply	230 – 240 V ~ 50 Hz
Power consumed	505 – 550 W
Capacity	(Flour) max. 620 g min. 330 g (Dry yeast) max. 7.0 g min. 2.1 g
Capacity of raisin nut dispenser	max. 150 g raisins
Timer	Digital timer (up to 13 hours)
Dimensions (H×W×D)	approx. 38.2×26.0×38.9 cm
Weight	approx. 7.3 kg
Accessories	2 sourdough cups, measuring spoon, sourdough starter spoon

