

Dimensions

1 Indoor Unit

1.1 CS-QU24AKH

<Top View>

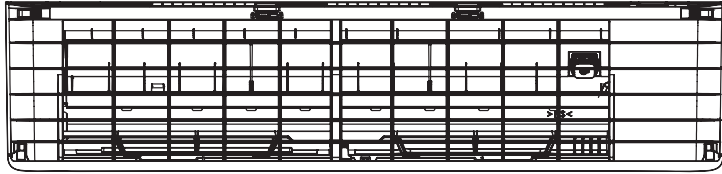

<Side View>

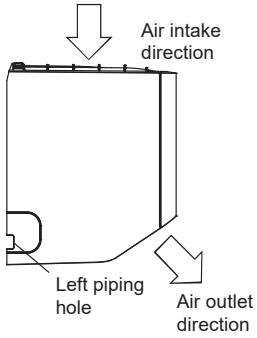

<Front View>

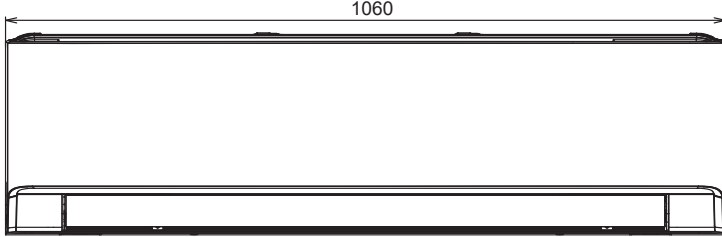

<Side View>

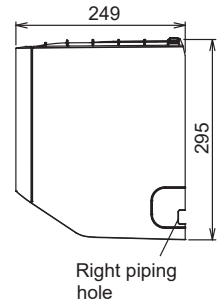

<Bottom View>

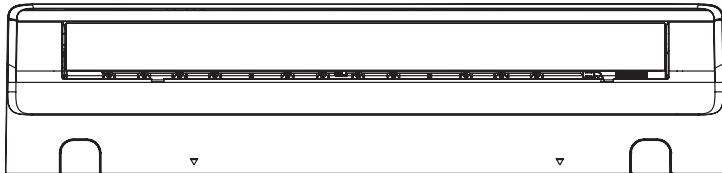

<Remote Control>

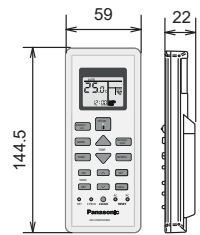

<Rear View>

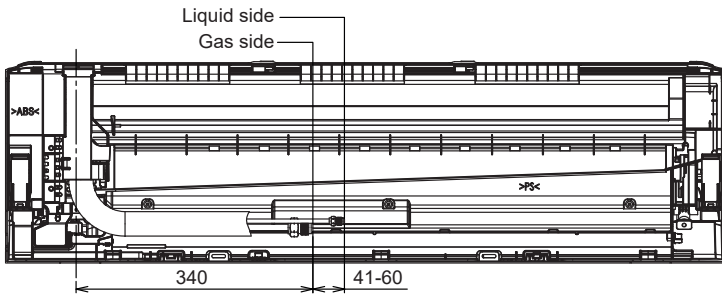

<Remote Control Holder>

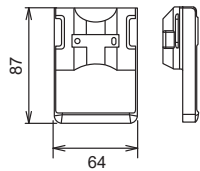

Relative position between the indoor and the installation plate <Front View>

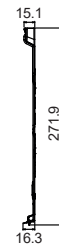
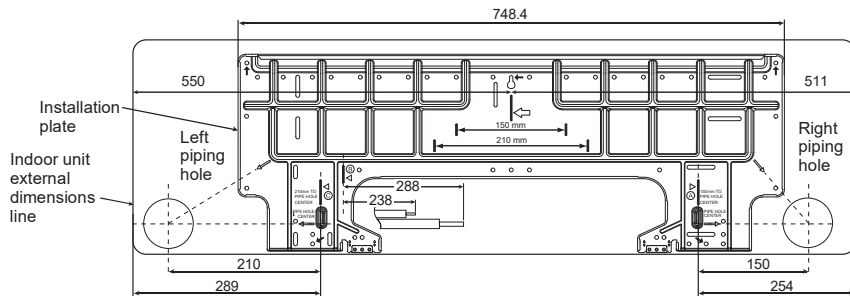

Unit : mm

2 Outdoor Unit

2.1 CU-RU24AKH

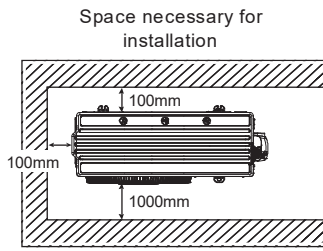

Space necessary for installation

Anchor Bolt Pitch
330 × 540

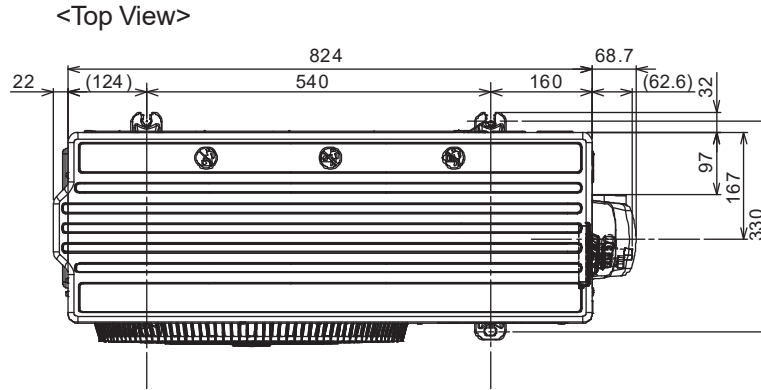

<Top View>

<Side View>

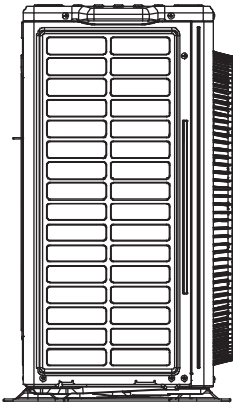

<Front View>

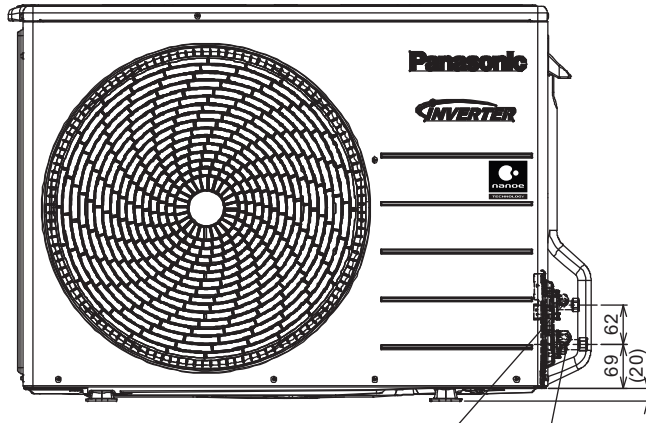

<Side View>

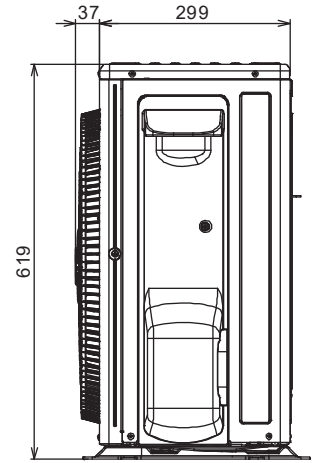

Unit : mm

3-way valve at Gas side
(Low Pressure)
2-way valve at Liquid side
(High Pressure)