



Product information



Technical documents
Download from PRO CLUB



**Building Passion,
Building Solutions.**
Panasonic Air Conditioning Systems

We face a time in which "quality air" differentiates business. It's a time for Panasonic to fully display its strengths. Our ability to assemble and build superior systems isn't just due to the rich resources we have as a comprehensive electronics manufacturer, but also to Panasonic's 100 years of tradition, where each person thinks and acts on their own initiative while working in a team to reach further heights. We do not compromise. Each of our independent selves is a one stop solution. We face our customers' challenges together with our customers and do all that we can to build effective systems. As a true partner for our customers, we strive to always be at the forefront of business.

- Please read the Installation Instructions carefully before installing the unit, and the Operating Instructions before using it.
- Specifications are subject to change without prior notice.
- The contents of this catalogue are accurate as of August 2023.
- Due to printing considerations, actual colours may vary slightly from those shown.
- All graphics are provided solely for the purpose of illustrating a point.



Do not add or replace refrigerant other than the specified type. Manufacturer is not responsible for damage or deterioration in safety due to usage of other refrigerant.

Authorised Dealer

FSV MALAYSIA_AUGUST_2023

FSV VRF SYSTEMS 2023/2024



**Panasonic Air-Conditioning Malaysia
(PACMY)**

Care Line: +603-7932 4189
Address: Lot 10, Jalan 13/2, 46200 Petaling Jaya,
Selangor Darul Ehsan.

QUALITY AIR FOR LIFE

FSV-EX Advantages



The most efficient, powerful and quiet system in Panasonic's history. There has never been a VRF system like it. It's the story of a true game changer.

Extraordinary energy-saving performance

The FSV-EX marks a revolutionary step forward in VRF efficiency. A look at the incredible EER value clearly indicates that. What's more, this high EER value is achieved even during part load operation. This shows the extraordinary energy-saving performance the FSV-EX is capable of providing.

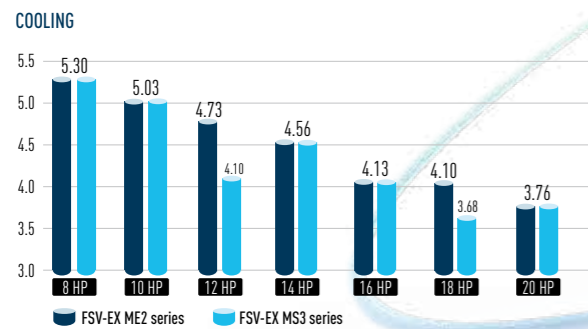

Low-noise operation

Numerous technological innovations, including an improved compressor and a newly designed bell mouth and larger fan, have dramatically reduced the outdoor noise level. The result is an even more comfortable building environment.

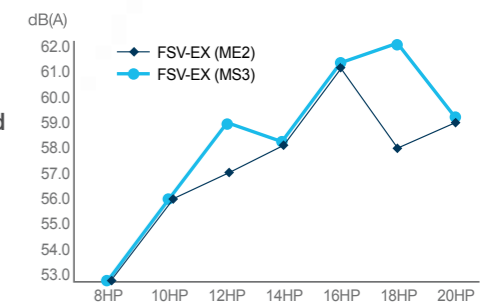

Multiple large-capacity all inverter twin rotary compressor

(more than 14HP)

Two independently controlled inverter compressors achieve high efficiency. Redesigned components in the body provide performance improvement especially in the rated cooling condition and EER performance.



Extended operation range up to 52°C

The FSV-EX can provide cooling even when the outside temperature reaches a maximum of about 52°C. And amazingly, it can still operate at 100% capacity when the outside temperature is as high as 43°C. This high power capability enables reliable operation even under extremely high temperature conditions.

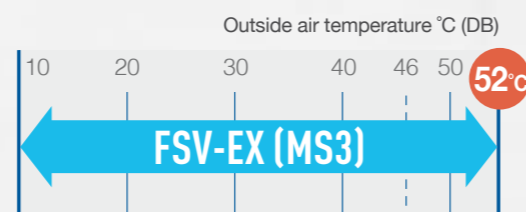

Enlarged heat exchanger surface area with triple surface*

The new heat exchanger features a triple-surface construction. Compared to the divided dual-surface construction in current models, there is no division of space and the area for heat exchange is larger. Also, highly efficient piping pattern increases heat exchange performance by 5%.

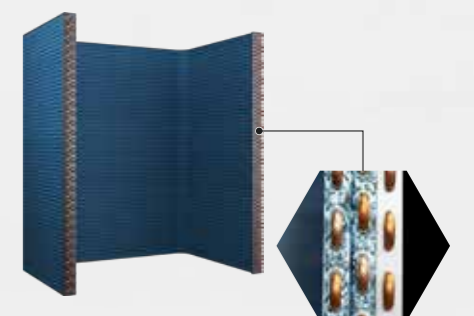

* For 8,10,12HP unit, the heat exchanger is 2 row design.

Panasonic VRF: Top In Comfort

Energy savings × Comfortable air conditioning ~Variable Evaporation Temperature (VET)~

Since 2006, all Panasonic VRF systems have included special VET technology, with variable refrigerant temperature, as standard. Our 'smart logic' system checks the temperature every 30 seconds, automatically adjusting the refrigerant temperature according to actual demand and outdoor conditions.

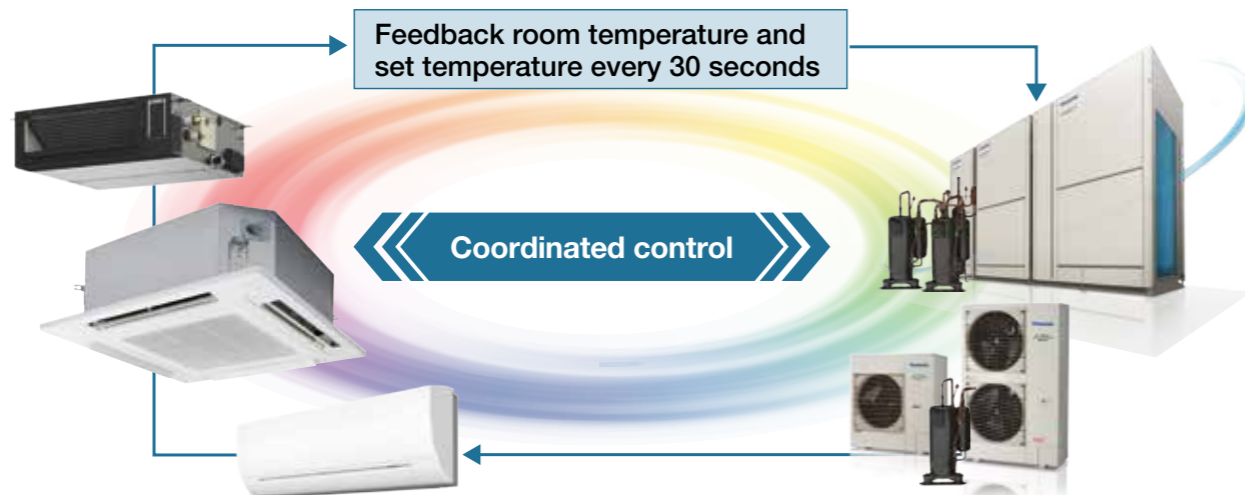

Calculate indoor refrigerant temperature and control the airflow automatically based on the difference between the setting temperature and actual indoor temperature.

Determine system refrigerant temperature and control compressor speed.

* When fan speed is Auto.

Achieves room-by-room comfort and overall system energy savings by controlling optimal refrigerant temperature and circulation volume based on all information of the entire system.

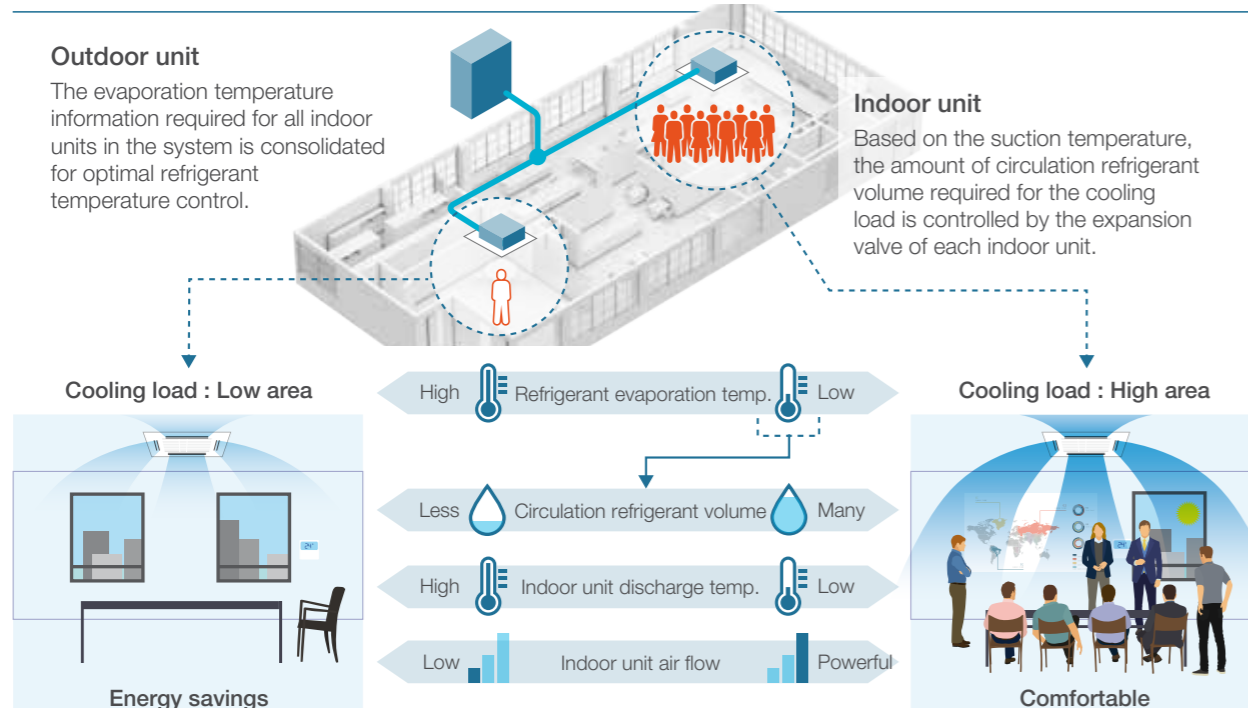

Combination of VET technology and inverter compressor achieves both energy savings and comfort by smoothly controlling the compressor to match the air conditioning load without stopping the compressor for optimum performance.

Image of room temperature change during cooling operation by scene.

1) Normal environment

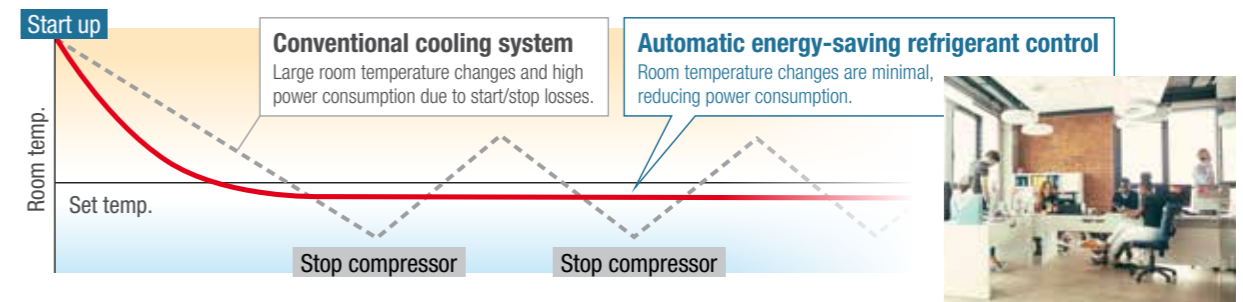

2) Environment with severe cooling load

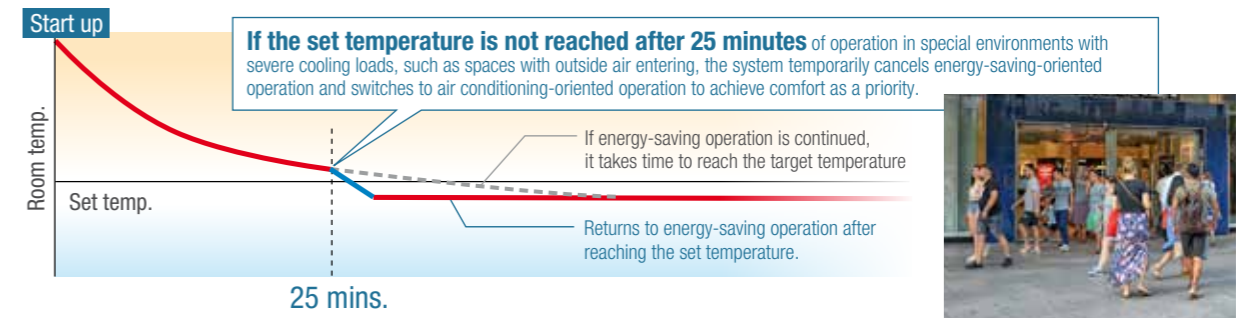

FSV-EX Advantages

Increased piping length for greater design flexibility

MS3

*1: 40 m if the outdoor unit is below the indoor unit. Elevation difference of Max. 90m in case of ODU is higher than IDU may be allowed following certain conditions.

*1, *2: Please consult with Panasonic sales engineers about the certain conditions in case of piping elevation of over 50m or level difference between indoor units over 15m is required.

Adaptable to various building types and sizes

Actual piping length : **200m**
(equivalent piping length : 210m)

Max. total piping length: 1,000m

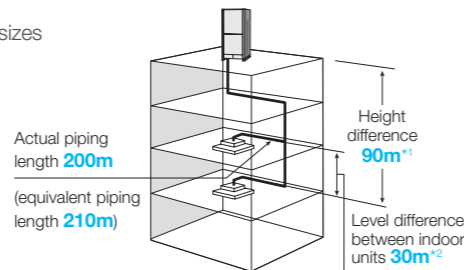

Connectable indoor/outdoor unit capacity ratio up to 130% *1

MS3

FSV systems attain maximum indoor unit connection capacity of up to 130 %*1 of the unit's connection range, depending on the outdoor and indoor models selected. So for a reasonable investment, FSV systems provide an ideal air conditioning solution for locations where full cooling/heating are not always required.

*1 82HP and above is equivalent to 80HP.

SYSTEM / HP	8	10	12	14	16	18	20	22	24	26	28	30	32	34	36	38	40	42	44	46	48	50	52
SYSTEM / kW	22.4	28.0	33.5	40.0	45.0	50.0	56.0	61.5	68.0	73.0	78.5	85.0	90.0	96.0	101.0	107.0	113.0	118.0	124.0	130.0	135.0	140.0	145.0
Maximum Number of Connectable Indoor Unit	13	16	19	23	26	29	33	36	40	43	46	50	53	56	59	63	64	64	64	64	64	64	64
Max Connectable IDU Capacity / kW : 130%	29.1	36.4	43.6	52.0	58.5	65.0	72.8	80.0	88.4	94.9	102.1	110.5	117.0	124.8	131.3	139.1	146.9	153.4	161.2	169.0	175.5	182.0	188.5
Max Connectable IDU Capacity / kW : 200%*2	44.8	56.0	67.0	80.0	90.0	100.0	112.0	123.0	136.0	146.0	157.0	170.0	180.0	192.0	202.0	214.0	226.0	236.0	248.0	260.0	270.0	280.0	290.0

SYSTEM / HP	54	56	58	60	62	64	66	68	70	72	74	76	78	80	82	84	86	88	90	92	94	96	
SYSTEM / kW	151.0	156.0	162.0	168.0	174.0	180.0	185.0	190.0	196.0	202.0	208.0	213.0	219.0	224.0	232.0	238.0	244.0	249.0	254.0	260.0	266.0	272.0	
Maximum Number of Connectable Indoor Unit	64	64	64	64	64	64	64	64	64	64	64	64	64	64	64	64	64	64	64	64	64	64	
Max Connectable IDU Capacity / kW : 130%	196.3	202.8	210.6	218.4	226.2	234.0	240.5	247.0	254.8	262.6	270.4	276.9	284.7					291.2					
Max Connectable IDU Capacity / kW : 200%*2	302.0	312.0	324.0	336.0	348.0	360.0	370.0	380.0	392.0	404.0	416.0	426.0	438.0					448.0					

Note: If more than 100% indoor units are operated with a high load, the units may not perform at the rated capacity. For the details, please consult with an authorised Panasonic dealer

*2 If the following conditions are satisfied, the effective range is "Max connectable IDU capacity / kW (with below "condition" figures" written in above No.2.

i) Obey the limited number of connectable indoor units.

ii) Simultaneous operation is limited to less than "Max connectable IDU capacity / kW (without condition) figures" written in above No.1.

Wide operating range

MS3

- Cooling operation is possible when outdoor temperature as low as 10°C DB
 - Cooling operation is possible when outdoor temperature as high as 52°C DB
- The remote controller temperature can be set from 18°C up to 30°C (Cooling)

* Depending on the type of remote controller.

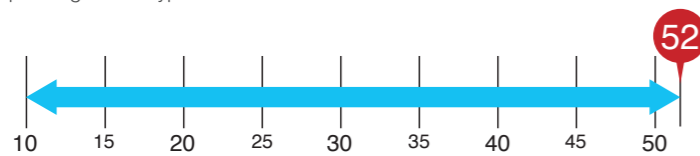

Cooling: 10°C DB ~ 52°C DB

* For further information please refer to the capacity tables in the Technical Data Book.

High external static pressure on condensers

MS3

With a newly designed fan, fan guard, motor, and casing, new models can be custom-installed on-site to provide up to 80 Pa of external static pressure. An air discharge duct prevents shortages of air circulation, allowing outdoor units to be installed on every floor of a building.

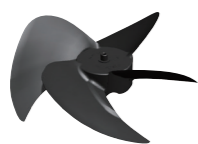

Fan

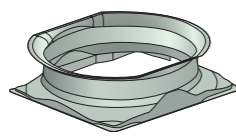

Fan Motor and Casing

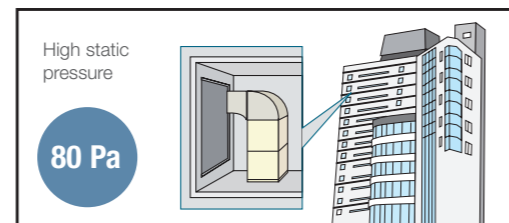

Prevents unit stoppages due to short circuits caused by geckos

MS3

One of the common causes of failures of the outdoor unit is electrical short circuits caused by geckos, small animals such as rats and insects entering the unit. The unit eliminates gaps that prevent geckos from entering the internal PCB and thus prevent operation stoppages.

Change Slit

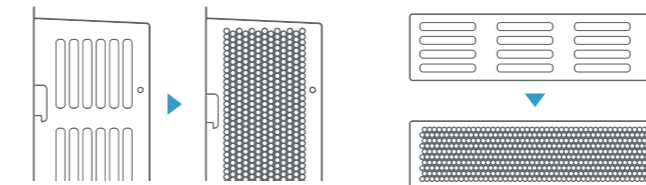
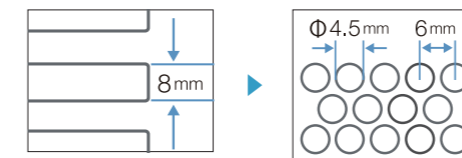

Excellent energy savings

MS3

The operation efficiency has been improved using highly efficient R410A refrigerant, new DC inverter compressor, and new heat exchanger design.

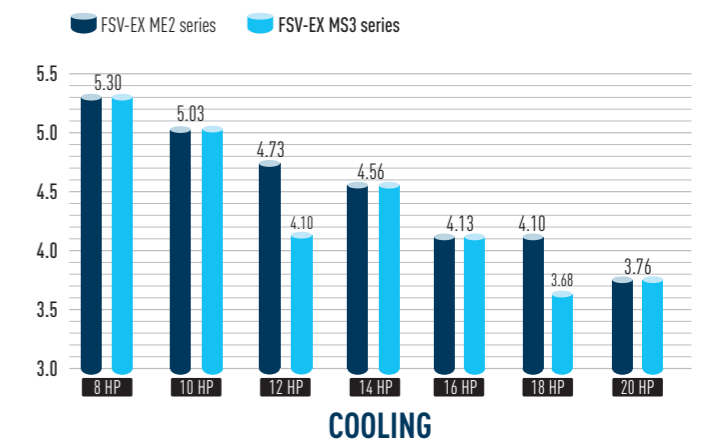

INDEX

2 FSV-EX Advantages	14 2-WAY FSV-EX MS3 Series	54 VRF Smart Connectivity+
4 Panasonic VRF: Top In Comfort	20 2-WAY Mini-FSV LE Series	58 Panasonic AC Smart Cloud
6 FSV-EX Advantages	26 nanoe™ X	60 FSV Controllers
8 Air Handling Unit Kit	28 CONEX	62 P-AIMS
10 CAC (Commercial Air Conditioning) Design Support Software	30 Indoor Units	63 Intelligent Controller
12 FSV Systems	50 Smart Connectivity and Control Solutions	64 Panasonic VRF Global Project References
	52 Panasonic Comfort Cloud	

Air Handling Unit Kit

AHU Kit connects FSV-EX and FSV outdoor units to Air Handling Units System



If you require this fresh air solution, please contact an authorized Panasonic distributor.

Connect Air Handling Unit to your FSV-EX and FSV systems for a high efficiency operation.

Application: Hotels, offices, server rooms or all large buildings where air quality control such as humidity control and fresh air are needed.

Project References

Office

Hong Kong
Red Cross Headquarters



Air Conditioning System:
VRF 2-way FSV ME1 series:
2 systems
Indoor Units: 2 units
AHU Kit: 6 units
Cooling Capacity: 280 kW / 80 USRT



Residential + Commercial

Malaysia Utropolis, Glenmarie



Air Conditioning System:
VRF 2-way FSV ME1 series:
29 systems
Indoor Units: 168 units
AHU Kit: 9 units
Cooling Capacity: 3,077 kW / 875 USRT



Air Handling Unit Kit to connect to your ventilation system

AHU Connection Kit

PCB, Power trans, Terminal block



Remote control can be easily installed on the AHU Kit box. (Remote control must be purchased separately.)



Expansion valve



Thermistor x2 (Refrigerant: E1, E3)



Thermistor x2 (Air: Tf, Tb)



Optional remote controller

Timer remote controller. CZ-RTC4



Optional parts: Following functions are available by using different type of control accessories:

CZ-RTC4 Wired remote controller

- Operation-ON/OFF
- Mode select
- Temperature setting
- * Fan operation signal can be taken from the PCB.

T10 terminal

- Input signal= Operation ON/OFF

- Remote controller prohibition
- Output signal= Operating-ON status
- Alarm output (by DC12 V)

OPTION terminal, DC12V outlet

- Output signal= Cool / Heat/Fan status
- Defrost
- Thermostat-ON

CZ-CAPBC2 Seri-para I/O unit for each indoor unit

- Temperature setting by 0-10 V or 0-140 V input signal
- Room (inlet air) temp outlet by 4-20 mA
- Mode select or/and ON/OFF control
- Fan operation control
- Operation status output/ Alarm output

Technical Zoom

- Max. piping length: 100m (actual)/ 120m (equivalent)
- Difference between longest and shortest piping from first branch: 10m
- Max. length of branch tubing: 12m
- * Other conditions to be referred the standard piping design regulations.
- Available temperature range in Heating: -20 °C (WB)-15 °C (WB)
- Available temperature range for the suction air at AHU Kit: Cool: 18-32 °C / Heat: 16-30 °C

CZ-280MAH1 // CZ-560MAH1

- The system controlled by the suction air (or return air from room) temperature as same as standard indoor unit. (Selectable mode: Automatic / Cooling / Heating / Fan / Dry (but same as Cool))
- The discharge air temperature is also controlled to prevent too-low air discharge in Cooling or too-high air discharge in Heating. (in case of VRF system)
- Demand control (Forcible thermostat-OFF control by operating current)

- Defrost operation signal, Thermo-ON/OFF states output
- External target temperature setting via Indoor/Outdoor signal interface is available with CZ-CAPBC2. (Ex. 0 - 10 V)
- Connectable with P-LINK system

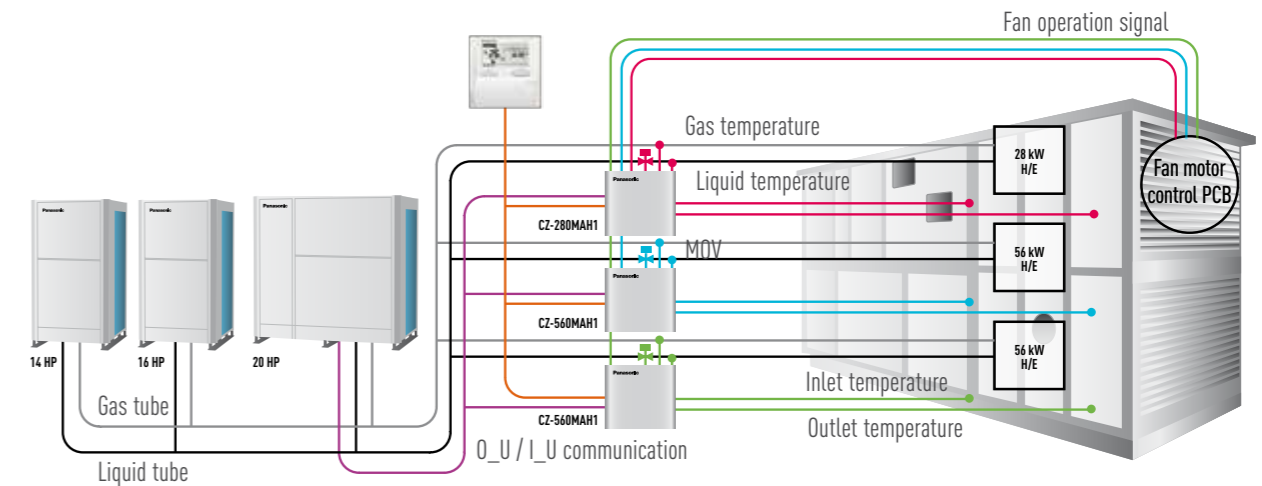

System and regulations. System overview

- A: AHU Kit controller box (with control PCB)
- B: AHU equipment (Field supplied)
- C: Remote controller (option parts)
- D: Outdoor unit
- E: Gas piping (Field supplied)
- F: Liquid piping (Field supplied)
- G: Electronic expansion valve

- H: Thermistor for gas pipe (E3)
- I: Thermistor for liquid pipe (E1)
- J: Thermistor for suction air (TA)
- K: Thermistor for discharge air (BL)
- L: Inter unit wiring
- M: Magnetic relay for operating the blower (Field supplied)

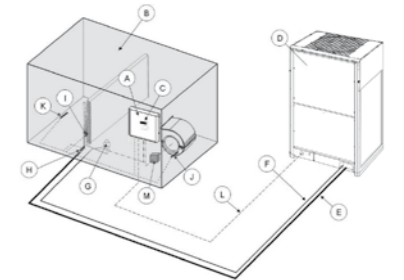

AHU Connection Kit / System Combination

	Capacity (HP)	Outdoor unit combination				AHU kit combination			
2-WAY FSV-EX MS3 Series (Space-saving Combination)	28.0 kW (10 HP)	U-10MS3H7				CZ-280MAH1			
	56.0 kW (20 HP)	U-20MS3H7				CZ-560MAH1			
	85.0 kW (30 HP)	U-12MS3H7	U-18MS3H7			CZ-560MAH1	CZ-280MAH1		
	113.0 kW (40 HP)	U-16MS3H7	U-24MS3H7			CZ-560MAH1	CZ-560MAH1		
	140.0 kW (50 HP)	U-8MS3H7	U-18MS3H7	U-24MS3H7		CZ-560MAH1	CZ-560MAH1	CZ-280MAH1	
	168.0 kW (60 HP)	U-12MS3H7	U-24MS3H7	U-24MS3H7		CZ-560MAH1	CZ-560MAH1	CZ-560MAH1	
	196.0 kW (70 HP)	U-22MS3H7	U-24MS3H7	U-24MS3H7		CZ-560MAH1	CZ-560MAH1	CZ-560MAH1	CZ-280MAH1
	224.0 kW (80 HP)	U-8MS3H7	U-24MS3H7	U-24MS3H7	U-24MS3H7	CZ-560MAH1	CZ-560MAH1	CZ-560MAH1	CZ-560MAH1
	252.0 kW (90HP)	U-18MS3H7	U-24MS3H7	U-24MS3H7	U-24MS3H7	CZ-560MAH1	CZ-560MAH1	CZ-560MAH1	CZ-560MAH1

* These are preliminary. Please consult with Panasonic sales engineers.

CAC Design Support Software



Features the unique Drawing Capture Mode providing More thorough spec-in and tender quotation support for easier, Faster completion of work.

Drawing Capture Mode Diagram

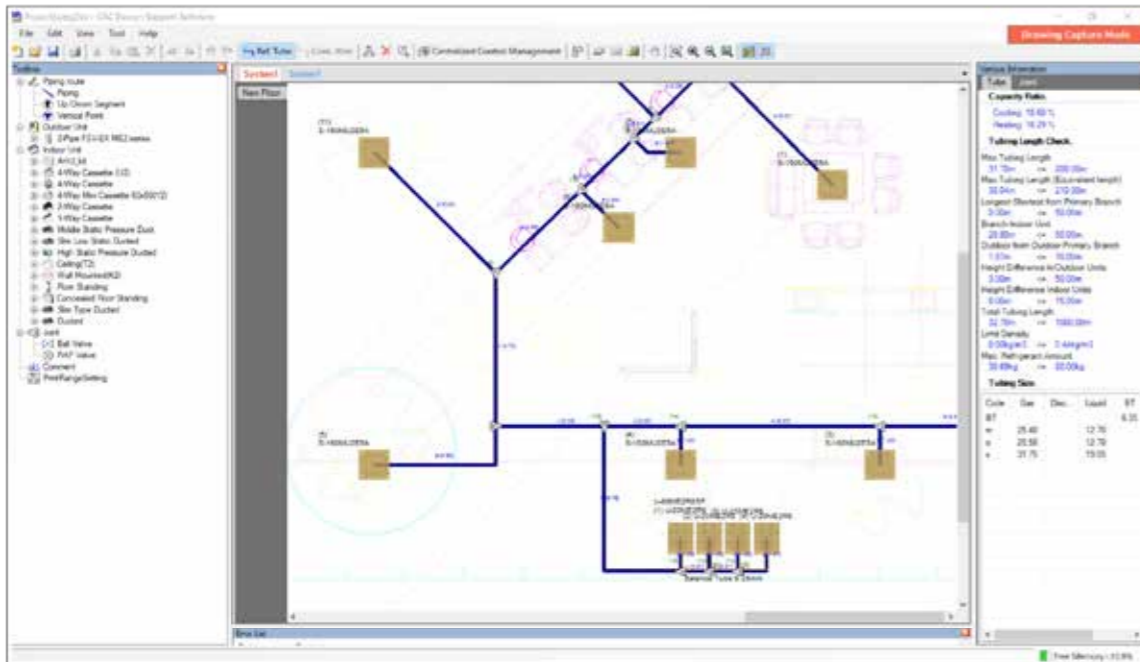

Schematic Mode Diagram

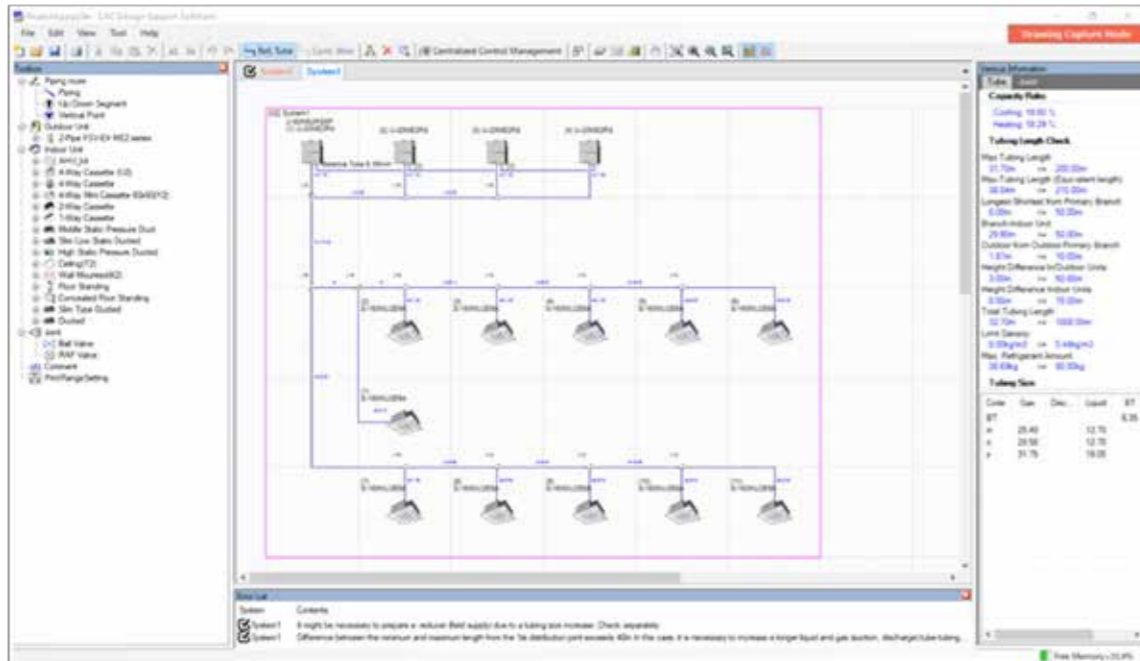

The Panasonic CAC Design Support software can be used for all Panasonic FSV

Panasonic has identified the importance of ever-increasing demands for fast and accurate responses to customer requests in our industry. More and more emphasis is being placed upon energy-efficiency in our marketplace. The ability to calculate cooling/heating loads and produce information of actual design conditions is a major advantage to any architect, consultant, contractor or end user. Panasonic understands the time-poor and demanding industry we are in and we are pleased to announce the launch of the next generation of our system design software program. The Panasonic CAC Design Support Software has been customized to make the selection and design process as quick and easy as possible. The design package utilizes system wizards and import tools to enable both simple and complex systems to be created. In addition, the system will allow outdoor and indoor units to be dragged on an interactive desktop. This allows users to create everything from realistic floor plans with detailed piping and wiring schematics to send out with quotations, through to installation guidance drawings.

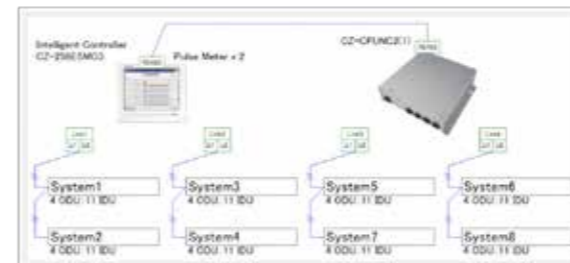
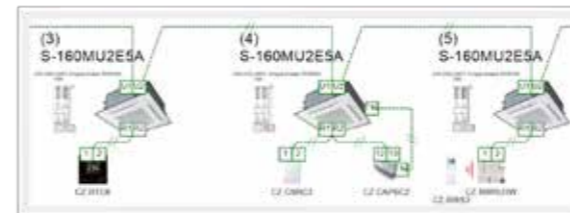

System No.	Model Name	Model No.	Capacity (kW)	Capacity (RT)	Capacity (HP)	Capacity (Btu/h)	Capacity (kW) (Cooling)	Capacity (kW) (Heating)	Capacity (RT) (Cooling)	Capacity (RT) (Heating)	Capacity (HP) (Cooling)	Capacity (HP) (Heating)	Capacity (Btu/h) (Cooling)	Capacity (Btu/h) (Heating)
1	Outdoor Unit	S-160MU2E5A	16.0	4.5	6.2	55000	16.0	16.0	4.5	4.5	6.2	6.2	55000	55000
1	Indoor Unit	S-160MU2E5A	16.0	4.5	6.2	55000	16.0	16.0	4.5	4.5	6.2	6.2	55000	55000
2	Outdoor Unit	S-160MU2E5A	16.0	4.5	6.2	55000	16.0	16.0	4.5	4.5	6.2	6.2	55000	55000
2	Indoor Unit	S-160MU2E5A	16.0	4.5	6.2	55000	16.0	16.0	4.5	4.5	6.2	6.2	55000	55000
3	Outdoor Unit	S-160MU2E5A	16.0	4.5	6.2	55000	16.0	16.0	4.5	4.5	6.2	6.2	55000	55000
3	Indoor Unit	S-160MU2E5A	16.0	4.5	6.2	55000	16.0	16.0	4.5	4.5	6.2	6.2	55000	55000
4	Outdoor Unit	S-160MU2E5A	16.0	4.5	6.2	55000	16.0	16.0	4.5	4.5	6.2	6.2	55000	55000
4	Indoor Unit	S-160MU2E5A	16.0	4.5	6.2	55000	16.0	16.0	4.5	4.5	6.2	6.2	55000	55000
5	Outdoor Unit	S-160MU2E5A	16.0	4.5	6.2	55000	16.0	16.0	4.5	4.5	6.2	6.2	55000	55000
5	Indoor Unit	S-160MU2E5A	16.0	4.5	6.2	55000	16.0	16.0	4.5	4.5	6.2	6.2	55000	55000
6	Outdoor Unit	S-160MU2E5A	16.0	4.5	6.2	55000	16.0	16.0	4.5	4.5	6.2	6.2	55000	55000
6	Indoor Unit	S-160MU2E5A	16.0	4.5	6.2	55000	16.0	16.0	4.5	4.5	6.2	6.2	55000	55000
7	Outdoor Unit	S-160MU2E5A	16.0	4.5	6.2	55000	16.0	16.0	4.5	4.5	6.2	6.2	55000	55000
7	Indoor Unit	S-160MU2E5A	16.0	4.5	6.2	55000	16.0	16.0	4.5	4.5	6.2	6.2	55000	55000
8	Outdoor Unit	S-160MU2E5A	16.0	4.5	6.2	55000	16.0	16.0	4.5	4.5	6.2	6.2	55000	55000
8	Indoor Unit	S-160MU2E5A	16.0	4.5	6.2	55000	16.0	16.0	4.5	4.5	6.2	6.2	55000	55000

Features

- Drawing Capture mode
 - Design selection from building floor drawing.
- Any kind of drawing format. (.pdf, .dxf, .dwg, etc.)
- Conventional Schematic diagram.
- Easy to use system wizards.
- Converted duties for conditions and pipework.
- Auto(CAD) [.dxf/.dwg], Excel and PDF export.
- Detailed wiring and pipework diagrams with advising terminal number.

FSV Systems

FSV systems are designed for energy savings, high efficiency, and high durability with strong cooling power even operating at high ambient temperature. Panasonic continuously apply advanced technologies to meet the requirements of diverse situations and contribute to the creation of comfortable living spaces.

FSV EX INVERTER COOLING ONLY

2-WAY FSV-EX MS3 Series

Cooling-only model with space-saving system and high capacity

NEW

Space-saving Combination Model

Cooling only Type

- Wide range of systems from 8HP to 96HP
- Class-leading EER of 5.3 (for 8HP model)
- Industry-leading low noise of 53.0 DB (8HP model)
- Cooling operation possible with outdoor temperature as high as 52°C (DB)
- Long maximum pipe length (up to 1,000 m)
- Up to 64 indoor units connectable
- External static pressure of 80 Pa



High Efficiency Combination Model

Cooling only Type

- Wide range of systems from 8HP to 64HP
- Class-leading EER of 5.3 (for 8HP model)
- Higher EER than the Space-saving Combination Model e.g., a combination of two 10HP units delivering 20HP reduces compressor load.



FSV EX INVERTER HEAT PUMP

2-WAY Mini-FSV LE2 Series

For small-scale commercial and residential use

Industry Top Class EER/COP

Cooling or Heating Type 1/3-phase

4/5/6 HP High-Durability Model

- High external static pressure 35Pa
 - Wide operation range: Cooling: -10°C to 46°C DB, Heating at: -20°C to 18°C WB
 - Refrigerant chargeless up to 50m
 - Extraordinary energy saving: 5.08* EER for 4HP model
 - Demand response (Peak cut) by optional parts.
 - Maximum number of connectable indoor units : 9*
 - Diversity ratio 50-130%
 - DC inverter technology combined with R410A for excellent efficiency
 - Demand response (Peak cut) by optional parts.
 - One ampere starting current
 - Full range of indoor units and control options
 - Auto restart from outdoor unit
 - Hi-durability outdoor unit model is available.
 - Suitable for R22 renewal projects
- * 6 HP only; 4 HP for 7 units, 5 HP for 8 units.



FSV EX INVERTER HEAT PUMP

2-WAY Mini-FSV LE1 Series

For small-scale commercial and residential use

Industry Top Class EER/COP

Cooling or Heating Type 3-phase

8/10 HP High-Durability Model

- High external static pressure 35Pa
- Wide operation range: Cooling: -10°C to 46°C DB, Heating at: -20°C to 18°C DB
- Maximum number of connectable indoor units : 13
- Diversity ratio 50-130%
- DC inverter technology combined with R410A for excellent efficiency
- Actual piping length: 150m (Total piping length: 300m)
- System difference of elevation: 50m /40m (outdoor above/below)
- Difference in elevation between indoor units: 15m
- Demand response (Peak cut) by optional parts.
- One ampere starting current
- Full range of indoor units and control options
- Auto restart from outdoor unit
- Hi-durability outdoor unit model is available.
- Suitable for R22 renewal project



2-WAY Cooling Only FSV-EX MS3 Series HIGH EFFICIENCY COMBINATION MODEL

Appearance												
	8	10	12	14	16	18	20	22	24			
HP						18	20	22	24			
Model name	U-8MS3H7	U-10MS3H7	U-12MS3H7	U-14MS3H7	U-16MS3H7	U-18MS3H7HE U-10MS3H7	U-20MS3H7HE U-10MS3H7	U-22MS3H7HE U-12MS3H7	U-24MS3H7HE U-12MS3H7			
Power supply	380/400/415V/3-phase/50Hz 380/400V/3-phase/60Hz											
Capacity	Cooling	kW	22.4	28.0	33.5	40.0	45.0	50.0	56.0	61.5	68.0	
EER / COP	Cooling	W/W	5.30	5.03	4.10	4.56	4.13	5.15	5.05	4.49	4.07	
Dimensions	H x W x D	mm	1,842 x 770 x 1,000	1,842 x 770 x 1,000	1,842 x 770 x 1,000	1,842 x 1,180 x 1,000	1,842 x 1,180 x 1,000	1,842 x 1,600 x 1,000	1,842 x 1,600 x 1,000	1,842 x 1,600 x 1,000	1,842 x 1,600 x 1,000	
Net weight		kg	210	210	210	313	313	420	420	420	420	
Electrical ratings	Cooling	Running current	A	7.14 / 6.78 / 6.54	9.62 / 9.14 / 8.81	13.6 / 13.0 / 12.5	15.3 / 14.5 / 14.0	18.4 / 17.5 / 16.8	16.6 / 15.7 / 15.2	19.2 / 18.2 / 17.5	23.1 / 22.0 / 21.2	27.9 / 26.5 / 25.5
		Power input	kW	4.23	5.57	8.17	8.77	10.9	9.70	11.1	13.7	16.7
Starting current		A	1	1	1	2	2	2	2	2	2	
Air flow rate		m³/h	13,440	13,440	13,440	13,920	13,920	26,880	26,880	26,880	26,880	
		L/s	3,733	3,733	3,733	3,867	3,867	7,467	7,467	7,467	7,467	
Refrigerant amount at shipment		kg	5.6	5.6	5.6	8.3	8.3	11.2	11.2	11.2	11.2	
External static pressure		Pa	80	80	80	80	80	80	80	80	80	
Piping connections	Gas pipe	mm (inches)	Ø19.05 (Ø3/4)	Ø22.22 (Ø7/8)	Ø28.58 (Ø1-1/8)	Ø28.58 (Ø1-1/8)	Ø28.58 (Ø1-1/8)	Ø28.58 (Ø1-1/8)	Ø28.58 (Ø1-1/8)	Ø28.58 (Ø1-1/8)	Ø28.58 (Ø1-1/8)	
	Liquid pipe	mm (inches)	Ø9.52 (Ø3/8)	Ø9.52 (Ø3/8)	Ø12.70 (Ø1/2)	Ø12.70 (Ø1/2)	Ø12.70 (Ø1/2)	Ø12.70 (Ø1/2)	Ø15.88 (Ø5/8)	Ø15.88 (Ø5/8)	Ø15.88 (Ø5/8)	
	Balance pipe	mm (inches)	Ø6.35 (Ø1/4)	Ø6.35 (Ø1/4)	Ø6.35 (Ø1/4)	Ø6.35 (Ø1/4)	Ø6.35 (Ø1/4)	Ø6.35 (Ø1/4)	Ø6.35 (Ø1/4)	Ø6.35 (Ø1/4)	Ø6.35 (Ø1/4)	
Ambient temperature operating range	Cooling: 10°C (DB)~ +52°C (DB)											
Sound pressure level	Normal mode	dB (A)	53.0	56.0	59.0	58.0	61.0	58.0	59.0	61.0	62.0	
	Silent mode (2)	dB (A)	48.0	51.0	54.0	53.0	56.0	53.0	54.0	56.0	57.0	
Sound power level	Normal mode	dB	74.0	77.0	80.0	79.0	82.0	79.0	80.0	82.0	83.0	

Appearance																	
	26	28	30	32	34	36	38	40	42	44	46	48	50	52			
HP																	
Model name	U-26MS3H7HE U-10MS3H7 U-16MS3H7	U-28MS3H7HE U-12MS3H7 U-16MS3H7	U-30MS3H7HE U-14MS3H7 U-16MS3H7	U-32MS3H7HE U-16MS3H7 U-16MS3H7	U-34MS3H7HE U-10MS3H7 U-12MS3H7 U-12MS3H7	U-36MS3H7HE U-12MS3H7 U-12MS3H7 U-12MS3H7	U-38MS3H7HE U-10MS3H7 U-12MS3H7 U-16MS3H7	U-40MS3H7HE U-12MS3H7 U-12MS3H7 U-16MS3H7	U-42MS3H7HE U-10MS3H7 U-16MS3H7 U-16MS3H7	U-44MS3H7HE U-12MS3H7 U-16MS3H7 U-16MS3H7	U-46MS3H7HE U-14MS3H7 U-16MS3H7 U-16MS3H7	U-48MS3H7HE U-16MS3H7 U-16MS3H7 U-16MS3H7	U-50MS3H7HE U-10MS3H7 U-12MS3H7 U-12MS3H7	U-52MS3H7HE U-12MS3H7 U-12MS3H7 U-16MS3H7			
Power supply	380/400/415V/3-phase/50Hz 380/400V/3-phase/60Hz																
Capacity	Cooling	kW	73.0	78.5	85.0	90.0	96.0	101.0	107.0	113.0	118.0	124.0	130.0	135.0	140.0	145.0	
EER / COP	Cooling	W/W	4.42	4.11	4.31	4.13	4.30	4.09	4.31	4.09	4.31	4.11	4.25	4.13	4.27	4.12	
Dimensions	H x W x D	mm	1,842 x 2,010 x 1,000	1,842 x 2,010 x 1,000	1,842 x 2,420 x 1,000	1,842 x 2,420 x 1,000	1,842 x 2,430 x 1,000	1,842 x 2,430 x 1,000	1,842 x 2,840 x 1,000	1,842 x 2,840 x 1,000	1,842 x 2,840 x 1,000	1,842 x 3,250 x 1,000	1,842 x 3,250 x 1,000	1,842 x 3,660 x 1,000	1,842 x 3,660 x 1,000	1,842 x 3,670 x 1,000	1,842 x 3,670 x 1,000
Net weight		kg	523	523	626	626	630	630	733	733	836	836	939	939	943	943	
Electrical ratings	Cooling	Running current	A	28.2 / 26.8 / 25.8	32.2 / 30.6 / 29.5	33.6 / 31.9 / 30.8	36.8 / 35.0 / 33.7	37.6 / 35.8 / 34.5	41.2 / 39.2 / 37.8	41.9 / 39.8 / 38.3	46.1 / 43.8 / 42.2	46.3 / 43.9 / 42.4	51.0 / 48.4 / 46.7	52.2 / 49.6 / 47.8	55.2 / 52.4 / 50.5	55.4 / 52.6 / 50.7	58.8 / 55.8 / 53.8
		Power input	kW	16.5	19.1	19.7	21.8	22.3	24.7	24.8	27.6	27.4	30.2	30.6	32.7	32.8	35.2
Starting current		A	3	3	4	4	3	3	4	4	5	5	6	6	5	5	
Air flow rate		m³/h	27,360	27,360	27,840	27,840	40,320	40,320	40,800	40,800	41,280	41,280	41,760	41,760	54,240	54,240	
		L/s	7,600	7,600	7,733	7,733	11,200	11,200	11,333	11,333	11,467	11,467	11,600	11,600	15,067	15,067	
Refrigerant amount at shipment		kg	13.9	13.9	16.6	16.6	16.8	16.8	19.5	19.5	22.2	22.2	24.9	24.9	25.1	25.1	
External static pressure		Pa	80	80	80	80	80	80	80	80	80	80	80	80	80	80	
Piping connections	Gas pipe	mm (inches)	Ø34.92 (Ø1-3/8)	Ø34.92 (Ø1-3/8)	Ø34.92 (Ø1-3/8)	Ø34.92 (Ø1-3/8)	Ø34.92 (Ø1-3/8)	Ø41.28 (Ø1-5/8)	Ø41.28 (Ø1-5/8)	Ø41.28 (Ø1-5/8)	Ø41.28 (Ø1-5/8)	Ø41.28 (Ø1-5/8)	Ø41.28 (Ø1-5/8)	Ø41.28 (Ø1-5/8)	Ø41.28 (Ø1-5/8)	Ø41.28 (Ø1-5/8)	
	Liquid pipe	mm (inches)	Ø19.05 (Ø3/4)	Ø19.05 (Ø3/4)	Ø19.05 (Ø3/4)	Ø19.05 (Ø3/4)	Ø19.05 (Ø3/4)	Ø19.05 (Ø3/4)	Ø19.05 (Ø3/4)	Ø19.05 (Ø3/4)	Ø19.05 (Ø3/4)	Ø19.05 (Ø3/4)	Ø19.05 (Ø3/4)	Ø19.05 (Ø3/4)	Ø19.05 (Ø3/4)	Ø19.05 (Ø3/4)	
	Balance pipe	mm (inches)	Ø6.35 (Ø1/4)	Ø6.35 (Ø1/4)	Ø6.35 (Ø1/4)	Ø6.35 (Ø1/4)	Ø6.35 (Ø1/4)	Ø6.35 (Ø1/4)	Ø6.35 (Ø1/4)	Ø6.35 (Ø1/4)	Ø6.35 (Ø1/4)	Ø6.35 (Ø1/4)	Ø6.35 (Ø1/4)	Ø6.35 (Ø1/4)	Ø6.35 (Ø1/4)	Ø6.35 (Ø1/4)	
Ambient temperature operating range	Cooling: 10°C (DB)~ +52°C (DB)																
Sound pressure level	Normal mode	dB (A)	62.0	63.0	63.0	64.0	63.0	64.0	64.0	64.0	65.0	65.0	65.0	66.0	65.0	66.0	
	Silent mode (2)	dB (A)	57.0	58.0	58.0	59.0	58.0	59.0	59.0	60.0	60.0	60.0	60.0	61.0	60.0	61.0	
Sound power level	Normal mode	dB	83.0	84.0	84.0	85.0	84.0	85.0	85.0	86.0	86.0	86.0	86.0	87.0	86.0	87.0	

Appearance									
	54	56	58	60	62	64			
HP									
Model name	U-54MS3H7HE U-10MS3H7 U-12MS3H7 U-16MS3H7 U-16MS3H7	U-56MS3H7HE U-12MS3H7 U-12MS3H7 U-16MS3H7 U-16MS3H7	U-58MS3H7HE U-10MS3H7 U-16MS3H7 U-16MS3H7 U-16MS3H7	U-60MS3H7HE U-12MS3H7 U-16MS3H7 U-16MS3H7 U-16MS3H7	U-62MS3H7HE U-14MS3H7 U-16MS3H7 U-16MS3H7 U-16MS3H7	U-64MS3H7HE U-16MS3H7 U-16MS3H7 U-16MS3H7 U-16MS3H7			
Power supply	380/400/415V/3-phase/50Hz 380/400V/3-phase/60Hz								
Capacity	Cooling	kW	151.0	156.0	162.0	174.0	180.0		
EER / COP	Cooling	W/W	4.27	4.13	4.27	4.13	4.23	4.13	
Dimensions	H x W x D	mm	1,842 x 4,080 x 1,000	1,842 x 4,080 x 1,000	1,842 x 4,490 x 1,000	1,842 x 4,490 x 1,000	1,842 x 4,900 x 1,000	1,842 x 4,900 x 1,000	
Net weight		kg	1,046	1,046	1,149	1,149	1,252	1,252	
Electrical ratings	Cooling	Running current	A	59.8 / 56.8 / 54.7	63.8 / 60.6 / 58.4	64.0 / 60.8 / 58.6	68.7 / 65.3 / 62.9	70.2 / 66.7 / 64.2	73.6 / 69.9 / 67.4
		Power input	kW	35.4	37.8	37.9	40.7	41.1	43.6
Starting current		A	6	6	7	7	8	8	
Air flow rate		m³/h	54,720	54,720	55,200	55,200	55,680	55,680	
		L/s	15,200	15,200	15,333	15,333	15,467	15,467	
Refrigerant amount at shipment		kg	27.8	27.8	30.5	30.5	33.2	33.2	
External static pressure		Pa	80	80	80	80	80	80	
Piping connections	Gas pipe	mm (inches)	Ø41.28 (Ø1-5/8)	Ø41.28 (Ø1-5/8)	Ø41.28 (Ø1-5/8)	Ø41.28 (Ø1-5/8)	Ø41.28 (Ø1-5/8)	Ø41.28 (Ø1-5/8)	
	Liquid pipe	mm (inches)	Ø19.05 (Ø3/4)	Ø19.05 (Ø3/4)	Ø19.05 (Ø3/4)	Ø19.05 (Ø3/4)	Ø19.05 (Ø3/4)	Ø19.05 (Ø3/4)	
	Balance pipe	mm (inches)	Ø6.35 (Ø1/4)	Ø6.35 (Ø1/4)	Ø6.35 (Ø1/4)	Ø6.35 (Ø1/4)	Ø6.35 (Ø1/4)	Ø6.35 (Ø1/4)	
Ambient temperature operating range	Cooling: 10°C (DB)~ +52°C (DB)								
Sound pressure level	Normal mode	dB (A)	66.0	66.0	66.0	67.0	66.0	67.0	
	Silent mode (2)	dB (A)	61.0	61.0	61.0	62.0	61.0	62.0	
Sound power level	Normal mode	dB	87.0	87.0	87.0	88.0	87.0	88.0	

GLOBALREMARKS

Rated conditions:	Cooling
Indoor air temperature	27°C DB / 19°C WB
Outdoor air temperature	35°C DB

These specifications are subject to change without notice.

8 / 10 / 12 HP

According to the installation site, you may choose the setting position in the depth direction of the anchor bolt from A, B or C.

- A: (Installation hole pitch) For removing tube forward
- B: (Installation hole pitch) For removing the downward
- C: (Installation hole pitch)

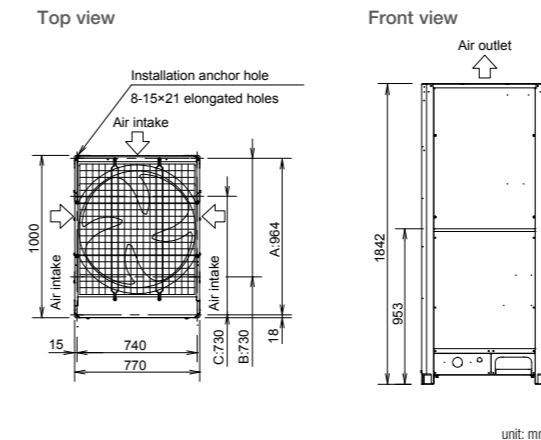

14 / 16 HP

According to the installation site, you may choose the setting position in the depth direction of the anchor bolt from A, B or C.

- A: (Installation hole pitch) For removing tube forward
- B: (Installation hole pitch) For removing the downward
- C: (Installation hole pitch)

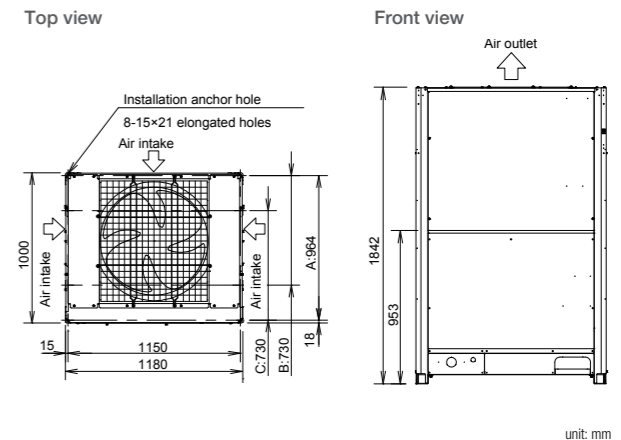

2-WAY Cooling Only FSV-EX MS3 Series **SPACE SAVING COMBINATION MODEL**

Appearance												
HP		8	10	12	14	16	18	20	22	24		
Model name		U-8MS3H7 U-10MS3H7 U-12MS3H7	U-10MS3H7 U-12MS3H7 U-14MS3H7	U-12MS3H7 U-14MS3H7 U-16MS3H7	U-14MS3H7 U-16MS3H7 U-18MS3H7	U-16MS3H7 U-18MS3H7 U-20MS3H7	U-18MS3H7 U-20MS3H7 U-22MS3H7	U-20MS3H7 U-22MS3H7 U-24MS3H7	U-22MS3H7 U-24MS3H7	U-24MS3H7		
Power supply		380/400/415V/3-phase/50Hz 380/400V/3-phase/60Hz										
Capacity	Cooling	kW	22.4	28.0	33.5	40.0	45.0	50.0	56.0	61.5	68.0	
		BTU/h	76,500	95,600	114,300	136,500	153,600	170,600	191,100	209,900	232,100	
EER / COP	Cooling	W/W	5.30	5.03	4.10	4.56	4.13	3.68	3.76	3.60	3.42	
Dimensions	H x W x D	mm	1,842 x 770 x 1,000	1,842 x 770 x 1,000	1,842 x 770 x 1,000	1,842 x 1,180 x 1,000	1,842 x 1,180 x 1,000	1,842 x 1,180 x 1,000	1,842 x 1,540 x 1,000	1,842 x 1,540 x 1,000	1,842 x 1,540 x 1,000	
		kg	210	210	210	313	313	313	366	366	366	
Electrical ratings	Cooling	Running current	A	7.14 / 6.78 / 6.54	9.62 / 9.14 / 8.81	13.6 / 13.0 / 12.5	15.3 / 14.5 / 14.0	18.4 / 17.5 / 16.8	23.0 / 21.8 / 21.0	24.6 / 23.4 / 22.5	28.2 / 26.8 / 25.9	
		Power input	kW	4.23	5.57	8.17	8.77	10.9	13.6	14.9	17.1	19.9
Starting current		A	1	1	1	2	2	2	2	2	2	
Air flow rate	m³/h	L/s	13,440	13,440	13,440	13,920	13,920	13,920	24,300	24,300	24,300	
		L/s	3,733	3,733	3,733	3,867	3,867	3,867	6,750	6,750	6,750	
Refrigerant amount at shipment		kg	5.6	5.6	5.6	8.3	8.3	8.3	9.5	9.5	9.5	
External static pressure		Pa	80	80	80	80	80	80	80	80	80	
Piping connections	Gas pipe	mm (inches)	Ø19.05 (Ø3/4)	Ø22.22 (Ø7/8)	Ø28.58 (Ø1-1/8)	Ø28.58 (Ø1-1/8)	Ø28.58 (Ø1-1/8)	Ø28.58 (Ø1-1/8)	Ø28.58 (Ø1-1/8)	Ø28.58 (Ø1-1/8)	Ø28.58 (Ø1-1/8)	
	Liquid pipe	mm (inches)	Ø9.52 (Ø3/8)	Ø9.52 (Ø3/8)	Ø12.70 (Ø1/2)	Ø12.70 (Ø1/2)	Ø12.70 (Ø1/2)	Ø15.88 (Ø5/8)	Ø15.88 (Ø5/8)	Ø15.88 (Ø5/8)	Ø15.88 (Ø5/8)	
	Balance pipe	mm (inches)	Ø6.35 (Ø1/4)	Ø6.35 (Ø1/4)	Ø6.35 (Ø1/4)	Ø6.35 (Ø1/4)	Ø6.35 (Ø1/4)	Ø6.35 (Ø1/4)	Ø6.35 (Ø1/4)	Ø6.35 (Ø1/4)	Ø6.35 (Ø1/4)	
Ambient temperature operating range		Cooling: 10°C (DB)~ +52°C (DB)										
Sound pressure level	Normal mode	dB (A)	53.0	56.0	59.0	58.0	61.0	62.0	59.0	60.0	60.0	
	Silent mode (2)	dB (A)	48.0	51.0	54.0	53.0	56.0	57.0	54.0	55.0	55.0	
Sound power level		Normal mode	dB	74.0	77.0	80.0	79.0	82.0	83.0	80.0	81.0	81.0

Appearance															
HP		26	28	30	32	34	36	38	40	42	44	46	48		
Model name		U-26MS3H7SP U-8MS3H7 U-10MS3H7 U-18MS3H7	U-28MS3H7SP U-10MS3H7 U-18MS3H7	U-30MS3H7SP U-12MS3H7 U-18MS3H7	U-32MS3H7SP U-8MS3H7 U-24MS3H7	U-34MS3H7SP U-10MS3H7 U-24MS3H7	U-36MS3H7SP U-12MS3H7 U-24MS3H7	U-38MS3H7SP U-14MS3H7 U-24MS3H7	U-40MS3H7SP U-16MS3H7 U-24MS3H7	U-42MS3H7SP U-18MS3H7 U-24MS3H7	U-44MS3H7SP U-20MS3H7 U-24MS3H7	U-46MS3H7SP U-22MS3H7 U-24MS3H7	U-48MS3H7SP U-24MS3H7		
Power supply		380/400/415V/3-phase/50Hz 380/400V/3-phase/60Hz													
Capacity	Cooling	kW	73.0	78.5	85.0	90.0	96.0	101.0	107.0	113.0	118.0	124.0	130.0	135.0	
		BTU/h	249,100	267,900	290,100	307,200	327,600	344,700	365,200	385,700	402,700	423,200	443,700	460,800	
EER / COP	Cooling	W/W	4.03	4.05	3.79	3.75	3.76	3.63	3.78	3.67	3.52	3.56	3.49	3.44	
Dimensions	H x W x D	mm	1,842 x 2,010 x 1,000	1,842 x 2,010 x 1,000	1,842 x 2,010 x 1,000	1,842 x 2,370 x 1,000	1,842 x 2,370 x 1,000	1,842 x 2,370 x 1,000	1,842 x 2,780 x 1,000	1,842 x 2,780 x 1,000	1,842 x 2,780 x 1,000	1,842 x 3,140 x 1,000	1,842 x 3,140 x 1,000	1,842 x 3,140 x 1,000	
		kg	523	523	523	576	576	576	679	679	679	732	732	732	
Electrical ratings	Cooling	Running current	A	30.6 / 29.0 / 28.0	33.1 / 31.5 / 30.3	37.8 / 35.9 / 34.6	39.6 / 37.7 / 36.3	42.6 / 40.4 / 39.0	45.9 / 43.6 / 42.0	47.8 / 45.4 / 43.7	51.4 / 48.9 / 47.1	55.9 / 53.1 / 51.2	57.5 / 54.6 / 52.6	61.4 / 58.4 / 56.3	64.9 / 61.7 / 59.4
		Power input	kW	18.1	19.4	22.4	24.0	25.5	27.8	28.3	30.8	33.5	34.8	37.2	39.3
Starting current		A	3	3	3	3	3	3	4	4	4	4	4	4	
Air flow rate	m³/h	L/s	27,360	27,360	27,360	37,740	37,740	37,740	38,220	38,220	38,220	48,600	48,600	48,600	
		L/s	7,600	7,600	7,600	10,483	10,483	10,483	10,617	10,617	10,617	13,500	13,500	13,500	
Refrigerant amount at shipment		kg	13.9	13.9	13.9	15.1	15.1	15.1	17.8	17.8	19.0	19.0	19.0	19.0	
External static pressure		Pa	80	80	80	80	80	80	80	80	80	80	80	80	
Piping connections	Gas pipe	mm (inches)	Ø34.92 (Ø1-3/8)	Ø34.92 (Ø1-3/8)	Ø34.92 (Ø1-3/8)	Ø34.92 (Ø1-3/8)	Ø34.92 (Ø1-3/8)	Ø41.28 (Ø1-5/8)	Ø41.28 (Ø1-5/8)	Ø41.28 (Ø1-5/8)	Ø41.28 (Ø1-5/8)	Ø41.28 (Ø1-5/8)	Ø41.28 (Ø1-5/8)	Ø41.28 (Ø1-5/8)	
	Liquid pipe	mm (inches)	Ø19.05 (Ø3/4)	Ø19.05 (Ø3/4)	Ø19.05 (Ø3/4)	Ø19.05 (Ø3/4)	Ø19.05 (Ø3/4)	Ø19.05 (Ø3/4)	Ø19.05 (Ø3/4)	Ø19.05 (Ø3/4)	Ø19.05 (Ø3/4)	Ø19.05 (Ø3/4)	Ø19.05 (Ø3/4)	Ø19.05 (Ø3/4)	
	Balance pipe	mm (inches)	Ø6.35 (Ø1/4)	Ø6.35 (Ø1/4)	Ø6.35 (Ø1/4)	Ø6.35 (Ø1/4)	Ø6.35 (Ø1/4)	Ø6.35 (Ø1/4)	Ø6.35 (Ø1/4)	Ø6.35 (Ø1/4)	Ø6.35 (Ø1/4)	Ø6.35 (Ø1/4)	Ø6.35 (Ø1/4)	Ø6.35 (Ø1/4)	
Ambient temperature operating range		Cooling: 10°C (DB)~ +52°C (DB)													
Sound pressure level	Normal mode	dB (A)	63.0	63.0	64.0	61.0	61.0	63.0	62.0	64.0	64.0	63.0	63.0	63.0	
	Silent mode (2)	dB (A)	58.0	58.0	59.0	56.0	56.0	58.0	57.0	59.0	59.0	58.0	58.0	58.0	
Sound power level		Normal mode	dB	84.0	84.0	85.0	82.0	82.0	84.0	83.0	85.0	85.0	84.0	84.0	84.0

Appearance															
HP		50	52	54	56	58	60	62	64	66					
Model name		U-8MS3H7 U-10MS3H7 U-18MS3H7 U-24MS3H7	U-10MS3H7 U-18MS3H7 U-24MS3H7	U-12MS3H7 U-18MS3H7 U-24MS3H7	U-8MS3H7 U-24MS3H7 U-24MS3H7	U-10MS3H7 U-24MS3H7 U-24MS3H7	U-12MS3H7 U-24MS3H7 U-24MS3H7	U-14MS3H7 U-24MS3H7 U-24MS3H7	U-16MS3H7 U-24MS3H7 U-24MS3H7	U-18MS3H7 U-24MS3H7 U-24MS3H7	U-18MS3H7 U-24MS3H7				
Power supply		380/400/415V/3-phase/50Hz 380/400V/3-phase/60Hz													
Capacity	Cooling	kW	140.0	145.0	151.0	156.0	162.0	174.0	180.0	185.0					
		BTU/h	477,800	494,900	515,400	532,400	552,900	573,400	593,900	614,300	631,400				
EER / COP	Cooling	W/W	3.72	3.75	3.65	3.63	3.64	3.55	3.65	3.59	3.50				
Dimensions	H x W x D	mm	1,842 x 3,610 x 1,000	1,842 x 3,610 x 1,000	1,842 x 3,610 x 1,000	1,842 x 3,970 x 1,000	1,842 x 3,970 x 1,000	1,842 x 3,970 x 1,000	1,842 x 4,380 x 1,000	1,842 x 4,380 x 1,000	1,842 x 4,380 x 1,000				
		kg	889	889	889	942	942	942	1,045	1,045	1,045				
Electrical ratings	Cooling	Running current	A	62.8 / 59.6 / 57.5	64.6 / 61.4 / 59.2	69.1 / 65.7 / 63.3	71.0 / 67.5 / 65.0	73.5 / 69.8 / 67.3	78.1 / 74.2 / 71.5	79.6 / 75.7 / 72.9	82.9 / 78.8 / 75.9	87.4 / 83.0 / 80.0			
		Power input	kW	37.6	38.7	41.4	43.0	44.5	47.3	47.7	50.2	52.9			
Starting current		A	5	5	5	5	5	6	6	6	6				
Air flow rate	m³/h	L/s	51,660	51,660	51,660	62,040	62,040	62,040	62,520	62,520	62,520				
		L/s	14,350	14,350	14,350	17,233	17,233	17,233	17,367	17,367	17,367				
Refrigerant amount at shipment		kg	23.4	23.4	23.4	24.6	24.6	24.6	27.3	27.3	27.3				
External static pressure		Pa	80	80	80	80	80	80	80	80	80				
Piping connections	Gas pipe	mm (inches)	Ø41.28 (Ø1-5/8)	Ø41.28 (Ø1-5/8)	Ø41.28 (Ø1-5/8)	Ø41.28 (Ø1-5/8)	Ø41.28 (Ø1-5/8)	Ø41.28 (Ø1-5/8)	Ø41.28 (Ø1-5/8)	Ø41.28 (Ø1-5/8)	Ø41.28 (Ø1-5/8)				
	Liquid pipe	mm (inches)	Ø19.05 (Ø3/4)	Ø19.05 (Ø3/4)	Ø19.05 (Ø3/4)	Ø19.05 (Ø3/4)	Ø19.05 (Ø3/4)	Ø19.05 (Ø3/4)	Ø19.05 (Ø3/4)	Ø19.05 (Ø3/4)	Ø19.05 (Ø3/4)				
	Balance pipe	mm (inches)	Ø6.35 (Ø1/4)	Ø6.35 (Ø1/4)	Ø6.35 (Ø1/4)	Ø6.35 (Ø1/4)	Ø6.35 (Ø1/4)	Ø6.35 (Ø1/4)	Ø6.35 (Ø1/4)	Ø6.35 (Ø1/4)	Ø6.35 (Ø1/4)				
Ambient temperature operating range		Cooling: 10°C (DB)~ +52°C (DB)													
Sound pressure level	Normal mode	dB (A)	64.0	65.0	65.0	63.0	64.0	64.0	65.0	65.0	66.0				
	Silent mode (2)	dB (A)	59.0	60.0	60.0	58.0	59.0	59.0	59.0	60.0	61.0				
Sound power level		Normal mode	dB	85.0	86.0	86.0	84.0	85.0	85.0	85.0	86.0	87.0			

Appearance															
HP		68	70	72	74	76	78	80	82	84	86	88	90		
Model name		U-20MS3H7 U-24MS3H7 U-24MS3H7	U-22MS3H7 U-24MS3H7 U-24MS3H7	U-24MS3H7 U-24MS3H7 U-24MS3H7	U-8MS3H7 U-18MS3H7 U-24MS3H7 U-24MS3H7	U-10MS3H7 U-18MS3H7 U-24MS3H7 U-24MS3H7	U-12MS3H7 U-18MS3H7 U-24MS3H7 U-24MS3H7	U-8MS3H7 U-10MS3H7 U-24MS3H7 U-24MS3H7	U-10MS3H7 U-24MS3H7 U-24MS3H7 U-24MS3H7	U-12MS3H7 U-24MS3H7 U-24MS3H7 U-24MS3H7	U-14MS3H7 U-24MS3H7 U-24MS3H7 U-24MS3H7	U-16MS3H7 U-24MS3H7 U-24MS3H7 U-24MS3H7	U-18MS3H7 U-24MS3H7 U-24MS3H7 U-24MS3H7		
Power supply		380/400/415V/3-phase/50Hz 380/400V/3-phase/60Hz													
Capacity	Cooling	kW	190.0	196.0	202.0	208.0	213.0	219.0	224.0	232.0	238.0	244.0	249.0	254.0	
		BTU/h	648,500	668,900	689,400	709,900	727,000	747,400	764,500	791,800	812,300	832,800	849,800	866,900	
EER / COP	Cooling	W/W	3.53	3.49											

2-WAY Cooling Only FSV-EX MS3 Series

SPACE SAVING COMBINATION MODEL



Appearance						
HP		92	94	96		
		U-92MS3H7SP	U-94MS3H7SP	U-96MS3H7SP		
Model name		U-20MS3H7 U-24MS3H7 U-24MS3H7	U-22MS3H7 U-24MS3H7 U-24MS3H7	U-24MS3H7 U-24MS3H7 U-24MS3H7		
Power supply		380/400/415V/3-phase/50Hz 380/400/3-phase/60Hz				
Capacity	Cooling	kW	260.0	266.0	272.0	
		BTU/h	887,400	907,800	928,300	
EER / COP	Cooling	W/W	3.49	3.45	3.42	
Dimensions	H x W x D	mm	1,842 x 6,340 x 1,000	1,842 x 6,340 x 1,000	1,842 x 6,340 x 1,000	
	Net weight	kg	1,464	1,464	1,464	
Electrical ratings	Cooling	Running current	A	123.0 / 116.9 / 112.7	127.2 / 120.8 / 116.4	131.3 / 124.7 / 120.2
		Power input	kW	74.5	77.0	79.5
Starting current		A	8	8	8	
Air flow rate		m ³ /h	97,200	97,200	97,200	
		L/s	27,000	27,000	27,000	
Refrigerant amount at shipment		kg	38.0	38.0	38.0	
External static pressure		Pa	80	80	80	
Piping connections	Gas pipe	mm (inches)	Ø53.98 (Ø2-1/8)*	Ø53.98 (Ø2-1/8)*	Ø53.98 (Ø2-1/8)*	
	Liquid pipe	mm (inches)	Ø22.22 (Ø7/8)	Ø22.22 (Ø7/8)	Ø22.22 (Ø7/8)	
	Balance pipe	mm (inches)	Ø6.35 (Ø1/4)	Ø6.35 (Ø1/4)	Ø6.35 (Ø1/4)	
Ambient temperature operating range		Cooling:	10°C (DB)~ +52°C (DB)			
Sound pressure level	Normal mode	dB (A)	66.0	66.0	66.0	
	Silent mode (2)	dB (A)	61.0	61.0	61.0	
Sound power level	Normal mode	dB	87.0	87.0	87.0	

* Additional 30 cc/m oil charge is necessary.

GLOBALREMARKS

Rated conditions:	Cooling
Indoor air temperature	27°C DB / 19°C WB
Outdoor air temperature	35°C DB

These specifications are subject to change without notice.

8 / 10 / 12 HP

According to the installation site, you may choose the setting position in the depth direction of the anchor bolt from A, B or C.

- A: (Installation hole pitch) For removing tube forward
- B: (Installation hole pitch) For removing the downward
- C: (Installation hole pitch)

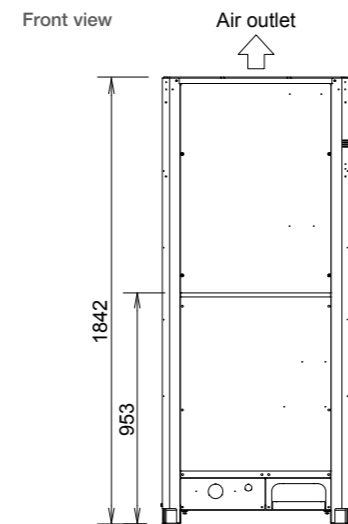
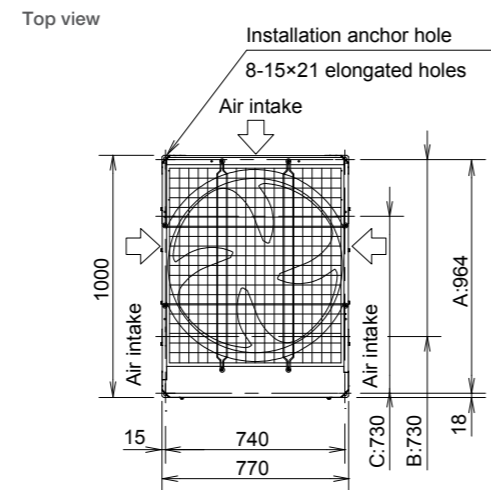

unit: mm

14 / 16 / 18 HP

According to the installation site, you may choose the setting position in the depth direction of the anchor bolt from A, B or C.

- A: (Installation hole pitch) For removing tube forward
- B: (Installation hole pitch) For removing the downward
- C: (Installation hole pitch)

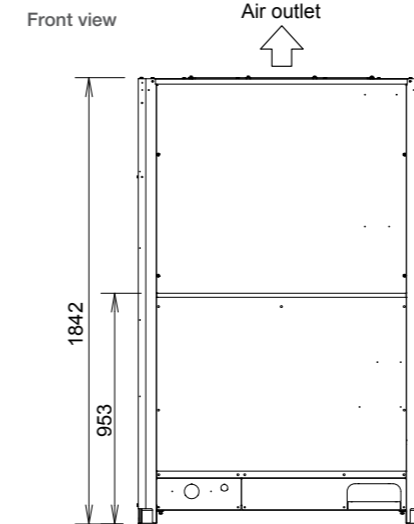
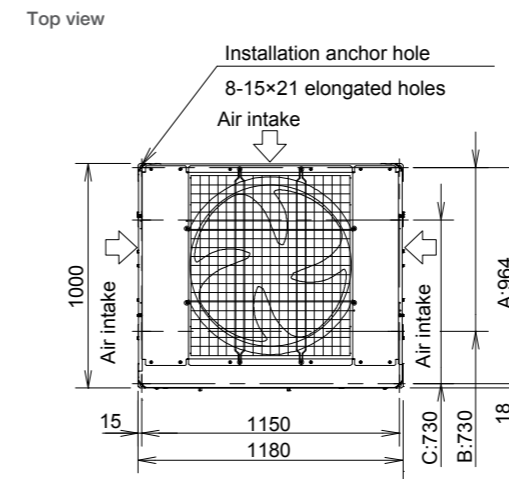

unit: mm

20 / 22 / 24 HP

According to the installation site, you may choose the setting position in the depth direction of the anchor bolt from A, B or C.

- A: (Installation hole pitch) For removing tube forward
- B: (Installation hole pitch) For removing the downward
- C: (Installation hole pitch)

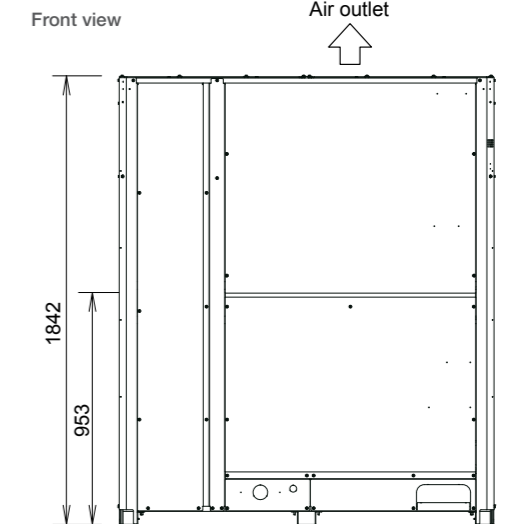
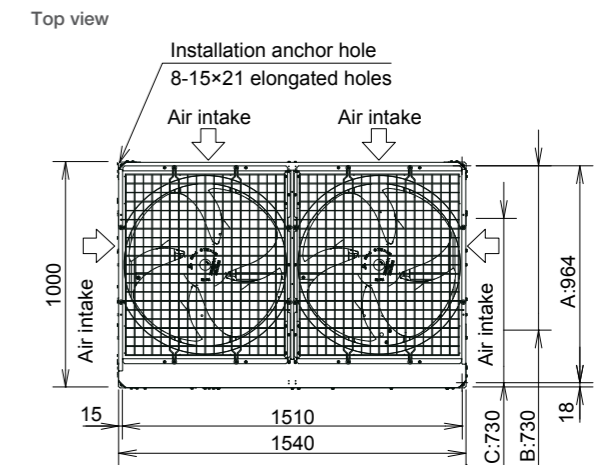

unit: mm

2-WAY Mini-FSV LE Series

High External Static Pressure 35Pa

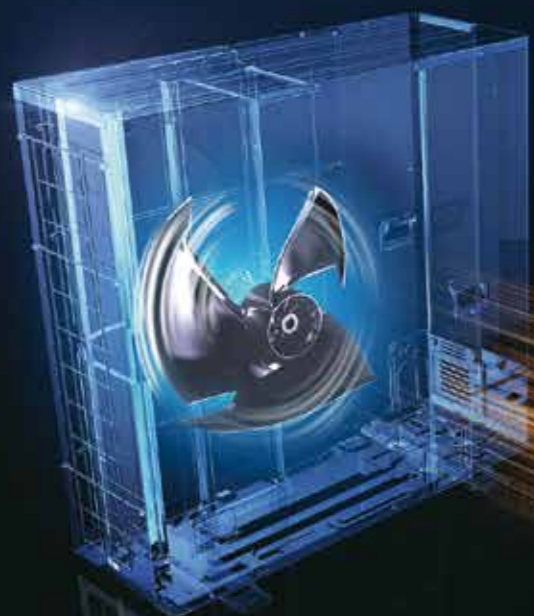

Long piping design length for greater design flexibility

LE1 LE2

Adaptable to various building types and sizes

Actual piping length 150m (equivalent piping length 175m)

Max. total piping length: 300m

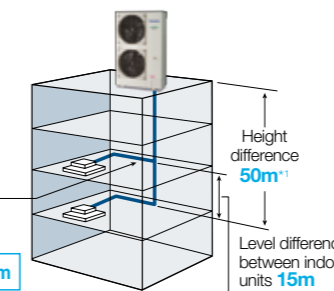

LE 1

Actual piping length 150m (equivalent piping length 175m)

Max. total piping length: 180m

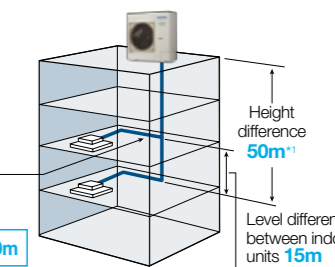

LE 2

*1: 40m if the outdoor unit is below the indoor unit.

Refrigerant chargeless up to 50m

LE2

Up to 50m of piping without additional gas charging makes installation flexible, easy and hassle-free.

A 50m pipe length is sufficient for most residential and small business buildings. When total piping length exceeds 50m, additional refrigerant charge is required.

Chargeless
Max. total piping length: 50m

Charge
Max. total piping length: 180m (Actual length: 150m)

[Sample piping lay-out]

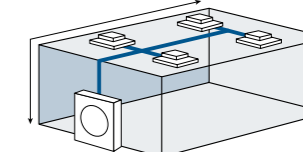

High external static pressure 35Pa

LE1 LE2

When unit is installed on a narrow balcony and exposed to the sun, the fence at the front side would restrict hot air from being discharged. Heat accumulated in an enclosure can cause over-heating. This could potentially result in damage or shorten the product's life span. A high external static pressure sends the air further away from the outdoor unit and through the fence. This provides better air circulation and distribution.



Previous model - Low pressure

When the pressure is low, hot air will accumulate in the unit thus affecting its work performance and of the unit above it as well.

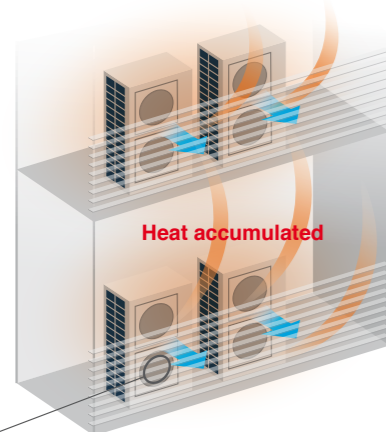

Previous fan

High electrostatic pressure disrupted the airflow of the previous fan, lowering the air pressure and preventing hot air from being discharged far enough.



LE series - High pressure

But with a high pressure of 35Pa, hot air is sent further away preventing overheating inside the outdoor unit enclosure.

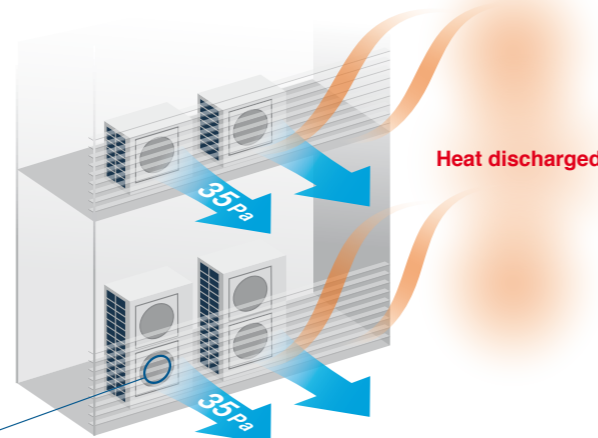

LE series fan

The new LE Series fan has ribs extending near the blade tips, in a structure that resists deformation. During high electrostatic pressure, this blade shape suppresses disruptions in the airflow, and a high air pressure of 35 Pa discharges the hot air a sufficient distance.



Compact design

LE1 LE2

Also, since Mini VRF LE Series is a single unit, it is possible to install the unit in more various places compared to the Single Split system.

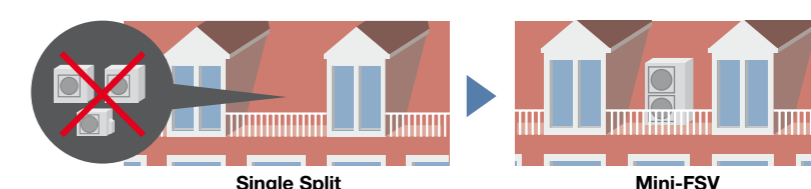

Short height of 996mm

LE2

In addition to raising efficiency, we have made the outdoor unit more compact. It can now be installed in places that were previously too small.

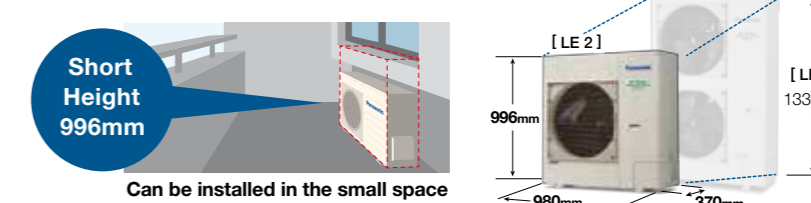

Up to 13 indoor units connectable

LE1 LE2

An expansion from Panasonic VRF line up, the Mini FSV is compatible with the same indoor units and controls as the rest of the FSV range.

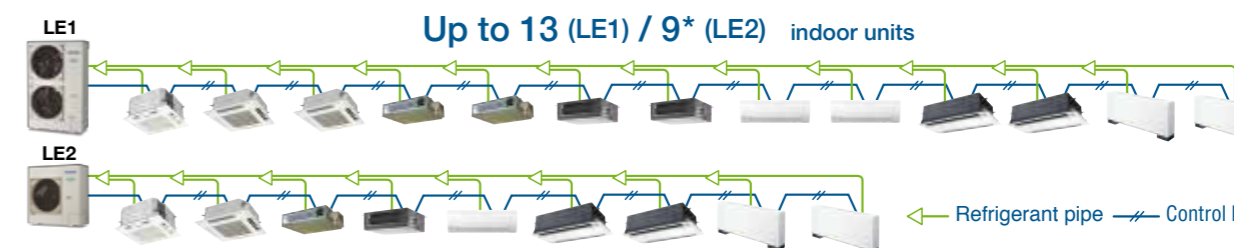

* Use any of the 22 type indoor models. Depending on the size or type of indoor unit, tubing size shall be changed. Please refer manuals for details.
* Diversity ratio 50-130%
* 6 HP only; 4 HP for 7 units, 5 HP for 8 units.

2-WAY Mini-FSV LE Series

High efficiency

LE1 LE2

The operation efficiency has been improved using highly efficient R410A refrigerant, a DC Inverter compressor, DC motor and a heat exchanger design.

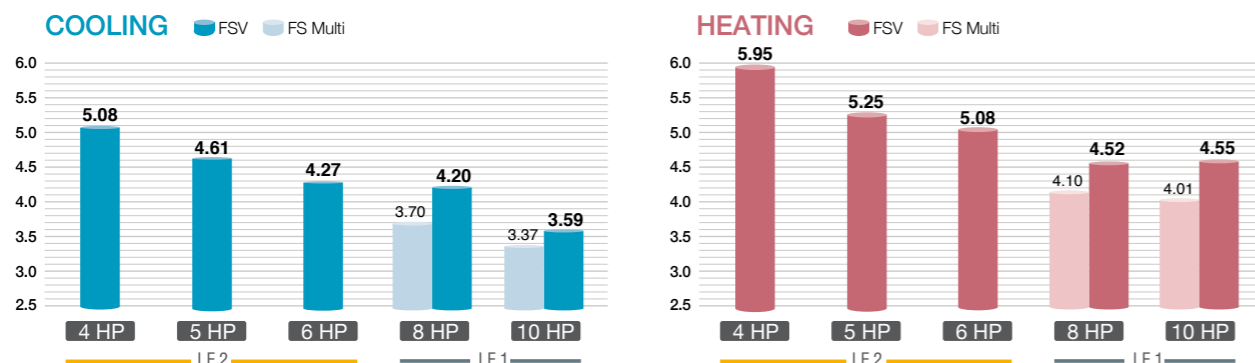

Energy savings design

LE1 LE2

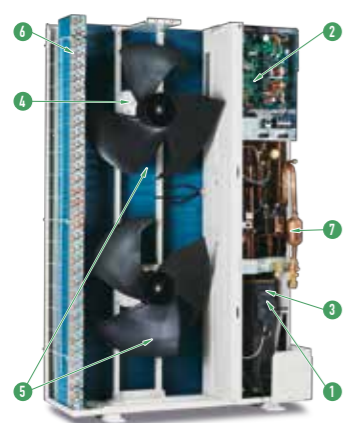

- 1 Panasonic Inverter Compressor** A large-capacity inverter compressor has been adopted. The inverter compressor is superior in performance with improved partial-load capacity.
- 2 Printed Circuit Board** The number of PCB is 2 pieces for making maintenance easier.
- 3 Accumulator** A large accumulator has been adopted to maintain compressor reliability because of the increased refrigerant quantity, which allows an extended max piping length.
- 4 DC Fan Motor** Checking load and outside temperature, the DC motor is controlled for optimum air volume.
- 5 Newly Designed Fan** The newly designed fan blades have been developed to inhibit air turbulence and to increase efficiency. As fan diameter has been increased its size, the air volume has been increased whilst maintaining a same sound level.
- 6 Heat Exchanger & Copper Tubes** The heat exchanger size and the copper tube sizes in the heat exchanger have been redesigned to increase efficiency.
- 7 Oil Separator** A centrifugal separator has been adopted to improve oil separation efficiency and reduce refrigerant pressure loss.

Flexible demand response with the optional terminal block

LE1 LE2

Demand Response

Featuring inverter control technology, all Panasonic Mini FSV systems are Demand Response Management (DRM) ready. With this control, power consumption at times of peak load can be set in three steps to deliver optimum performance. This helps to reduce annual power consumption with minimal loss in comfort.

*Terminal block supplied as optional kit. (CZ-CAPDC3) Please ask you dealer.

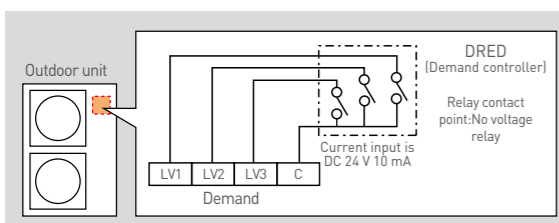

Flexible Demand Response with the CZ-CAPDC2^{*1}

Setting is possible as 0% or in the range from 40 to 100% (in steps of 5%). At the time of shipping, setting has been done to the three steps of 0%, 70% and 100%.

^{*1} An outdoor Seri-Para I/O unit (CZ-CAPDC2) is required for demand input signal.
^{*} Demand timer setting for high spec remote controller is available.

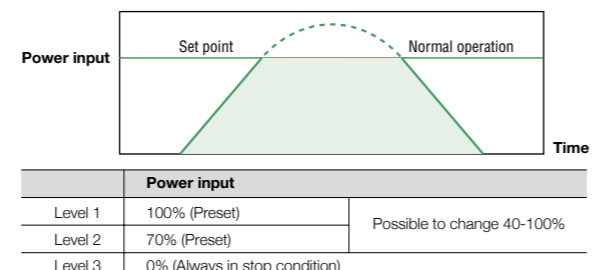

Wide operating range

LE1 LE2

- Cooling operation is possible even when outdoor temperature is as low as -10°C DB.
- Cooling operation is possible even when outdoor temperature is as high as 46°C DB.
- Heating operation is possible even when outdoor temperature is as low as -20°C WB.

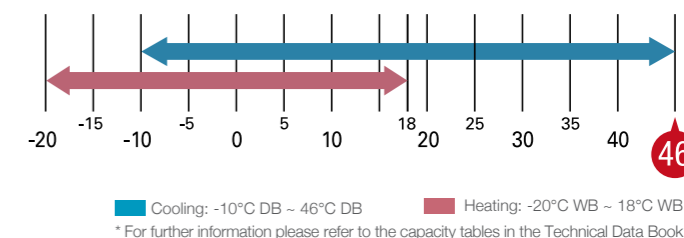

The remote controller temperature can be set from 18°C up to 30°C (Cooling), 16°C up to 30°C (Heating)*1.
^{*1} Depending on the type of remote controller.

Blue fin condenser

LE1 LE2

The anti-corrosion Blue Fin treatment of the heat exchanger provides greater resistance against corrosion. All models are equipped with Blue Fin condenser.

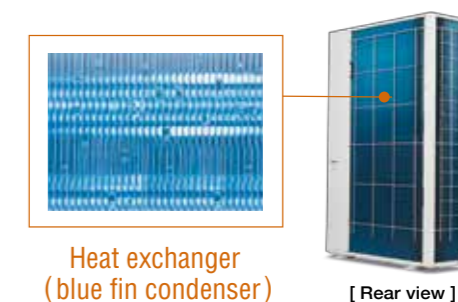

High durability outdoor unit

LE1 LE2

Corrosion-resistance treated for high resistance to rust and salty air to assure long-lasting performance.

Note: Selecting this unit does not completely eliminate the possibility of rust developing. For details concerning unit installation and maintenance, please consult an authorised dealer.
^{*} Specific model with suffix "E" has this treatment.

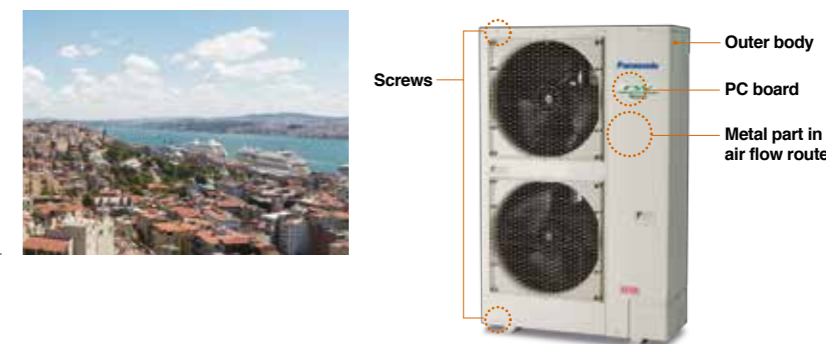

Quiet operation mode

LE1 LE2

- Quiet operation mode reduces outdoor unit operating sound down to 7dB than rating.
- 3-step set point is available.
- External input signal is also available.

^{*} Timer setting of quiet operation mode is available in High-spec Remote Controller (CZ-RTC5B/CZ-RTC6 series).



2-WAY Mini-FSV LE2 Series

HP	4			4			5			5			6			6																																											
Model name	U-4LE2H4			U-4LE2H7			U-5LE2H4			U-5LE2H7			U-6LE2H4			U-6LE2H7																																											
Power supply	220/230/240V/1-phase/50Hz 220/230V/1-phase/60Hz			380/400/415V/3-phase/50Hz 380/400V/3-phase/60Hz			220/230/240V/1-phase/50Hz 220/230V/1-phase/60Hz			380/400/415V/3-phase/50Hz 380/400V/3-phase/60Hz			220/230/240V/1-phase/50Hz 220/230V/1-phase/60Hz			380/400/415V/3-phase/50Hz 380/400V/3-phase/60Hz																																											
Voltage	220V	230V	240V	380V	400V	415V	220V	230V	240V	380V	400V	415V	220V	230V	240V	380V	400V	415V																																									
Capacity	Cooling		kW			12.1			12.1			14.0			14.0			15.5			15.5																																						
	Heating		kW			12.5			12.5			16.0			16.0			16.5			16.5																																						
EER/COP	Cooling		W/W			5.08			5.08			4.61			4.61			4.27			4.27																																						
	Heating		W/W			5.95			5.95			5.25			5.25			5.08			5.08																																						
Dimensions H x W x D	mm			996 x 980 x 370			996 x 980 x 370			996 x 980 x 370			996 x 980 x 370			996 x 980 x 370			996 x 980 x 370																																								
Net weight	kg			106			106			106			106			106			106																																								
Electrical ratings	Cooling	Running current	A			11.90			11.40			10.90			3.89			3.69			3.56			15.20			14.50			13.90			4.91			4.67			4.50			18.10			17.30			16.60			5.87			5.57			5.37		
		Power input	kW			2.38			2.38			2.38			2.38			3.04			3.04			3.04			3.04			3.04			3.63			3.63			3.63			3.63			3.63			3.63											
	Heating	Running current	A			10.60			10.10			9.70			3.47			3.29			3.18			15.20			14.60			14.0			4.93			4.68			4.51			16.20			15.50			14.90			5.25			4.99			4.81		
		Power input	kW			2.10			2.10			2.10			2.10			2.10			3.05			3.05			3.05			3.05			3.05			3.25			3.25			3.25			3.25			3.25			3.25								
Starting current	A			1			1			1			1			1			1			1			1			1			1			1			1			1			1			1													
Air flow rate	m ³ / min		69			69			72			72			74			74			74			74																																			
	L/s		1,150			1,150			1,200			1,200			1,233			1,233			1,233			1,233																																			
Refrigerant amount at shipment	kg			R410A 6.70			R410A 6.70			R410A 6.70			R410A 6.70			R410A 6.70			R410A 6.70			R410A 6.70																																					
Piping connection	Gas pipe		mm (inches)			Ø15.88 (Ø5/8)			Ø15.88 (Ø5/8)			Ø15.88 (Ø5/8)			Ø15.88 (Ø5/8)			Ø15.88 (Ø5/8)			Ø15.88 (Ø5/8)																																						
	Liquid pipe		mm (inches)			Ø9.52 (Ø3/8)			Ø9.52 (Ø3/8)			Ø9.52 (Ø3/8)			Ø9.52 (Ø3/8)			Ø9.52 (Ø3/8)			Ø9.52 (Ø3/8)																																						
Ambient temperature operating range	Cooling		-10°CDB~+46°CDB			-10°CDB~+46°CDB			-10°CDB~+46°CDB			-10°CDB~+46°CDB			-10°CDB~+46°CDB			-10°CDB~+46°CDB			-10°CDB~+46°CDB																																						
	Heating		-20°CWB~+18°CWB			-20°CWB~+18°CWB			-20°CWB~+18°CWB			-20°CWB~+18°CWB			-20°CWB~+18°CWB			-20°CWB~+18°CWB			-20°CWB~+18°CWB																																						
Sound pressure level (Cooling)	Normal mode		dB(A)			52.0			52.0			53.0			53.0			54.0			54.0																																						
	Silent mode (3)		dB(A)			45.0			45.0			46.0			46.0			47.0			47.0																																						
Sound power level (Cooling)	Normal mode		dB			69.0			69.0			71.0			71.0			73.0			73.0																																						
	Silent mode (3)		dB			69.0			69.0			71.0			71.0			73.0			73.0																																						

Global remarks	Rated conditions:		Cooling	Heating
	Indoor air temperature		27°C DB / 19°C WB	20°C DB
	Outdoor air temperature		35°C DB	7°C DB / 6°C WB

These specifications are subject to change without notice.

Dimensions

U-4LE2H4 / U-4LE2H7
U-5LE2H4 / U-5LE2H7
U-6LE2H4 / U-6LE2H7

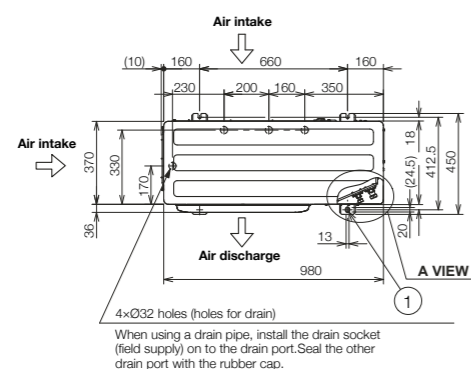

- Mounting hole (4-R6.5), anchor bolt : M10
- Refrigerant tubing (liquid tube), flared connection (Ø9.52)
- Refrigerant tubing (gas tube), flared connection (Ø15.88)
- Refrigerant tubing port
- Electrical wiring port (Ø13)
- Electrical wiring port (Ø22)
- Electrical wiring port (Ø27)
- Electrical wiring port (Ø35)

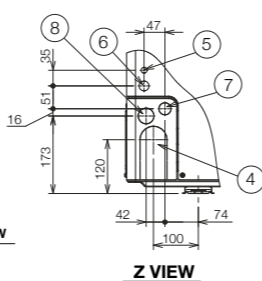
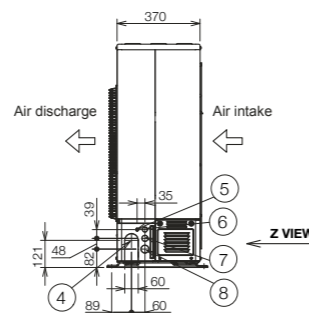
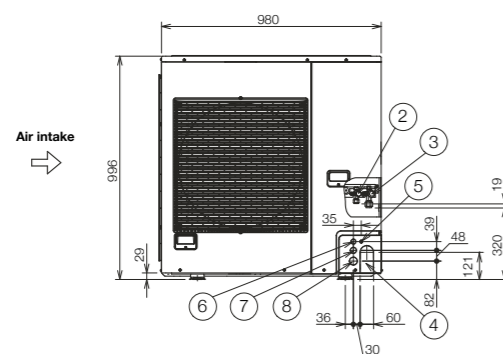
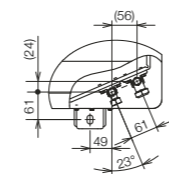

Unit: mm

2-WAY Mini-FSV LE1 Series

HP	8			10																			
Model name	U-8LE1H7			U-10LE1H7																			
Power supply	380/400/415V/3-phase/50Hz 380/400V/3-phase/60Hz			380/400/415V/3-phase/50Hz 380/400V/3-phase/60Hz																			
Voltage	380V	400V	415V	380V	400V	415V																	
Capacity	Cooling		kW			22.4			28.0														
	Heating		kW			25.0			28.0														
EER/COP	Cooling		W/W			4.20			3.59														
	Heating		W/W			4.52			4.55														
Dimensions H x W x D	mm			1,500 x 980 x 370			1,500 x 980 x 370																
Net weight	kg			132			133																
Electrical ratings	Cooling	Running current	A			8.70			8.25			7.95			12.7			12.1			11.7		
		Power input	kW			5.33			5.33			5.33			7.80			7.80			7.80		
	Heating	Running current	A			9.05			8.60			8.25			10.0			9.55			9.20		
		Power input	kW			5.53			5.53			5.53			6.15			6.15			6.15		
Starting current	A			1			1			1			1			1			1				
Air flow rate	m ³ / min			150			150			160			160			160							
	L/s			2,500			2,500			2,667			2,667			2,667							
Refrigerant amount at shipment	kg			R410A 6.30			R410A 6.30			R410A 6.60			R410A 6.60			R410A 6.60							
Piping connection	Gas pipe		mm (inches)			Ø19.05 (Ø3/4)			Ø19.05 (Ø3/4)			Ø22.22 (Ø7/8)			Ø22.22 (Ø7/8)								
	Liquid pipe		mm (inches)			Ø9.52 (Ø3/8)			Ø9.52 (Ø3/8)			Ø9.52 (Ø3/8)			Ø9.52 (Ø3/8)								
Ambient temperature operating range	Cooling: -10°CDB~+46°CDB, Heating: -20°CWB~+18°CWB			Cooling: -10°CDB~+46°CDB, Heating: -20°CWB~+18°CWB			Cooling: -10°CDB~+46°CDB, Heating: -20°CWB~+18°CWB			Cooling: -10°CDB~+46°CDB, Heating: -20°CWB~+18°CWB			Cooling: -10°CDB~+46°CDB, Heating: -20°CWB~+18°CWB										
Sound pressure level (Cooling)	Normal mode		dB(A)			59.0			59.0			62.0			62.0								
	Silent mode (3)		dB(A)			52.0			52.0			55.0			55.0								
Sound power level (Cooling)	Normal mode		dB			80.0			80.0			83.0			83.0								
	Silent mode (3)		dB			80.0			80.0			83.0			83.0								

Global remarks	Rated conditions:		Cooling	Heating
	Indoor air temperature		27°C DB / 19°C WB	20°C DB
	Outdoor air temperature		35°C DB	7°C DB / 6°C WB

These specifications are subject to change without notice.

Dimensions

U-8LE1H7 / U-10LE1H7

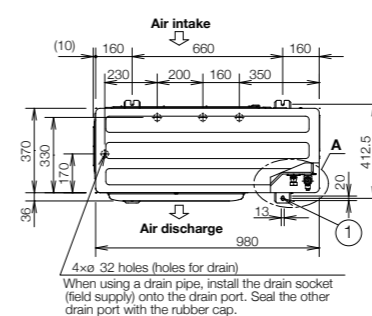

- Mounting hole (4-R6.5), anchor bolt : M10
- Refrigerant tubing (liquid tube), flared connection (Ø9.52) for 8-10 HP finally.
- Refrigerant tubing (gas tube), flared connection (Ø19.05)
- Refrigerant tubing port
- Electrical wiring port (Ø13)
- Electrical wiring port (Ø22)
- Electrical wiring port (Ø27)
- Electrical wiring port (Ø35)

For U-10LE1H7
The tubing of the gas main has a diameter of Ø22.22, but the connection to the service valve of the outdoor unit has a diameter of Ø19.05, so a flare has to be used. Consequently, be sure to use the enclosed joint tube B and joint tube A in making connections (brazing).

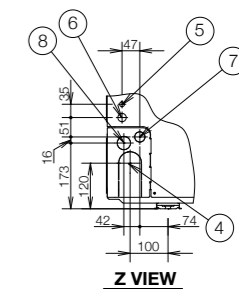
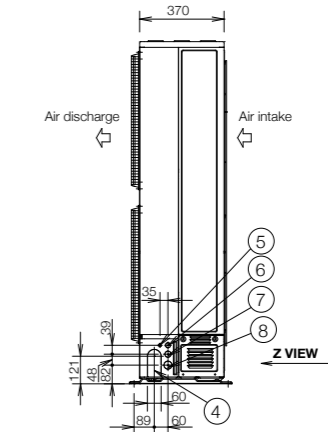
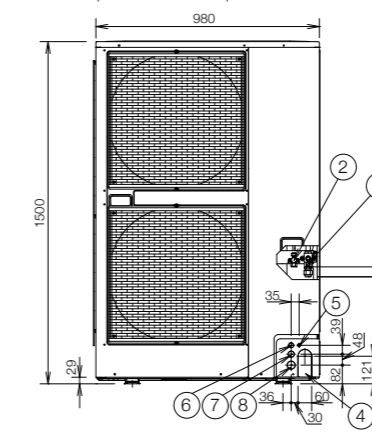
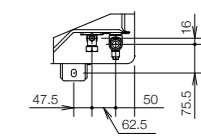

Unit: mm

24-hour nanoe™ X Air Purification*

While the general filters in air purifiers are effective against airborne bacteria and viruses, nanoe™ X also works to inhibit longer-living, adhered bacteria and viruses. As well as this, the Panasonic Comfort Cloud and WLAN smart adaptor (CZ-CAPWFC1) gives you access to your air conditioner anywhere, anytime, so you can turn nanoe™ X on even while you're out and enjoy 24-hour quality air.



Glass surface
Virus lifespan up to 4 days**

Wood
Virus lifespan up to 2 days**

Adhered Viruses
Last up to 2-7 days**

*Unit must be constantly turned on and operating in the air purification mode - nanoe™ X.
** <https://www.businessinsider.com/coronavirus-lifespan-on-surfaces-graphic-2020-3>

24-hour nanoe™ X air Purification, anywhere, anytime

Actively purifies your air and inhibits pollutants all day long

Get 24 hr Quality Air for you and your loved ones by turning nanoe™ X on using Panasonic Comfort Cloud even when you're out. nanoe™ X functions in both cooling and heating modes and is maintenance-free, helping you keep your costs down with cleaner air.

- nanoe™ X functions in cooling as well as fan mode after business hours.
- Cleans indoor air even when the space is not in use.
- No need to consume excessive electricity to clean the air.



Please refer to the nanoe™ X website.

Business Hours

nanoe ON, Cooling ON (Cooling Mode)

After Business Hours

nanoe ON, Cooling OFF (Fan Mode)

Only at 15W*/Hour
Low energy consumption with fan mode 15W* per hour for a single unit.

nanoe™ X cleans indoor air while maintaining a comfortable temperature when people are present.

After business hours, nanoe™ X keeps cleaning indoor air in fan mode.

*In case of using 2.2 kW-7.3 kW 4 way cassette models with fan tap L, flap position 5, standard panel. Energy consumption may vary depending on models.



nanoe™ X device evolution

	nanoe™	nanoe™ X Generator Mark 1	nanoe™ X Generator Mark 2	nanoe™ X Generator Mark 3	Differences in discharge systems ↓ Changed from 4-point discharge to circular discharge ↓
Hydroxyl radicals	 0.48 Trillion* hydroxyl radicals/sec	 4.8 Trillion* hydroxyl radicals/sec	 9.6 Trillion* hydroxyl radicals/sec	 48 Trillion* hydroxyl radicals/sec	
Device status		 Electrostatic atomisation Multi-leader discharge	 Electrostatic atomisation Multi-leader discharge	 Electrostatic atomisation Circular discharge	

* Measured using the ESR (Electron Spin Resonance) method (amount of hydroxyl radicals immediately after release from the generator). (Source: Panasonic internal research)

nanoe™ X technology inhibits novel coronavirus

Our nanoe™ X technology has shown to suppress the activity of viruses & bacteria. Enjoy cleaner and quality air at home. Stay safer indoors with nanoe™ X.

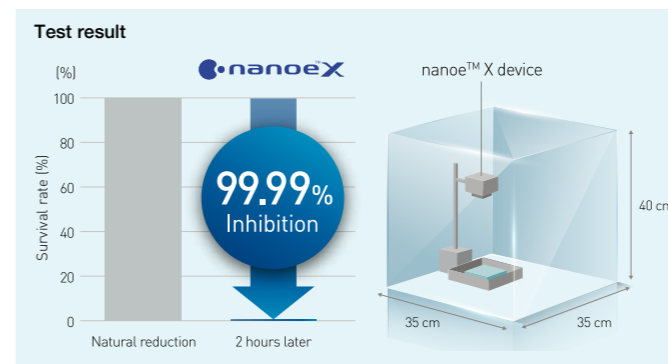

Overview

The objective of this test was to determine if nanoe™ X inhibit the activity of the SARS-CoV-2 virus. Gauze saturated with SARS-CoV-2 virus solution was exposed to a generator of nanoe™ X from a distance of 15 cm in a 45-liter box for 2 hours. Over 99.99%* of the activity of the SARS-CoV-2 virus was inhibited.

Device type: 10 x nanoe™ X (Mark 1)
Subject: Novel coronavirus (SARS-CoV-2)
Test Institute: TEXCELL (France) Test duration: 2 hours

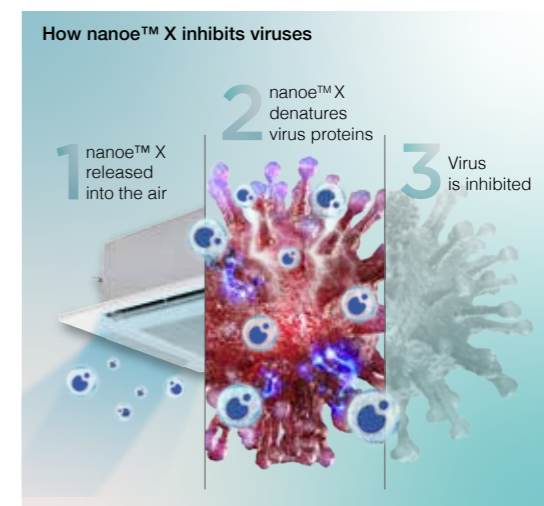

Notes: 1) The virus infectious titer was measured and used to calculate the inhibition rate. 2) This verification was designed to generate basic research data on the effects of nanoe™ X on the novel coronavirus in laboratory conditions. It was not designed to evaluate product performance.

nanoe™ X Mark 3 achieves virus inhibition in a larger space in a shorter time

Mark 3 (100 x) Device: 4-Way Cassette Large-Space Test for Adherent Virus (Bacteriophage)
In a large space of 139 m³ (56 m²), a 98.81% inhibition rate was achieved in 4 hours.

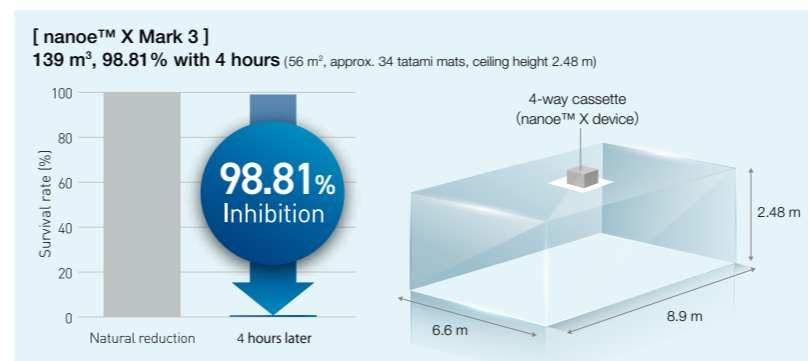

Please refer to the nanoe™ X website for the Mark 3 information.

Device type: nanoe™ X Generator Mark 3
Subject: Adhesive virus (coliphage)
Indoor unit: 4-way cassette
Test Institute: SGS Inc
Test duration: 4 hours
Report No.: SHES210901902584

Smart comfort with CONEX

CONEX goes beyond simple remote control to combine sophistication with simplicity, offering IoT integration that connects directly to a variety of apps for next-generation solutions.

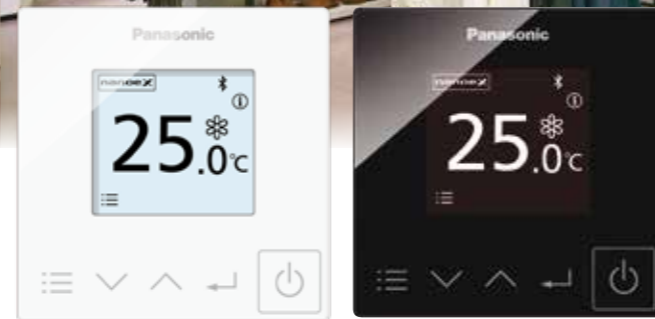

(CZ-RTC6W/CZ-RTC6WBL)

(CZ-RTC6/CZ-RTC6BL)

CONEX

Simple and sophisticated design in-and-out

User friendly interface with stylish design measuring just 86 x 86 mm, CONEX is an extremely compact remote controller which perfectly matches with all kinds of modern building.

Easy control and access for end users and installers with just one remote

User-friendly day-to-day operation for end users and simplified set up for installers.



A next-generation remote control solution optimised for usability

H&C Control App
End user | Installer

- Easy setting of timers and scheduling as well as monitoring power consumption.
- Fine tune the equipment to the environment.



Download on the App Store



GET IT ON Google Play

Scan QR code to download free Panasonic H&C Control App

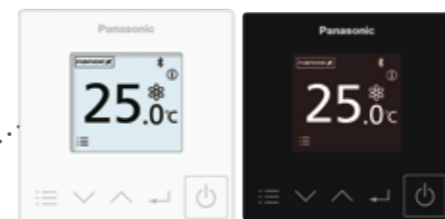

(CZ-RTC6WBL/CZ-RTC6BL)



True-comfort for end user and installer – H&C Control App

H&C Control App makes complex initial set-up visually touch and feel easy and respond swiftly to clients' requests via Bluetooth using a smartphone or tablet.



Advantages

Comfort day-to-day operations

It's now simpler than ever for end users to further customize settings to meet their needs and perform operations including basic settings.

Intuitive operation for easy configuration

Simplifies initial controller configuration as well as access to comprehensive settings including weekly timers and maintenance.

Straightforward suggestions to clients

Share a single screen with your customer and together tailor everything to meet their needs, from basic setup to weekly timers, all in real time.

Quicker configuration for multiple controllers

Save time and copy templates for weekly timers and settings to multiple remote controllers.



FSV Indoor Units Range

Wide choice of models depending on the indoor requirements

Class	22	28	36	45	56	60	73	90
Capacity	Cooling/Heating	Cooling/Heating	Cooling/Heating	Cooling/Heating	Cooling/Heating	Cooling/Heating	Cooling/Heating	Cooling/Heating
Type	2.2/2.5 7,500/8,500	2.8/3.2 9,600/10,900	3.6/4.2 12,300/14,300	4.5/5.0 15,400/17,100	5.6/6.3 19,100/21,500	6.0/7.1 20,500/24,200	7.3/8.0 24,900/27,300	9.0/10.0 30,700/34,100
nanoeX Generator Mark3 F3 type ECONAVI Mid Static Adaptive Ducted	NEW S-22MF3E5AN	NEW S-28MF3E5AN	NEW S-36MF3E5AN	NEW S-45MF3E5AN	NEW S-56MF3E5AN	NEW S-60MF3E5AN	NEW S-73MF3E5AN	NEW S-90MF3E5AN
M1 type ECONAVI Slim Low Static Ducted	S-22MM1E5A	S-28MM1E5A	S-36MM1E5A	S-45MM1E5A	S-56MM1E5A			
Z1 type ECONAVI Slim Low Static Ducted Twenty Series	S-22MZ1H4A	S-28MZ1H4A	S-36MZ1H4A	S-45MZ1H4A	S-56MZ1H4A	S-60MZ1H4A	S-73MZ1H4A	
E2 type High Static Ducted / Energy Saving High-Fresh Air Ducted								
H1 type High Fresh Air Ducted								
K2 type ECONAVI Wall Mounted	S-22MK2E5A	S-28MK2E5A	S-36MK2E5A	S-45MK2E5A	S-56MK2E5A		S-73MK2E5A	
nanoeX Generator Mark3 U2 type ECONAVI ** 4-Way Cassette Panel No. CZ-KPU3H Panel No. CZ-KPU3A	NEW S-22MU2E5BN	NEW S-28MU2E5BN	NEW S-36MU2E5BN	NEW S-45MU2E5BN	NEW S-56MU2E5BN	NEW S-60MU2E5BN	NEW S-73MU2E5BN	NEW S-90MU2E5BN
nanoeX Generator Mark3 Y3 type ECONAVI 4-Way Mini Cassette Panel No. CZ-KPY4	S-22MY3E	S-28MY3E	S-36MY3E	S-45MY3E	S-56MY3E			
L1 type 2-Way Cassette Panel No. CZ-02KPL2 Panel No. CZ-03KPL2 (Only for S-73ML1E5)	S-22ML1E5	S-28ML1E5	S-36ML1E5	S-45ML1E5	S-56ML1E5		S-73ML1E5	
D1 type 1-Way Cassette Panel No. CZ-KPD2		S-28MD1E5	S-36MD1E5	S-45MD1E5	S-56MD1E5		S-73MD1E5	
T2 type ECONAVI Ceiling			S-36MT2E5A	S-45MT2E5A	S-56MT2E5A		S-73MT2E5A	
P1 type Floor Standing	S-22MP1E5	S-28MP1E5	S-36MP1E5	S-45MP1E5	S-56MP1E5		S-71MP1E5	
R1 type Concealed Floor Standing	S-22MR1E5	S-28MR1E5	S-36MR1E5	S-45MR1E5	S-56MR1E5		S-71MR1E5	

* High fresh air system is not allowed for 18kW model.
** Only for CZ-KPU3A

106	112	140	160	180	224	280	Wireless remote control	Functions
Cooling/Heating	Cooling/Heating	Cooling/Heating	Cooling/Heating	Cooling/Heating	Cooling/Heating	Cooling/Heating	Type with built-in sensor	Type with separately installed sensor
10.6/11.4 36,200/38,900	11.02/12.5 38,200/42,700	14.0/16.0 47,800/54,600	16.0/18.0 54,600/61,400	18.0/20.0 61,400/68,200	22.4/25.0 76,400/85,300	28.0/31.5 95,500/107,500		
	NEW S-112MF3E5AN	NEW S-140MF3E5AN	NEW S-160MF3E5AN					self-diagnosis Auto fan Auto restart Drain pump DC motor DRY mode
								self-diagnosis Auto fan Auto restart Drain pump DC motor DRY mode
								self-diagnosis Auto fan Auto restart DC motor DRY mode
				S-180ME2E5 *	High Fresh Air S-224ME2E5	High Fresh Air S-280ME2E5		self-diagnosis Auto fan Auto restart DC motor DRY mode
		High Fresh Air S-140MH1H5			High Fresh Air S-224MH1H5	High Fresh Air S-280MH1H5		self-diagnosis Auto fan Auto restart
S-106MK2E5A								self-diagnosis Auto fan Auto restart Air swing Drain pump DRY mode Auto flap
	NEW S-112MU2E5BN	NEW S-140MU2E5BN	NEW S-160MU2E5BN					self-diagnosis Auto fan Auto restart Air swing Drain pump DC motor DRY mode Auto flap
								self-diagnosis Auto fan Auto restart Air swing Drain pump DC motor DRY mode Auto flap
								self-diagnosis Auto fan Auto restart Air swing Drain pump DC motor DRY mode Auto flap
S-106MT2E5A		S-140MT2E5A						self-diagnosis Auto fan Auto restart Air swing DC motor DRY mode Auto flap
								self-diagnosis Auto fan Auto restart DRY mode
								self-diagnosis Auto fan Auto restart DRY mode

Self-diagnosis function
 Automatic fan operation
 DRY Dry mode
 Intelligent auto flap control
 Automatic restart function for power failure
 Air swing
 DP Built-in drain pump
 DC motor

NEW

F3 TYPE Mid Static Adaptive Ducted



nanoe™ X Generator Mark3



Please refer to the nanoe™ X website for the Mark 3 information.

Control all aspects of your environment with exceptional performance and quiet operation. Vertical installation flexibility offers the perfect solution when ceiling heights are restricted.



S-22MF3E5AN / S-28MF3E5AN / S-36MF3E5AN / S-45MF3E5AN / S-56MF3E5AN



S-60MF3E5AN / S-73MF3E5AN / S-90MF3E5AN



S-106MF3E5AN / S-140MF3E5AN / S-160MF3E5AN

Optional accessory

ECONAVI ECONAVI ready



CZ-RTC6W CZ-RTC6WBL CZ-RTC6WBLW



CZ-RTC6 CZ-RTC6BL CZ-RTC6BLW



CZ-CENSC1



CZ-RTC5B



CZ-RWS3 Remote controller



CZ-RWRC3 Receiver

Technical focus

- 4 installation possibilities with horizontal and vertical mounting and selectable rear or bottom air inlet
- DC fan motor for variable external static pressure control
- Industry-leading horizontal/vertical design with 250 mm height
- Powerful 150 Pa static pressure in a compact unit.
- Leading-class low sound levels from 20 dB(A)
- Improved drain pan suitable for both horizontal / vertical installation
- nanoe™ X : 100x for CAC (100 times more nanoe™ particle for wide commercial space)
- Possible to control discharge air temperature for accurate room temperature control.

Powerful 150 Pa external static pressure in an industry-leading horizontal/vertical installation design

Delivering static pressure up to 150 Pa external static pressure, the industry-leading horizontal/vertical design offers the power you need in a compact form factor.



Improved drain pan design

Drain pan is shared in both cases horizontal and vertical installation. No need to alternate anymore.



Superior Air Quality

Combined with the strong static pressure this model ensures pristine nanoe™ X air travels unaffected even through multiple duct shapes at lengths of 10 m, as well as making them ideal for use in larger spaces.

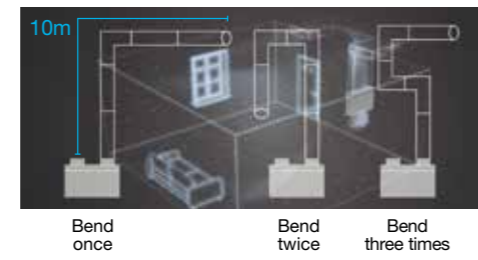

As the experiments demonstrate; even with a total ductwork length of up to 10 m, effectiveness of nanoe™ X is maintained.



Model Name		S-22MF3E5AN	S-28MF3E5AN	S-36MF3E5AN	S-45MF3E5AN	S-56MF3E5AN
Power source		220/230/240 V, 1 phase - 50/60 Hz				
Cooling capacity	kW	2.2	2.8	3.6	4.5	5.6
	BTU/h	7,500	9,600	12,300	15,400	19,100
Heating capacity	kW	2.5	3.2	4.2	5.0	6.3
	BTU/h	8,500	10,900	14,300	17,100	21,500
Power input	Cooling kW	0.06/0.06/0.06	0.06/0.06/0.06	0.06/0.06/0.06	0.06/0.06/0.06	0.089/0.089/0.089
	Heating kW	0.06/0.06/0.06	0.06/0.06/0.06	0.06/0.06/0.06	0.06/0.06/0.06	0.089/0.089/0.089
Running current	Cooling A	0.46/0.45/0.44	0.46/0.45/0.44	0.46/0.45/0.44	0.46/0.45/0.44	0.65/0.63/0.61
	Heating A	0.46/0.45/0.44	0.46/0.45/0.44	0.46/0.45/0.44	0.46/0.45/0.44	0.65/0.63/0.61
Fan motor	Type	Sirocco fan				
	Cooling m³/h	768/660/480	768/660/480	840/720/480	840/720/480	960/840/600
	Air flow rate (H/M/L) L/s	213/183/133	213/183/133	233/200/133	233/200/133	267/233/167
	Heating m³/h	840/720/480	840/720/480	840/720/480	840/720/480	960/840/600
	Air flow rate (H/M/L) L/s	233/200/133	233/200/133	233/200/133	233/200/133	267/233/167
	Output kW	0.107	0.107	0.107	0.107	0.107
External static pressure Pa		30 (10-150)	30 (10-150)	30 (10-150)	30 (10-150)	30 (10-150)
Sound power level (H/M/L) dB		54/51/43	54/51/43	54/51/43	54/51/43	58/55/47
Sound pressure sound (H/M/L) dB(A)		31/28/20	31/28/20	31/28/20	31/28/20	35/32/24
Dimensions H x W x D mm		250 x 800 x 730				
	Liquid mm (inches)	Ø6.35 (Ø1/4)	Ø6.35 (Ø1/4)	Ø6.35 (Ø1/4)	Ø6.35 (Ø1/4)	Ø6.35 (Ø1/4)
Pipe connections Gas mm (inches)		Ø12.7 (Ø1/2)	Ø12.7 (Ø1/2)	Ø12.7 (Ø1/2)	Ø12.7 (Ø1/2)	Ø12.7 (Ø1/2)
	Drain piping	VP-20	VP-20	VP-20	VP-20	VP-20
Net weight kg		26	26	26	26	26

Built-in Drain pump (DC motor pump)

Space saving height of 250 mm for all models

250 mm standardised height provides easy and uniform installation for models with different capacities, especially when ceiling heights are restricted.

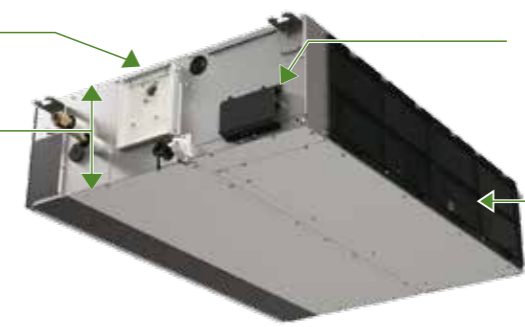

External electrical equipment box makes maintenance easy

Built-in filter

Selectable air inlet position

A removable panel allows air inlet position to be adjusted to enable rear or bottom entry, depending on ductwork installation.

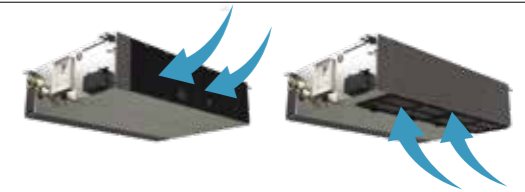

System example

An inspection port (450 mm x 450 mm or larger) is required at the lower side of the indoor unit body.

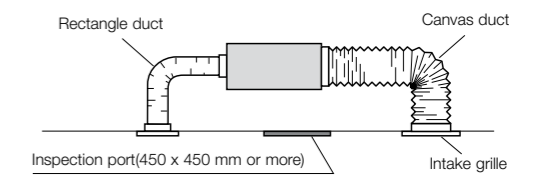

More powerful drain pump

Using a high-lift built-in drain pump, drain piping can be elevated up to 690 mm from the base of the unit.

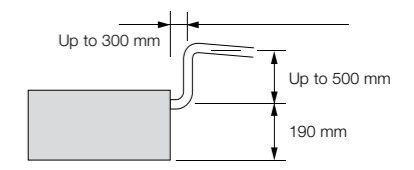

S-60MF3E5AN	S-73MF3E5AN	S-90MF3E5AN	S-112MF3E5AN	S-140MF3E5AN	S-160MF3E5AN
220/230/240 V, 1 phase - 50/60 Hz					
6.0	7.3	9.0	11.2	14.0	16.0
20,500	24,900	30,700	38,200	47,800	54,600
7.1	8.0	10.0	12.5	16.0	18.0
24,200	27,300	34,100	42,700	54,600	61,400
0.079/0.079/0.079	0.079/0.079/0.079	0.136/0.136/0.136	0.265/0.265/0.265	0.265/0.265/0.265	0.330/0.330/0.330
0.079/0.079/0.079	0.079/0.079/0.079	0.136/0.136/0.136	0.265/0.265/0.265	0.265/0.265/0.265	0.330/0.330/0.330
0.53/0.52/0.51	0.53/0.52/0.51	0.92/0.90/0.88	1.80/1.76/1.72	1.80/1.76/1.72	2.22/2.14/2.09
0.53/0.52/0.51	0.53/0.52/0.51	0.92/0.90/0.88	1.80/1.76/1.72	1.80/1.76/1.72	2.22/2.14/2.09
Sirocco fan	Sirocco fan	Sirocco fan	Sirocco fan	Sirocco fan	Sirocco fan
1,260/1,080/900	1,260/1,080/900	1,500/1,380/960	2,220/1,920/1,560	2,220/1,920/1,560	2,400/2,040/1,680
350/300/250	350/300/250	417/383/267	617/533/433	617/533/433	667/567/467
1,260/1,080/900	1,260/1,080/900	1,500/1,380/960	2,220/1,920/1,560	2,220/1,920/1,560	2,400/2,040/1,680
350/300/250	350/300/250	417/383/267	617/533/433	617/533/433	667/567/467
0.165	0.165	0.165	0.259	0.259	0.259
30 (10-150)	30 (10-150)	40 (10-150)	50 (10-150)	50 (10-150)	50 (10-150)
54/51/46	54/51/46	58/56/48	64/59/55	64/59/55	66/60/56
31/28/23	31/28/23	35/33/25	41/36/32	41/36/32	43/37/33
250 x 1,000 x 730	250 x 1,000 x 730	250 x 1,000 x 730	250 x 1,400 x 730	250 x 1,400 x 730	250 x 1,400 x 730
Ø6.35 (Ø1/4)	Ø6.35 (Ø1/4)	Ø6.35 (Ø1/4)	Ø9.52 (Ø3/8)	Ø9.52 (Ø3/8)	Ø9.52 (Ø3/8)
Ø12.7 (Ø1/2)	Ø12.7 (Ø1/2)	Ø12.7 (Ø1/2)	Ø15.88 (Ø5/8)	Ø15.88 (Ø5/8)	Ø15.88 (Ø5/8)
VP-20	VP-20	VP-20	VP-20	VP-20	VP-20
31	31	31	40	40	40

GLOBAL REMARKS

Rated conditions: Cooling
Indoor air temperature 27°C DB / 19°C WB

Outdoor air temperature 35°C DB / 24°C WB

Rated conditions: Heating
Indoor air temperature 20°C DB

Outdoor air temperature 7°C DB / 6°C WB

Specifications are subject to change without notice.

M1 TYPE Slim Low Static Ducted



Concealed duct

Optional accessory



S-22MM1E5A
S-28MM1E5A
S-36MM1E5A
S-45MM1E5A
S-56MM1E5A



Z1 TYPE Slim Low Static Ducted Twenty Series



Concealed duct

Optional accessory



S-22MZ1H4A / S-28MZ1H4A / S-36MZ1H4A
S-45MZ1H4A / S-56MZ1H4A / S-60MZ1H4A



Technical focus

- Ultra-slim profile: 200 mm for all models
- DC fan motor greatly reduces power consumption
- Ideal for hotel application with very narrow false ceilings
- Easy maintenance and service by external electrical box
- 40 Pa static pressure enables ductwork to be fitted.
- Includes drain pump
- Includes built in filter

Ultra-slim profile for all models

200 mm height for all models allows installation in very narrow ceilings.



Drain pump with increased power

Using the built-in high-lift drain pump, the drain piping rise height can be increased to 653 mm from the lower surface of the body.

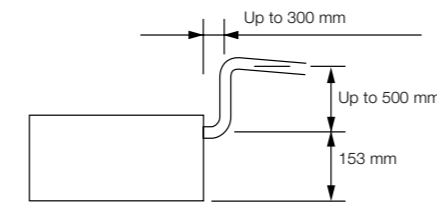

Model Name		S-22MM1E5A	S-28MM1E5A	S-36MM1E5A	S-45MM1E5A	S-56MM1E5A	
Power source		220/230/240 V, 1 phase - 50 / 60 Hz					
Cooling capacity	kW	2.2	2.8	3.6	4.5	5.6	
	BTU/h	7,500	9,600	12,300	15,400	19,100	
Heating capacity	kW	2.5	3.2	4.2	5.0	6.3	
	BTU/h	8,500	10,900	14,300	17,100	21,500	
Power input	Cooling kW	0.036/0.036/0.036	0.040/0.040/0.040	0.042/0.042/0.042	0.049/0.049/0.049	0.064/0.064/0.064	
	Heating kW	0.026/0.026/0.026	0.030/0.030/0.030	0.032/0.032/0.032	0.039/0.039/0.039	0.054/0.054/0.054	
Running current	Cooling A	0.26/0.26/0.26	0.30/0.30/0.30	0.31/0.31/0.31	0.37/0.37/0.37	0.48/0.48/0.48	
	Heating A	0.23/0.23/0.23	0.27/0.27/0.27	0.28/0.28/0.28	0.34/0.34/0.34	0.45/0.45/0.45	
Fan	Type	Sirocco fan					
	Air flow rate (H/M/L)	m³/h	480/420/360	510/450/390	540/480/420	630/570/480	750/690/600
		L/s	133/117/100	142/125/108	150/133/117	175/158/133	208/192/167
	Motor output	kW 0.06					
	External static pressure	Pa 10 (30)*					
Sound power level (H/M/L)	dB	43/42/40	45/44/42	47/45/43	49/47/45	50/48/46	
Sound pressure level (H/M/L)	dB(A)	28/27/25 (30/29/27)*	30/29/27 (32/31/29)*	32/30/28 (34/32/30)*	34/32/30 (36/34/32)*	35/33/31 (37/35/32)*	
Dimensions	H x W x D	mm 200 x 750 x 640					
Pipe connections	Liquid	mm (inches) Ø6.35 (Ø1/4)					
	Gas	mm (inches) Ø12.7 (Ø1/2)					
	Drain piping	VP-20					
Net weight	kg	19					

Specifications are subject to change without notice. * With booster cable.

Global remarks	Rated conditions:	
	Cooling	Heating
	Indoor air temperature	27°C DB / 19°C WB
Outdoor air temperature	35°C DB / 24°C WB	7°C DB / 6°C WB

Technical focus

- Ultra-slim profile: 200 mm for all models
- DC fan motor greatly reduces power consumption
- Ideal for hotel application with very narrow false ceilings
- Easy maintenance and service by external electrical box
- 29 Pa static pressure enables ductwork to be fitted.
- Drain pump (optional)

Ultra-slim profile for all models

200 mm height for all models allows installation in very narrow ceilings.



Drain pump with increased power (optional)

Using the optional high-lift drainage pump, the drain piping rise height can be increased up to 1,000 mm from the drain pipe port.



Model Name		S-22MZ1H4A	S-28MZ1H4A	S-36MZ1H4A	S-45MZ1H4A	S-56MZ1H4A	S-60MZ1H4A	S-73MZ1H4A	
Power source		220/230/240 V, 1 phase - 50 / 60 Hz							
Cooling capacity	kW	2.2	2.8	3.6	4.5	5.6	6.0	7.3	
	BTU/h	7,500	9,500	12,200	15,300	19,100	20,500	24,900	
Heating capacity	kW	2.5	3.2	4.2	5.1	6.4	7.1	8.0	
	BTU/h	8,500	10,900	14,300	17,400	21,800	24,200	27,300	
Power input	Cooling kW	0.075/0.075/0.075	0.080/0.080/0.080	0.085/0.085/0.085	0.095/0.095/0.095	0.100/0.100/0.100	0.100/0.100/0.100	0.125/0.125/0.125	
	Heating kW	0.075/0.075/0.075	0.080/0.080/0.080	0.085/0.085/0.085	0.095/0.095/0.095	0.100/0.100/0.100	0.100/0.100/0.100	0.125/0.125/0.125	
Running current	Cooling A	0.50/0.47/0.45	0.55/0.52/0.50	0.60/0.57/0.55	0.70/0.68/0.65	0.75/0.72/0.70	0.75/0.72/0.70	0.80/0.78/0.75	
	Heating A	0.50/0.47/0.45	0.55/0.52/0.50	0.60/0.57/0.55	0.70/0.68/0.65	0.75/0.72/0.70	0.75/0.72/0.70	0.80/0.78/0.75	
Fan	Type	Sirocco fan							
	Air flow rate (H/M/L)	m³/h	480/420/360	600/540/420	600/540/420	690/630/510	720/660/540	870/750/630	1,080/840/660
		L/s	133/117/100	167/150/117	167/150/117	192/175/142	200/183/150	242/208/175	300/233/183
	Motor output	kW 0.06							
	External static pressure	Pa 10-30							
Sound power level (H/M/L)	dB	50/49/47	52/51/49	54/52/50	56/54/52	57/55/53	60/57/55	62/60/58	
Sound pressure level (H/M/L)	dB(A)	28/27/25	30/29/27	32/30/28	34/32/30	35/33/31	38/35/33	40/38/36	
Dimensions	H x W x D	mm 200x830x500							
Pipe connections	Liquid	mm (inches) Ø6.35 (Ø1/4)							
	Gas	mm (inches) Ø12.7 (Ø1/2)							
	Drain piping	VP-25							
Net weight	kg	17							

Specifications are subject to change without notice.

Global remarks	Rated conditions:	
	Cooling	Heating
	Indoor air temperature	27°C DB / 19°C WB
Outdoor air temperature	35°C DB / 24°C WB	7°C DB / 6°C WB

E2 TYPE High Static Ducted



Concealed duct / Air conditioning mode Optional accessory



S-180ME2E5
S-224ME2E5
S-280ME2E5



CZ-RTC6W CZ-RTC6WBL CZ-RTC6 CZ-RTC6BL CZ-RTC5B CZ-RWS3 Remote controller CZ-RWRC3 Receiver

E2 TYPE Energy Saving High Fresh Air Ducted



Concealed duct high-static pressure Optional accessory



S-224ME2E5
S-280ME2E5



CZ-RTC6W CZ-RTC6WBL CZ-RTC6 CZ-RTC6BL CZ-RTC5B CZ-RWS3 Remote controller CZ-RWRC3 Receiver

Technical focus

- Design flexibility thanks to high static pressure and large air volume
- DC motor equipped
- Power input 45% less (compared to E1 type)
- Discharge air temperature control to reduce cold drafts during heating operation
- Configurable air temperature control
- Available Fresh Air Intake mode (See page 29)

3-step static pressure set up

You can select between the three Static Pressure modes of 270 Pa/140 Pa/60 (72*) Pa for extra installation flexibility.



Max. 270 Pa static pressure setting

A maximum static pressure setting of a high 270 Pa enables the use of long ducts for installation in a wide range of spaces. Ideal for large-scale offices, restaurants and other facilities.

Sensible cooling 5-10% improved

New heat exchanger with ϕ 7 mm pipe that increases the heat transfer surface to improve sensible cooling (5-10% improvement)

Discharge air temperature control

- Equipped with 4 sensors (Intake/ Discharge)
- Able to control discharge air temperature for accurate room temperature control.
- Possible to reduce cold drafts during heating operation.

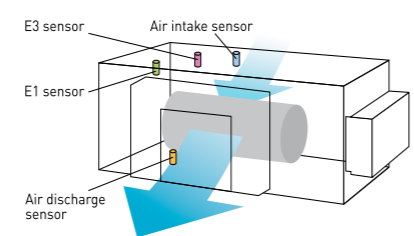

Model Name		S-180ME2E5	S-224ME2E5	S-280ME2E5	
Power source		220/230/240V, 1 Phase-50 Hz, 220/230V, 1 Phase-60Hz			
Cooling capacity	kW	18.0	22.4	28.0	
	BTU/h	61,400	76,400	95,500	
Heating capacity	kW	20.0	25.0	31.5	
	BTU/h	68,200	85,300	107,500	
Power input	Cooling kW	0.400	0.440	0.715	
	Heating kW	0.400	0.440	0.715	
Running current	Cooling A	2.40 / 2.30 / 2.20	2.55 / 2.45 / 2.35	3.95 / 3.85 / 3.70	
	Heating A	2.40 / 2.30 / 2.20	2.55 / 2.45 / 2.35	3.95 / 3.85 / 3.70	
Fan	Type	Sirocco fan			
	Air flow rate (H/M/L)	2,940 / 2,640 / 2,340	3,360 / 3,060 / 2,640	4,320 / 3,780 / 3,180	
		L/s	817 / 733 / 650	933 / 850 / 733	1,200 / 1,050 / 883
	Motor output	0.560 x 2			
	External static pressure	Pa	140 (60/270)	140 (60/270)	140 (72/270)
Sound power level (H/M/L)	dB	76 / 74 / 72	77 / 75 / 73	81 / 79 / 75	
Sound pressure level (H/M/L)	dB(A)	44 / 42 / 40	45 / 43 / 41	49 / 47 / 43	
Dimensions	H x W x D	479 x 1,453 x 1,205			
		mm	479 x 1,453 x 1,205	479 x 1,453 x 1,205	
Pipe connections	Liquid	mm (inches)	Ø9.52 (3/8)	Ø9.52 (3/8)	
	Gas	mm (inches)	Ø19.05 (3/4)	Ø19.05 (3/4)	
Drain piping			VP-25	VP-25	
			VP-25	VP-25	
Net weight	kg	102	102	106	

Global remarks	Rated conditions:	
	Cooling	Heating
	Indoor air temperature	27°C DB / 19°C WB
Outdoor air temperature	35°C DB / 24°C WB	7°C DB / 6°C WB

Technical focus

- 100% fresh air intake for ventilation purpose
- Design flexibility with high static pressure and large air volume
- DC motor equipped
- Power input 45% less (compared to H1 type)
- Discharge air temperature control to reduce cold drafts during heating operation
- Configurable air temperature control

High fresh system

High Fresh System enables delivery of fresh outside air at almost the same temperature and humidity as indoor air without putting a burden on air conditioning.

* Capable of treating outdoor air only. Indoor air conditioner units are required to adjust indoor air temperature.

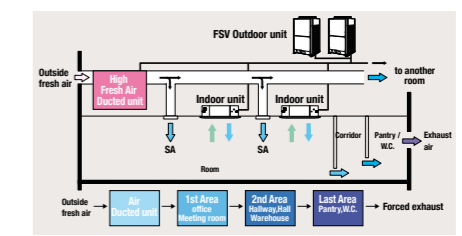

Mix operation unit with standard indoor units

Possible to combine High Fresh Air ducted indoor unit and standard air ducted indoor units. When other indoor units are connected in same circuit, keep following capacity ratio. E2 type/Outdoor unit < 30%, and Total of indoors(incl. E2)/outdoor < 100%

Discharge air temperature control

- Equipped with 4 sensors (Intake/ Discharge)
- Able to control discharge air temperature for accurate room temperature control.
- Possible to reduce cold drafts during heating operation.

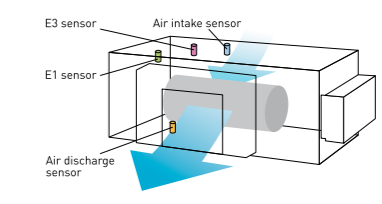

Model Name		S-224ME2E5	S-280ME2E5	
Power source		220/230/240V, 1 Phase-50 Hz, 220/230V, 1 Phase-60Hz		
Cooling capacity	kW	22.4	28.0	
	BTU/h	76,400	95,500	
Heating capacity	kW	21.2	26.5	
	BTU/h	72,300	90,400	
Power input	Cooling kW	0.290	0.350	
	Heating kW	0.290	0.350	
Running current	Cooling A	1.90/1.85/1.80	2.30/2.20/2.10	
	Heating A	1.90/1.85/1.80	2.30/2.20/2.10	
Fan	Type	Sirocco fan		
	Air flow rate	m³/h	1,700	2,100
		L/s	472	583
	Motor output	0.560 x 2		
	External static pressure	Pa	200	200
Sound power level	dB	75	76	
Sound pressure level	dB(A)	43	44	
Dimensions	H x W x D	479 x 1,453 x 1,205		
		mm	479 x 1,453 x 1,205	
Pipe connections	Liquid	mm (inches)	Ø9.52 (Ø3/8)	
	Gas	mm (inches)	Ø19.05 (Ø3/4)	
Drain piping			VP-25	
			VP-25	
Net weight	kg	102	106	

Global remarks	Rated conditions:	
	Cooling	Heating
Outdoor air temperature	33°C DB / 28°C WB	0°C DB / -2.9°C WB

H1 TYPE High-Fresh Air Ducted Concealed duct

High static and large airflow ducted for exceptional installation flexibility.



Technical focus

- 100% fresh Air intake for ventilation purpose
- Design flexibility thanks to high static pressure and large air volume
- Discharge air temperature control to reduce cold drafts during heating operation
- Configurable air temperature control

High Fresh System

High Fresh system enables delivery of fresh outside air at almost the same temperature and humidity as indoor air without putting a burden on air conditioning.
 * Capable of treating outdoor air only. Indoor air conditioner units are required to adjust indoor air temperature.

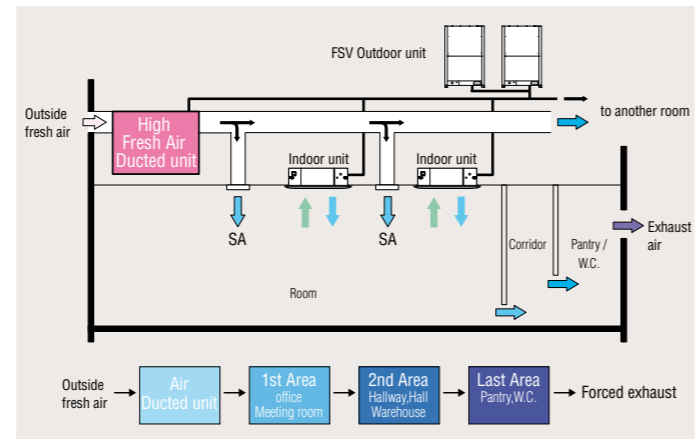

Mix operation unit with standard indoor units

Possible to combine High Fresh Air ducted indoor unit and standard air ducted indoor units.

When other indoor units are connected in same circuit, keep following capacity ratio.
 H1 type/Outdoor unit < 30%, and Total of indoors(incl. H1)/outdoor < 100%

Remark For High Static Ducted Series

Model	Operation	Rap valve kit CZ-P160RVK2	3way control PCB CZ-CAPE2	3way valve kit CZ-P160HR3	Distribution Joint kit <2pipes> CZ-P160BK2 for 22.4kW unit or less CZ-P680BK2 for more than 22.4kW	Distribution Joint kit <3pipes> CZ-P224BH2 for 22.4kW unit CZ-P680BH2 for 28.0kW unit
H1 Type High-Fresh Air Ducted	Cooling Only	-	-	-	-	-
	Cool or Heat	2pcs	-	-	2pcs	-
	Heat Recovery	-	-	2pcs	1pc	1pc

Model Name		S-140MH1H5	S-224MH1H5	S-280MH1H5
Power source		220/230/240 V, 1 phase - 50 Hz		
Cooling capacity	kW	14.0	22.4	28.0
	BTU/h	47,800	76,400	95,500
Heating capacity	kW	13.2	21.2	26.5
	BTU/h	45,000	72,300	90,400
Power input	Cooling kW	0.430/0.430/0.430	0.670/0.670/0.670	0.730/0.730/0.730
	Heating kW	0.430/0.430/0.430	0.670/0.670/0.670	0.730/0.730/0.730
Running current	Cooling A	2.0/1.9/1.9	3.2/3.1/3.0	3.6/3.4/3.3
	Heating A	2.0/1.9/1.9	3.2/3.1/3.0	3.6/3.4/3.3
Fan		Sirocco fan		
Air flow rate	m ³ /h	1,560	1,800	2,100
	L/s	433	500	583
Motor output		0.3	0.38	0.38
Sound power level (H/M/L)		75/76/76	78/79/79	79/80/80
Sound pressure level (H/M/L)		43/44/44	46/47/47	47/48/48
Dimensions	H x W x D mm	420 x 1,065 x 620	479 x 1,428 x 1,230	479 x 1,428 x 1,230
	Liquid mm (inches)	Ø9.52 (Ø3/8)	Ø12.7 (Ø1/2)	Ø12.7 (Ø1/2)
Pipe connections	Gas mm (inches)	Ø15.88 (Ø5/8)	Ø25.4 (Ø1)	Ø25.4 (Ø1)
	Drain piping	VP-25	VP-25	VP-25
Net weight		50	110	110

GLOBAL REMARKS	Rated conditions:		Specifications are subject to change without notice.	
	Cooling	Heating	Cooling	Heating
	33°C DB / 28°C WB	0°C DB / -2.9°C WB		

H1TYPE HIGH-FRESH AIR DUCTED Dimensions

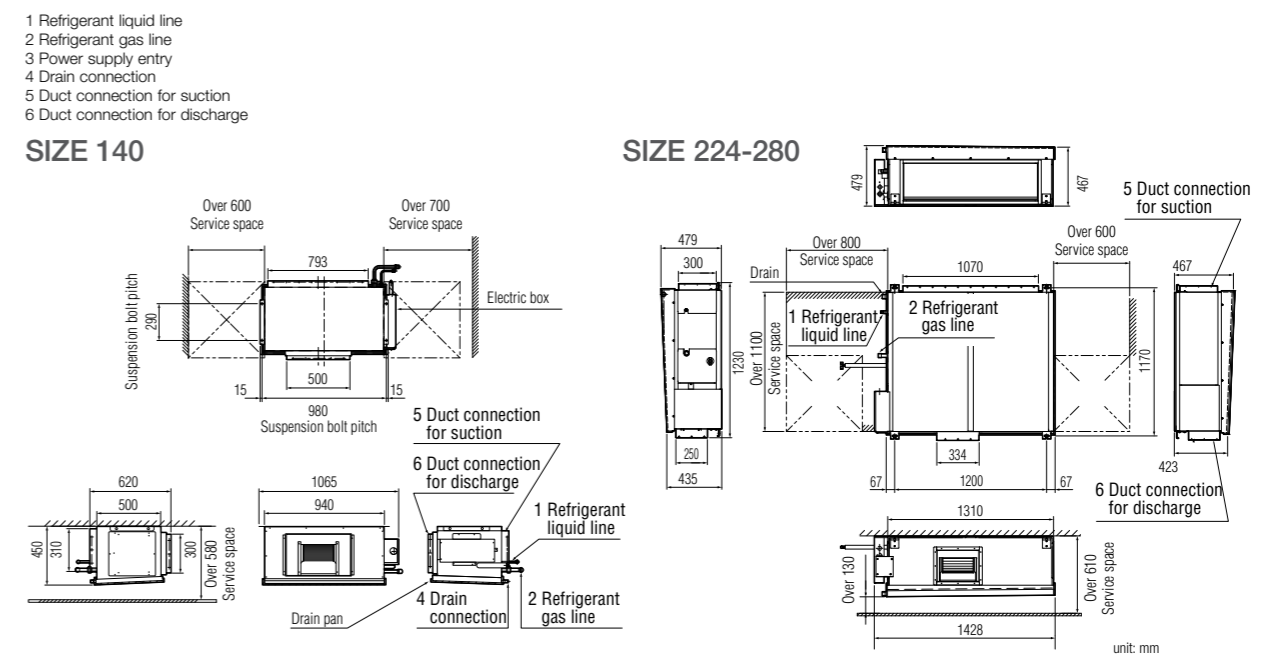

K2 TYPE Wall Mounted



Technical focus

- Closed discharge port when not in use
- Lighter and smaller units make installation easy
- Quiet operation
- Smooth and durable design
- Piping outlet in six directions
- Washable front panel
- Air distribution is automatically altered depending on the operational mode of the unit

Noise reducing external valve kit

To reduce noise level of expansion valve.
(Optional accessory)



CZ-P56SVK2 (for 22 - 56 type)
CZ-P160SVK2 (for 73* - 106 type)
*When the pipe diameter is (Liquid) Ø6.35- (Gas) Ø12.7, please use CZ-P56SVK2.

Closed discharge port

When the unit is turned off, the flap closes completely to prevent entry of dust into the unit and to keep the equipment clean.

Model Name	S-22MK2E5A	S-28MK2E5A	S-36MK2E5A	S-45MK2E5A		
Power source	220/230/240 V, 1 phase - 50 / 60 Hz					
Cooling capacity	kW	2.2	2.8	3.6	4.5	
	BTU/h	7,500	9,600	12,300	15,400	
Heating capacity	kW	2.50	3.20	4.20	5.0	
	BTU/h	8,500	10,900	14,300	17,100	
Power input	Cooling kW	0.025/0.025/0.025	0.025/0.025/0.025	0.030/0.030/0.030	0.030/0.030/0.030	
	Heating kW	0.025/0.025/0.025	0.025/0.025/0.025	0.030/0.030/0.030	0.030/0.030/0.030	
Running current	Cooling A	0.21	0.23	0.25	0.33/0.32/0.31	
	Heating A	0.21	0.23	0.25	0.33/0.32/0.31	
Fan	Type	Cross-flow fan				
	Air flow rate (H/M/L)	m³/h	540/450/390	570/498/390	654/540/390	870/750/600
		L/s	150/125/108	158/138/108	182/150/108	242/208/167
	Motor output	kW	0.03	0.03	0.03	0.054
Sound power level (H/M/L)	dB	51/48/44	52/49/44	55/51/44	53/50/48	
Sound pressure level (H/M/L)	dB(A)	36/33/29	37/34/29	40/36/29	38/35/33	
Dimensions	H x W x D	mm 290 x 870 x 214				
	Liquid	mm (inches)	Ø6.35 (Ø1/4)			
	Gas	mm (inches)	Ø12.7 (Ø1/2)			
Pipe connections	Gas	mm (inches)	Ø12.7 (Ø1/2)			
	Drain piping	mm	Ø18			
Net weight	kg	9	9	9	13	

Global remarkszz	Rated conditions:	
	Cooling	Heating
	Indoor air temperature	27°C DB / 19°C WB
Outdoor air temperature	35°C DB / 24°C WB	7°C DB / 6°C WB

Specifications are subject to change without notice.

Compact indoor units make the installation easy

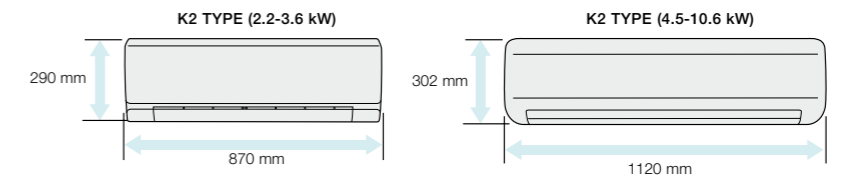

Quiet operation

Low operating noise level makes these units ideal for hotels and hospital applications.

Smooth and durable design

The smooth cover means these units match most modern interiors. Their compact size enables them to blend in, even in small spaces.

Piping outlet in six directions

Piping outlet is possible in the six directions of right, right rear, right bottom, left, left rear, left bottom, making installation easier.

Washable front panel

The indoor unit's front panel can be easily removed and washed for trouble-free maintenance.



Air distribution is automatically adjusted depending on the operational mode of the unit

Air outlet angle is automatically adjusted for cooling and heating operation.

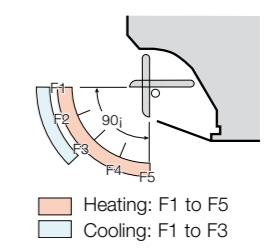

S-56MK2E5A	S-73MK2E5A	S-106MK2E5A
220/230/240 V, 1 phase - 50 / 60 Hz		
5.6	7.3	10.6
19,100	24,900	36,200
6.3	8.0	11.4
21,500	27,300	38,900
0.035/0.035/0.035	0.055/0.055/0.055	0.080/0.080/0.080
0.035/0.035/0.035	0.055/0.055/0.055	0.080/0.080/0.080
0.36/0.35/0.34	0.52/0.51/0.50	0.72/0.70/0.68
0.36/0.35/0.34	0.52/0.51/0.50	0.72/0.70/0.68
Cross-flow fan	Cross-flow fan	Cross-flow fan
960/840/720	1,170/1,020/840	1,290/1,110/900
267/233/200	325/283/233	358/308/250
0.054	0.054	0.054
55/52/50	62/59/55	64/61/57
40/37/35	47/44/40	49/46/42
302 x 1,120 x 236	302 x 1,120 x 236	302 x 1,120 x 236
Ø6.35 (Ø1/4)	Ø9.52 (Ø3/8)	Ø9.52 (Ø3/8)
Ø12.7 (Ø1/2)	Ø15.88 (Ø5/8)	Ø15.88 (Ø5/8)
Ø18	Ø18	Ø18
13	14	14

NEW
U2 TYPE 4-WAY Cassette
Semi concealed cassette

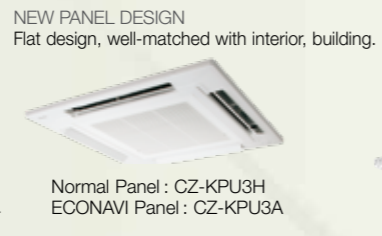
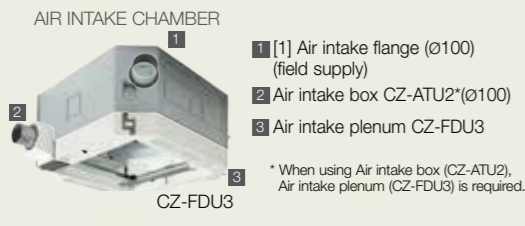

Optional accessory

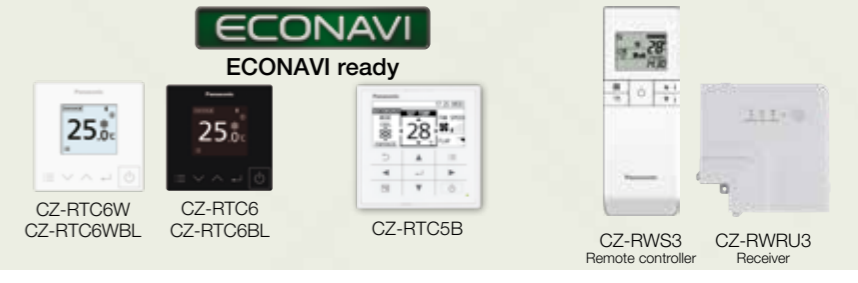

Technical focus

- New high performance turbo fan, new path system for heat exchanger
- Lower noise in slow fan operation
- Industry top light weight, easy piping
- Easy installation structure of the panel
- Econavi : Floor temperature and human sensor added. Activity amount detection and new circulator
- nanoe™X : 100x for CAC (100 times more nanoe™ particle for wide commercial space). Inside cleaning by 100x nanoe™ + dry control

Flat horizontal design

The horizontal design of 4-way cassette achieves an elegant designed panel. Its slim design allow to protrude 33.5 mm from the ceiling.

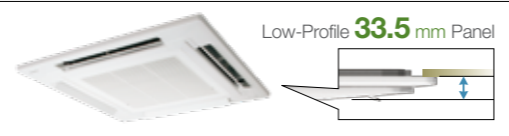

Drain pump of up to 850 mm from the ceiling surface

Built in drain pump allows flexible install and design options with up to 850 mm lift. Long horizontal piping is also possible.

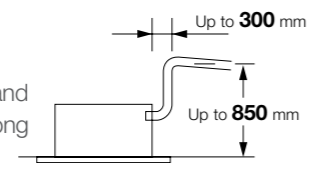

Easy to clean suction grille

Suction grille is able to make 90-degree turns.



360° wide & comfortable airflow

Comfort air flow control and proper energy use. Flexible Air Flow direction control by individual flap control:
-4 Flaps can be controlled individually (by standard wired remote controller*)
-Versatile air flow control to cover a wide variety of demands.

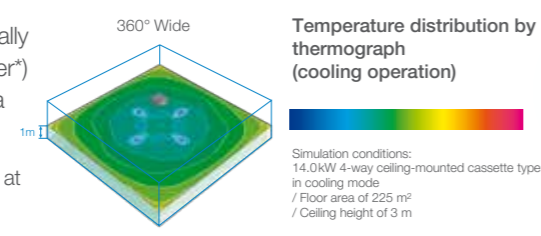

Ample airflow: 36 m³/min

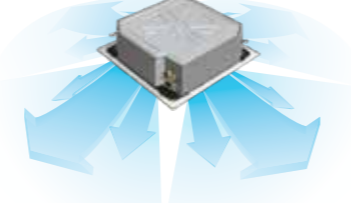

*Pre-setting is required for this function at System Test-run procedure

*Pre-setting is required for this function at System Test-run procedure

Model Name	S-22MU2E5BN	S-28MU2E5BN	S-36MU2E5BN	S-45MU2E5BN	S-56MU2E5BN		
Power source	220/230/240 V, 1 phase - 50Hz/60Hz						
Cooling capacity	kW	2.2	2.8	3.6	4.5	5.6	
	BTU/h	7,500	9,600	12,300	15,400	19,100	
Heating capacity	kW	2.5	3.2	4.2	5.0	6.3	
	BTU/h	8,500	10,900	14,300	17,100	21,500	
Power input	Cooling kW	0.020/0.020/0.020	0.020/0.020/0.020	0.020/0.020/0.020	0.020/0.020/0.020	0.025/0.025/0.025	
	Heating kW	0.020/0.020/0.020	0.020/0.020/0.020	0.020/0.020/0.020	0.020/0.020/0.020	0.025/0.025/0.025	
Running current	Cooling A	0.21/0.21/0.20	0.21/0.21/0.20	0.21/0.21/0.20	0.21/0.21/0.20	0.24/0.23/0.22	
	Heating A	0.20/0.20/0.19	0.20/0.20/0.19	0.20/0.20/0.19	0.20/0.20/0.19	0.23/0.22/0.21	
Fan	Type	Turbo fan					
	Air flow rate (H/M/L)	m ³ /h	768/726/690	768/726/690	870/780/690	930/780/690	990/810/690
		L/s	213/202/192	213/202/192	242/217/192	258/217/192	275/225/192
Motor output	kW	0.06					
Sound power level (H/M/L)	dB	45/44/43					
Sound pressure level (H/M/L)	dB(A)	30/29/28					
Dimensions* H x W x D	mm	256+(33.5) x 840 (950) x 840 (950)					
Pipe connections	Liquid	Ø6.35 (Ø1/4)					
	Gas	Ø12.7 (Ø1/2)					
	Drain piping	VP-25					
Net weight* (Panel)	kg	19 (+5)					

High-ceiling installation (Up to 5 m for 10.6 kW and higher capacity models)

The units can be installed in rooms with high ceilings, where they provide ample floor-level heating in the winter. (See ceiling height guidelines below.)

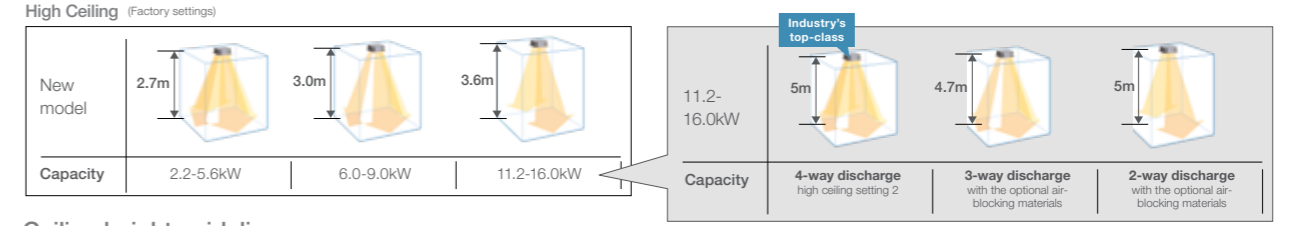

Ceiling height guidelines

Indoor unit	4-way discharge			3-way discharge (optional air-blocking materials)	2-way discharge (optional air-blocking materials) *2
	Factory setting 1	High ceiling setting 1	High ceiling setting 2		
2.2-5.6kW	2.7	3.2	3.5	3.8	4.2
6.0-9.0kW	3.0	3.3	3.6	3.8	4.2
11.2-16.0kW	3.6	4.3	5.0	4.7	5.0

*1 When using the unit in a configuration other than the factory settings, it is necessary to make settings on site to increase airflow.
*2 Use air-blocking materials (CZ-CFU3) to completely block two discharge outlets for 2-way airflow.

nanoe X Generator Mark 3

nanoe™ X contains plenty of OH radicals that have outstanding effects on various air pollutants, including bacteria and viruses, mould, allergens, pollen, hazardous substances, as well as deodorise odours. It also keeps moisture in your skin and hair.



S-60MU2E5BN	S-73MU2E5BN	S-90MU2E5BN	S-112MU2E5BN	S-140MU2E5BN	S-160MU2E5BN
220/230/240 V, 1 phase - 50Hz/60Hz					
6.0	7.3	9.0	11.2	14.0	16.0
20,500	24,900	30,700	38,200	47,800	54,600
7.1	8.0	10.0	14.0	16.0	18.0
24,200	27,300	34,100	47,800	54,600	61,400
0.035/0.035/0.035	0.040/0.040/0.040	0.040/0.040/0.040	0.095/0.095/0.095	0.095/0.095/0.095	0.105/0.105/0.105
0.035/0.035/0.035	0.040/0.040/0.040	0.040/0.040/0.040	0.090/0.090/0.090	0.090/0.090/0.090	0.100/0.100/0.100
0.34/0.33/0.32	0.37/0.36/0.35	0.39/0.38/0.37	0.77/0.74/0.71	0.77/0.74/0.71	0.85/0.82/0.79
0.33/0.32/0.31	0.36/0.35/0.34	0.38/0.37/0.36	0.75/0.72/0.69	0.75/0.72/0.69	0.83/0.80/0.77
Turbo fan	Turbo fan	Turbo fan	Turbo fan	Turbo fan	Turbo fan
1,260/960/780	1,350/960/780	1,380/1,110/840	2,160/1,560/1,200	2,160/1,560/1,200	2,220/1,680/1,440
350/267/217	375/267/217	383/308/233	600/433/333	600/433/333	617/467/400
0.06	0.06	0.06	0.09	0.09	0.09
51/47/44	52/47/44	53/50/47	60/54/50	60/54/50	61/55/53
36/32/29	37/32/29	38/35/32	45/39/35	45/39/35	46/40/38
319+(33.5) x 840 (950) x 840 (950)					
Ø9.52 (Ø3/8)	Ø9.52 (Ø3/8)	Ø9.52 (Ø3/8)	Ø9.52 (Ø3/8)	Ø9.52 (Ø3/8)	Ø9.52 (Ø3/8)
Ø15.88 (Ø5/8)	Ø15.88 (Ø5/8)	Ø15.88 (Ø5/8)	Ø15.88 (Ø5/8)	Ø15.88 (Ø5/8)	Ø15.88 (Ø5/8)
VP-25	VP-25	VP-25	VP-25	VP-25	VP-25
20 (+5)	20 (+5)	20 (+5)	25 (+5)	25 (+5)	25 (+5)

Global remarks
Rated conditions:
Cooling
Indoor air temperature 27°C DB / 19°C WB
Outdoor air temperature 35°C DB / 24°C WB
Rated conditions:
Heating
Indoor air temperature 20°C DB
Outdoor air temperature 7°C DB / 6°C WB
* The values in () for external dimensions and Net weight are the values for the optional ceiling panel. In the case of nanoe X OFF Specifications are subject to change without notice.

Y3 TYPE 4-WAY Mini Cassette



Mini semi concealed cassette

Optional accessory



Please refer to the nanoe™ X website for the Mark 3 information.



Technical focus

- Mini cassette fits into a 60 x 60 cm ceiling grid
- Powerful drain pump gives 850 mm lift
- Multi-directional air flow
- Easy installation
- DC fan motor with variable speed and a new heat exchanger ensures efficient power consumption
- nanoe™ X : 100x for CAC (100 times more nanoe™ particle for wide commercial space). Inside cleaning by 100x nanoe™ + dry control

Compact design

Thanks to advanced Panasonic design the panel is a compact 625 x 625 mm, offering elegant, unobtrusive installation even where space is limited.

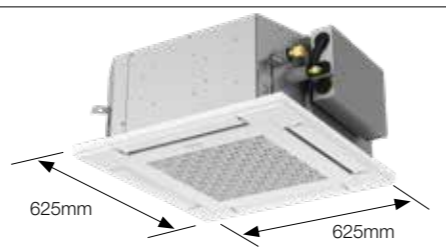

Lighter and slimmer, easier installation

When only 230 mm of indoor body height, it can easily fit in limited spaces and tight spots. (Required 243 mm from bottom of panel to top of the unit)

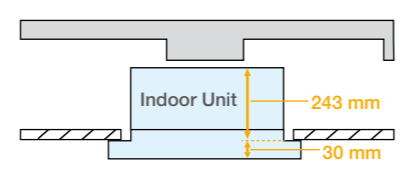

Individual flap control

Keep everyone comfortable by directing air where it's needed and away from where it isn't with individual flap control.

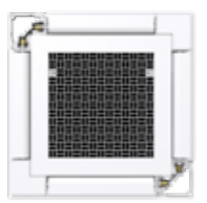

A drain height of up to 850 mm from the ceiling surface

The internal pump allows the drain pipe to be elevated up to 850 mm above the base of the unit.

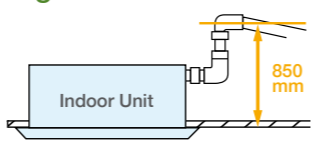

Model Name	S-22MY3E	S-28MY3E	S-36MY3E	S-45MY3E	S-56MY3E	
Power source	220/230/240 V, 1 phase - 50Hz/60Hz					
Cooling capacity	kW	2.2	2.8	3.6	4.5	5.6
	BTU/h	7,500	9,600	12,300	15,400	19,100
Heating capacity	kW	2.5	3.2	4.2	5.0	6.3
	BTU/h	8,500	10,900	14,300	17,100	21,500
Power input	Cooling kW	0.020	0.021	0.022	0.030	0.042
	Heating kW	0.018	0.019	0.020	0.028	0.040
Running current	Cooling A	0.25 0.24 0.23	0.26 0.25 0.24	0.27 0.26 0.25	0.35 0.34 0.33	0.44 0.43 0.42
	Heating A	0.22 0.21 0.20	0.23 0.22 0.21	0.24 0.23 0.22	0.32 0.31 0.30	0.41 0.40 0.39
Fan motor	Type	Turbo fan		Turbo fan		
	Airflow rate (H/M/L)	522/420/360		570/468/360		
	Output kW	0.03		0.03		
	Sound power level (H/M/L)	48/45/43		50/46/43		
Dimensions*	H x W x D mm	243(+30) x 575(625) x 575(625)		243(+30) x 575(625) x 575(625)		
	Liquid mm (inches)	Ø6.35 (Ø1/4)		Ø6.35 (Ø1/4)		
Pipe connections	Gas mm (inches)	Ø12.7 (Ø1/2)		Ø12.7 (Ø1/2)		
	Drain piping	VP-20		VP-20		
Net weight*	kg	15(+2.8)	15(+2.8)	15(+2.8)	15(+2.8)	15(+2.8)

Global remarks	Rated conditions:	
	Cooling	Heating
	Indoor air temperature 27°C DB / 19°C WB	20°C DB / 15°C WB
Outdoor air temperature 35°C DB / 24°C WB	7°C DB / 6°C WB	

* The values in () for external dimensions and Net weight are the values for the optional ceiling panel. Specifications are subject to change without notice.

L1 TYPE 2-WAY Cassette

Optional accessory

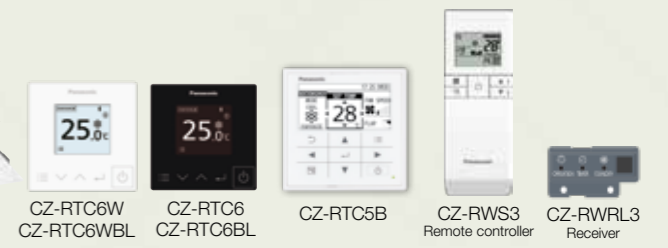

Technical focus

- Airflow and distribution is automatically altered depending on the operational mode of the unit
- Drain up is possible up to 500 mm via the built-in drain pump
- Simple maintenance

Auto flap control

Airflow and distribution is automatically altered depending on the operational mode (cooling or heating) of the unit.

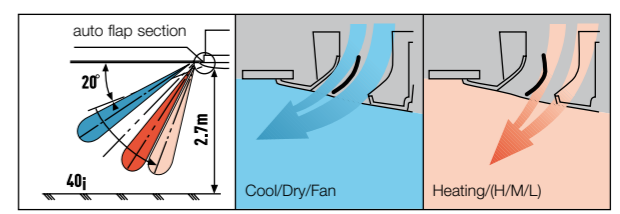

Drain up is possible up to 500 mm via the built-in drain pump.

Maintenance of the drain pump is possible from both sides, from the left side (piping side) and from the inside of the unit.

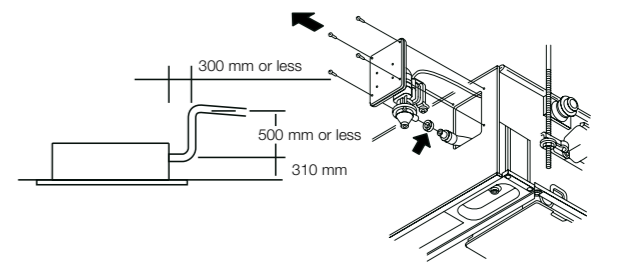

Simple maintenance

The drain pan is equipped with site wiring and can be removed. The fan case has a split construction, and the fan motor can be removed easily when the lower case is removed.

Model Name	S-22ML1E5	S-28ML1E5	S-36ML1E5	S-45ML1E5	S-56ML1E5	S-73ML1E5	
Power source	1 Phase/ 50Hz						
Cooling capacity	kW	2.2	2.8	3.6	4.5	5.6	7.3
	BTU/h	7,500	9,600	12,000	15,000	19,000	25,000
Heating capacity	kW	2.5	3.2	4.2	5.0	6.3	8.0
	BTU/h	8,500	11,000	14,000	17,000	21,000	27,000
Power input	Cooling kW	0.086/0.090/0.095	0.086/0.092/0.097	0.088/0.093/0.099	0.091/0.097/0.103	0.091/0.097/0.103	0.135/0.145/0.154
	Heating kW	0.055/0.058/0.062	0.055/0.060/0.064	0.057/0.061/0.066	0.060/0.065/0.070	0.060/0.065/0.070	0.100/0.109/0.117
Running current	Cooling A	0.45/0.45/0.45	0.44/0.45/0.45	0.44/0.45/0.45	0.45/0.45/0.45	0.45/0.45/0.45	0.64/0.65/0.66
	Heating A	0.29/0.29/0.30	0.28/0.29/0.30	0.28/0.29/0.30	0.29/0.29/0.30	0.29/0.29/0.30	0.46/0.48/0.49
Fan	Type	Sirocco fan		Sirocco fan		Sirocco fan	
	Air flow rate (H/M/L)	480/420/360		540/480/420		580/520/460	
	Output kW	0.03		0.03		0.03	
	Sound power level (H/M/L)	40/38/35		44/40/37		45/42/39	
Dimensions*	H x W x D mm	350+8x840 (1,060) x600 (680)		350+8x840 (1,060) x600 (680)		350+8x840 (1,060) x600 (680)	
	Liquid mm (inches)	Ø6.35 (Ø1/4)		Ø6.35 (Ø1/4)		Ø6.35 (Ø1/4)	
Pipe connections	Gas mm (inches)	Ø12.7 (Ø1/2)		Ø12.7 (Ø1/2)		Ø12.7 (Ø1/2)	
	Drain piping	VP-25		VP-25		VP-25	
Net weight*	kg	23 (+5.5)	23 (+5.5)	23 (+5.5)	23 (+5.5)	23 (+5.5)	30 (+9)

Global remarks	Rated conditions:	
	Cooling	Heating
	Indoor air temperature 27°C DB / 19°C WB	20°C DB
Outdoor air temperature 35°C DB / 24°C WB	7°C DB / 6°C WB	

* The values in () for external dimensions and Net weight are the values for the optional ceiling panel. Specifications are subject to change without notice.

D1 TYPE 1-WAY Cassette



Semi concealed slim cassette

Optional accessory



T2 TYPE Ceiling Mounted



Optional accessory



Technical focus

- Ultra-Slim profile
- Suitable for standard and high ceilings
- Built-in drain pump provides 590 mm lift from ceiling
- Easy to install and maintain
- Hanging height can be easily adjusted
- Uses a DC fan motor to improve energy-efficiency

Drain height

A built-in drain pump provides up to 590 mm lift from ceiling height for flexible install options.

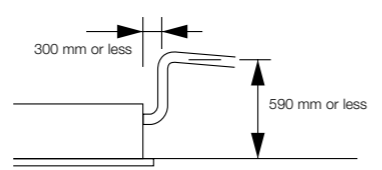

With 3 types of air-blow systems, the units can be used in various ways.



(1) One-direction "down-blow" system

Powerful one-direction "down-blow" system reaches the floor even from high ceilings (up to 4.2 m).



(2) Two-direction ceiling-mounted system

"Down-blow" and "front-blow" systems are combined in a ceiling-mounted unit to blow air over a wide area.



(3) One-direction ceiling-mounted system

This powerful ceiling-mounted "front-blow" system efficiently air-conditions the space in front of the unit. (Additional accessories required)

Model Name	S-28MD1E5	S-36MD1E5	S-45MD1E5	S-56MD1E5	S-73MD1E5
Power source	220/230/240 V, 1 phase - 50 / 60 Hz				
Cooling capacity	2.8				
	9,600				
Heating capacity	3.2				
	11,000				
Power input	0.050/0.051/0.052				
	0.039/0.040/0.042				
Running current	0.40/0.39/0.39				
	0.36/0.35/0.35				
Fan	Sirocco fan				
	720/600/540				
Sound power level (H/M/L)	47/45/44				
	36/34/33				
Dimensions * H x W x D	200+(20) x 1,000 (1,230) x 710 (800)				
	200+(20) x 1,000 (1,230) x 710 (800)				
Pipe connections	VP-25				
	VP-25				
Net weight *	21 (+5.5)				

Global remarks	Rated conditions:	
	Cooling	Heating
	Indoor air temperature	27°C DB / 19°C WB
Outdoor air temperature	35°C DB / 24°C WB	7°C DB / 6°C WB

* The values in () for external dimensions and Net weight are the values for the optional ceiling panel. Specifications are subject to change without notice.

Technical focus

- Lower sound levels
- Standardised height and depth for all models
- Long and wide air distribution
- Easy to install and maintain
- Fresh air knockout

Energy-saving technology Delivering top-class efficiency

Optimization of the shape of the casing and fan assures bigger air flow and higher efficiency. Energy-saving performance is top class in the industry.

Top Class Energy Saving

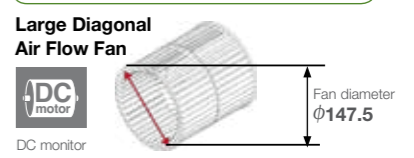

Comfortable, long-distance air flow distribution

The shape of the outlet has been optimized to provide long-distance air flow distribution. Even in deep spaces, air flow reaches every corner for exceptionally comfortable air conditioning.

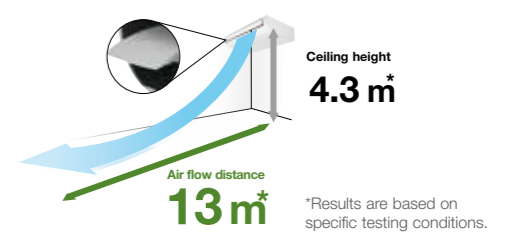

High Ceiling Setting	Air flow distance
*Setting by remote control	140
4.3m	13m

Multiple piping directions for flexible installation

The 5-directional drain pipe and 3-directional refrigerant pipe make installation much easier. And the neat fit with walls and ceilings assures more installation flexibility.

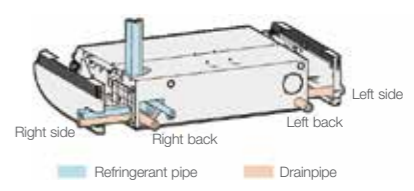

Model Name	S-36MT2E5A	S-45MT2E5A	S-56MT2E5A	S-73MT2E5A	S-106MT2E5A	S-140MT2E5A
Power source	220 / 230 / 240 V, 1 phase - 50 / 60 Hz					
Cooling capacity	3.6					
	12,300					
Heating capacity	4.2					
	14,300					
Power input	0.035/0.035/0.035					
	0.035/0.035/0.035					
Running current	0.37/0.36/0.35					
	0.37/0.36/0.35					
Fan	Sirocco fan					
	840/720/630					
Sound power level (H/M/L)	54/50/48					
	36/32/30					
Dimensions H x W x D	235 x 960 x 690					
	235 x 960 x 690					
Pipe connections	VP-20					
	VP-20					
Net weight	27					

Global remarks	Rated conditions:	
	Cooling	Heating
	Indoor air temperature	27°C DB / 19°C WB
Outdoor air temperature	35°C DB / 24°C WB	7°C DB / 6°C WB

Specifications are subject to change without notice.

P1 TYPE Floor Standing



Optional accessory



Technical focus

- Pipes can be connected to either side of the unit from the bottom or rear
- Easy to install
- Front panel opens fully for easy maintenance
- Removable air discharge grille gives flexible air flow

Effective perimeter air conditioning

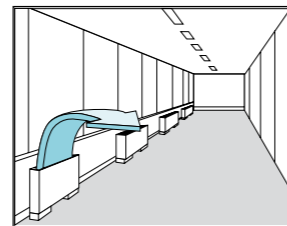

A wired remote control (CZ-RTC4/CZ-RTC5B) can be installed in the body

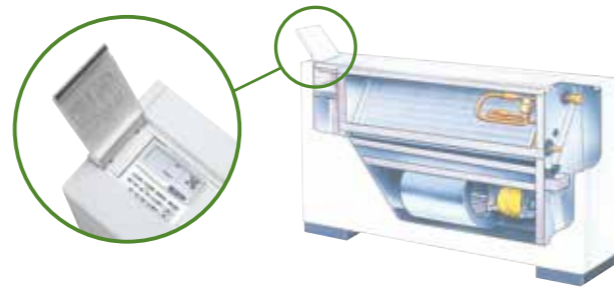

Model Name		S-22MP1E5	S-28MP1E5	S-36MP1E5	S-45MP1E5	S-56MP1E5	S-71MP1E5	
Power source		220/230/240 V, 1 phase - 50 / 60 Hz						
Cooling capacity	kW	2.2	2.8	3.6	4.5	5.6	7.1	
	BTU/h	7,500	9,600	12,000	15,000	19,000	24,000	
Heating capacity	kW	2.5	3.2	4.2	5.0	6.3	8.0	
	BTU/h	8,500	11,000	14,000	17,000	21,000	27,000	
Power input	Cooling kW	0.051/0.056/0.061	0.051/0.056/0.061	0.079/0.085/0.091	0.116/0.126/0.136	0.116/0.126/0.136	0.150/0.160/0.170	
	Heating kW	0.036/0.040/0.045	0.036/0.040/0.045	0.064/0.070/0.076	0.079/0.091/0.101	0.079/0.091/0.101	0.110/0.120/0.130	
Running current	Cooling A	0.24/0.25/0.26	0.24/0.25/0.26	0.37/0.38/0.39	0.54/0.56/0.58	0.54/0.56/0.58	0.70/0.72/0.73	
	Heating A	0.17/0.18/0.19	0.17/0.18/0.19	0.30/0.31/0.32	0.37/0.41/0.43	0.37/0.41/0.43	0.52/0.54/0.56	
Fan	Type	Sirocco fan						
	Air flow rate (H/M/L)	m³/h	420/360/300	420/360/300	540/420/360	720/540/480	900/780/660	1,020/840/720
		L/s	117/100/83	117/100/83	150/117/100	200/150/133	250/217/183	283/233/200
	Motor output kW	0.01	0.01	0.02	0.02	0.03	0.06	
Sound power level (H/M/L)	dB	44/41/39	44/41/39	50/46/40	49/46/42	50/47/42	52/49/46	
Sound pressure level (H/M/L)	dB(A)	33/30/28	33/30/28	39/35/29	38/35/31	39/36/31	41/38/35	
Dimensions	H x W x D	615 x 1,065 x 230	615 x 1,065 x 230	615 x 1,065 x 230	615 x 1,380 x 230	615 x 1,380 x 230	615 x 1,380 x 230	
	Liquid	mm (inches)	Ø6.35 (Ø1/4)	Ø6.35 (Ø1/4)	Ø6.35 (Ø1/4)	Ø6.35 (Ø1/4)	Ø6.35 (Ø1/4)	Ø9.52 (Ø3/8)
	Gas	mm (inches)	Ø12.7 (Ø1/2)	Ø12.7 (Ø1/2)	Ø12.7 (Ø1/2)	Ø12.7 (Ø1/2)	Ø12.7 (Ø1/2)	Ø15.88 (Ø5/8)
Pipe connections	Drain piping	VP-20						
Net weight	kg	29	29	29	39	39	39	

Global remarks	Rated conditions:	Cooling	Heating
	Indoor air temperature	27°C DB / 19°C WB	20°C DB
	Outdoor air temperature	35°C DB / 24°C WB	7°C DB / 6°C WB

Specifications are subject to change without notice.

R1 TYPE Concealed Floor Standing



Optional accessory



Technical focus

- Chassis unit for discrete customisable installation
- Complete with removable filters
- Pipes can be connected to the unit either from the bottom or rear
- Easy to install

Perimeter air conditioning with high interior quality

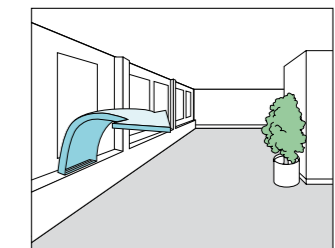

Model Name		S-22MR1E5	S-28MR1E5	S-36MR1E5	S-45MR1E5	S-56MR1E5	S-71MR1E5	
Power source		220/230/240 V, 1 phase - 50, 60 Hz						
Cooling capacity	kW	2.2	2.8	3.6	4.5	5.6	7.1	
	BTU/h	7,500	9,600	12,000	15,000	19,000	24,000	
Heating capacity	kW	2.5	3.2	4.2	5.0	6.3	8.0	
	BTU/h	8,500	11,000	14,000	17,000	21,000	27,000	
Power input	Cooling kW	0.051/0.056/0.061	0.051/0.056/0.061	0.079/0.085/0.091	0.116/0.126/0.136	0.116/0.126/0.136	0.150/0.160/0.170	
	Heating kW	0.036/0.040/0.045	0.036/0.040/0.045	0.064/0.070/0.076	0.079/0.091/0.101	0.079/0.091/0.101	0.110/0.120/0.130	
Running current	Cooling A	0.24/0.25/0.26	0.24/0.25/0.26	0.37/0.38/0.39	0.54/0.56/0.58	0.54/0.56/0.58	0.70/0.72/0.73	
	Heating A	0.17/0.18/0.19	0.17/0.18/0.19	0.30/0.31/0.32	0.37/0.41/0.43	0.37/0.41/0.43	0.52/0.54/0.56	
Fan	Type	Sirocco fan						
	Air flow rate (H/M/L)	m³/h	420/360/300	420/360/300	540/420/360	720/540/480	900/780/660	1,020/840/720
		L/s	117/100/83	117/100/83	150/117/100	200/150/133	250/217/183	283/233/200
	Motor output kW	0.01	0.01	0.02	0.02	0.03	0.06	
Sound power level (H/M/L)	dB	44/41/39	44/41/39	50/46/40	49/46/42	49/46/42	52/49/46	
Sound pressure level (H/M/L)	dB(A)	33/30/28	33/30/28	39/35/29	38/35/31	39/36/31	41/38/35	
Dimensions	H x W x D	616 x 904 x 229	616 x 904 x 229	616 x 904 x 229	616 x 1,219 x 229	616 x 1,219 x 229	616 x 1,219 x 229	
	Liquid	mm (inches)	Ø6.35 (Ø1/4)	Ø6.35 (Ø1/4)	Ø6.35 (Ø1/4)	Ø6.35 (Ø1/4)	Ø6.35 (Ø1/4)	Ø9.52 (Ø3/8)
	Gas	mm (inches)	Ø12.7 (Ø1/2)	Ø12.7 (Ø1/2)	Ø12.7 (Ø1/2)	Ø12.7 (Ø1/2)	Ø12.7 (Ø1/2)	Ø15.88 (Ø5/8)
Pipe connections	Drain piping	VP-20						
Net weight	kg	21	21	21	28	28	28	

Global remarks	Rated conditions:	Cooling	Heating
	Indoor air temperature	27°C DB / 19°C WB	20°C DB
	Outdoor air temperature	35°C DB / 24°C WB	7°C DB / 6°C WB

Specifications are subject to change without notice.

Smart Connectivity and Control Solutions

Panasonic offers a range of smart connectivity and control solutions for residential and commercial applications that allows you to conveniently manage and monitor air conditioning units in single or multiple locations from one mobile device.



For Residential

Panasonic Comfort Cloud

Personal Control Solutions Panasonic Comfort Cloud

- Remotely manage and monitor multiple air conditioning units in your home
- Easily control and access all features of the air conditioning units with smart centralised control.

CZ-CAPWFC1
Network adaptor. Available for all types of VRF indoor units.

**CZ-RTC6WBLW
CZ-RTC6BLW**
WLAN remote controller
*Available for particular types of VRF indoor units. Please consult with Panasonic sales engineers.

For Light Commercial

Panasonic Comfort Cloud VRF Smart Connectivity+

Cost effective Energy Management Solution



- Multiple location control at your convenience with Comfort Cloud
- Gain control of multiple zones and sites intuitively adjusting temperature by areas with differentiated user rights settings.
- Indoor Air Quality (IAQ) and efficient energy usage with VRF Smart Connectivity+
- Ultimate cooling comfort with sensing technology and automatic IAQ control.
 - Simplified Plug & Play installation with BMS connection for better energy consumption.

Wide Range of Smart Control Solutions for All Needs

Whether you need to control multiple sites, a single office, or your home, we offer a range of innovative smart control solutions for a variety of needs.

Panasonic Comfort Cloud

Intuitive and scalable air conditioning control solution using a personal mobile device.

VRF Smart Connectivity+

Offers efficient energy management with high indoor air quality (IAQ) control.

Panasonic AC Smart Cloud

Monitor and manage energy consumption of multiple location through a cloud computing system.

For Multiple Building Management

Panasonic AC Smart Cloud

Full Control of All Installations From A Single Internet Connection Panasonic AC Smart Cloud

- Manage and monitor energy consumption patterns
- Analyse energy usage, running time and optimise temperatures to reduce energy costs.
- Centralised control solution with zero downtime
- Receive real-time status updates to prevent breakdowns.
- Flexible and scalable solution for expanding businesses and multi sites
- Adaptable solutions that can easily be upgraded for new features, meet user demand and better IT management.

Panasonic Comfort Cloud

Control air conditioning units from wherever and whenever with your smartphone, by using Panasonic Comfort Cloud and WLAN smart adaptor.

This scalable solution is ideal for one system, one site or multiple locations. Coupling the adaptor with the already feature rich systems, makes it an ideal solution for both residential and commercial applications.



For Residential

Remotely manage and monitor air conditioning units from anywhere anytime.

For Light Commercial

Gain control of multiple zones and sites intuitively up to 200 indoor units.

Panasonic Comfort Cloud features

From 1 to 200 units

User can control up to 200 indoor units. 10 different sites, with up to 20 units / groups per site.



Multiple User

The Panasonic Comfort Cloud App allows multiuser access control. Restrict user access to specific units.



Easy Scheduling

Complex weekly scheduling made simple. Not only for one units, but across multiple sites and from a smartphone.

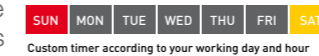

Error Codes

Error code notification through the App, provides early notification and allows for faster repair.



Application examples



Centralised control from reception.



Multiple location control for small businesses.

System configuration

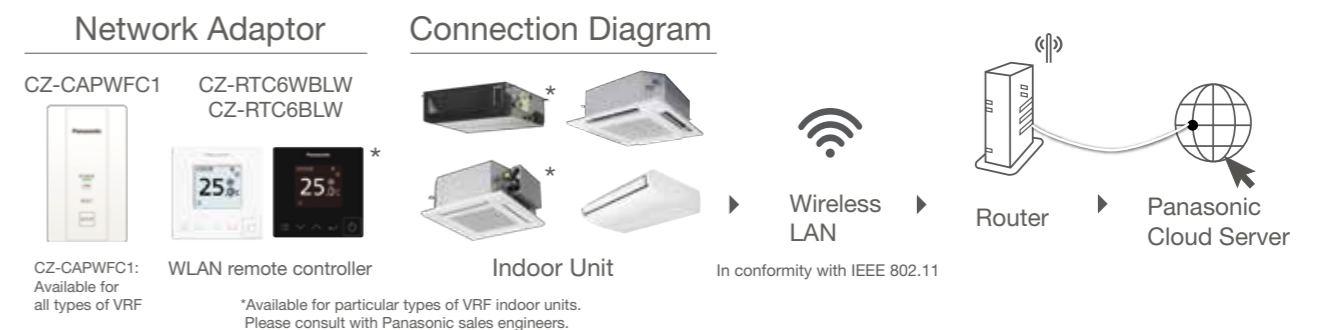

WLAN smart adaptor specification

CZ-CAPWFC1	
Input Voltage	DC 12V (Supplied from indoor unit)
Power Consumption	Maximum 2.4W
Size [H x W x D]	120 x 70 x 25mm
Weight	190g (including communications lines)
Interface	Wireless LAN
Wireless LAN Standard	IEEE 802.11 b/g/n
Frequency range	2.4GHz band
Encryption	WPA2-PSK(TKIP/AES)
Operation range	0-55°C, 20 - 80RH%



Comfort Cloud App



Scan QR code to download free Panasonic Comfort Cloud App

Compatible Device and Browsers

1. IOS 9.0 or above
2. Android™ 4.4 or above

VRF Smart Connectivity+

Through thorough energy management, Panasonic's VRF Smart Connectivity+ is a completely new, state-of-the-art solution providing energy saving and comfort as well as simple installation, operation and running.



Dramatic reduction of OpEx with outstanding IAQ.
 3 built-in sensors: Temperature, RH and occupancy.
 ZigBee wireless sensors: CO₂ / temperature / RH%, window / door, ceiling / wall / water leakage.
 Relay Pack, Hotel Room Controller.



User-/owner-friendly.
 Colour touch screen.
 Simple and easy to use.
 22 languages.
 Easy-to-understand error description.



Ultimate customisation.
 Customisable colour background.
 Custom display/icons, messages.
 Programmable logic (also stand alone).
 Various controls and various external connection devices.



Easy design and Plug & Play to reduce CapEx.
 Simple Plug & Play VRF connection to Building Energy Management System (BEMS).
 Stand alone or BEMS connected.
 Easy installation of ZigBee sensors.

VRF Smart Connectivity+ offers efficient energy management and a new air conditioning control solution with high IAQ (indoor air quality).



Energy management system for rooms.

Each room is monitored by high-precision sensors, making it possible to make every room's temperature comfortable without wasting energy.

Management system for the entire building.

A Building Energy Management System (BEMS) can also be connected for Plug & Play centralised control of the building's entire energy consumption.

1 Quality air control

Optimum IAQ is realized using the CO₂ and humidity sensors. The interior environment remains comfortable, while heating and cooling costs are minimized. The CO₂ sensor can control ventilation systems, which contribute to improving the room's air quality.

2 Easy installation and integration

A remote controller is all that's required for occupancy control and optimum automatic indoor air quality (IAQ) control. Simple operation with a rented interface further contributes to increased energy efficiency and productivity for reduced capital expenditure (CapEx) and operating expense (OpEx).

3 Other equipment control

One room controller manages various devices including lighting and the blinds. A ventilation system and other external connection devices can be connected by using HRC or SE8350 so that various control is possible with this controller alone, even without BMS.

VRF Smart Connectivity+: SER8150.

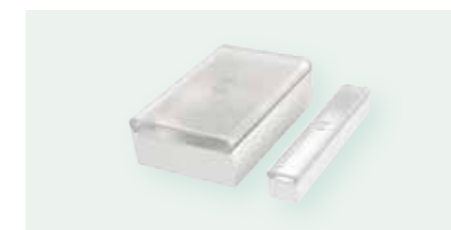

Door/window sensor.
 Door and window contact detection sensor to monitor opening and closing.



Wall/ceiling motion/temperature/humidity sensor.
 Wall and ceiling sensor to detect the presence or absence of occupants.



CO₂ /temperature/humidity sensor.
 Monitor indoor air quality, review data on interfacing devices, and control fresh air inside customisable zones.



Water leakage sensor.
 Two sensing pads under the body activate when water is present between the two pads. Detecting the water, the sensor reports the event to the controller (and BEMS).



Hotel Room Controller (HRC).
 The Hotel Room Controller controls connected guest room devices and aggregates data, making it visible to guest room and property management systems.

Energy management system for rooms

By installing a wall/ceiling motion temperature sensor, window/door sensor, and CO₂ sensor in the room, ideal, waste-free air conditioning is achieved.

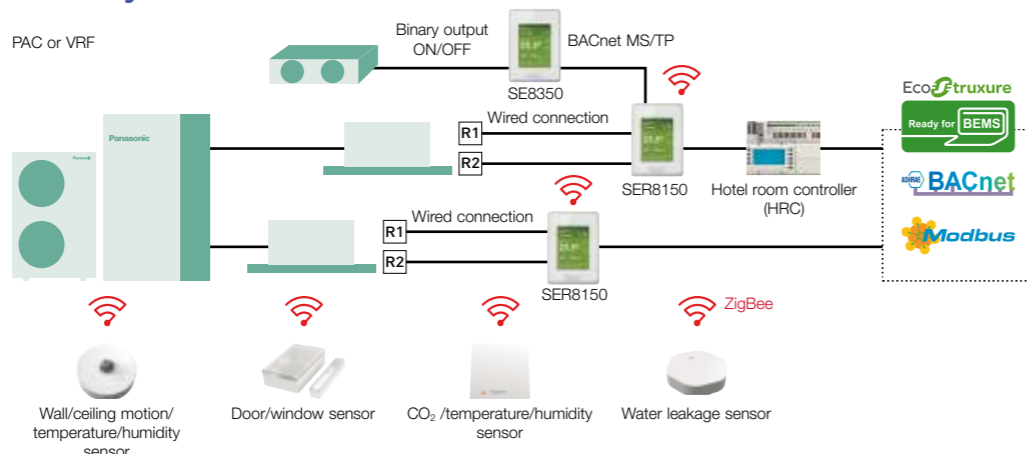

Sensing and control technology

Using sensors from Schneider Electric, high-quality occupancy control and automatic IAQ control are realised. The sensors detect the presence or absence of occupants, and the opening and closing of doors and windows to achieve the most efficient energy management for exceptional air-conditioned comfort. Flexible installation is possible to match different applications and building features such as walls, ceilings and proximity to doors and windows. No wiring means extra installation versatility.

Batteries last for up to five years (10-year battery for CO₂ sensor) and are easy to install and replace.

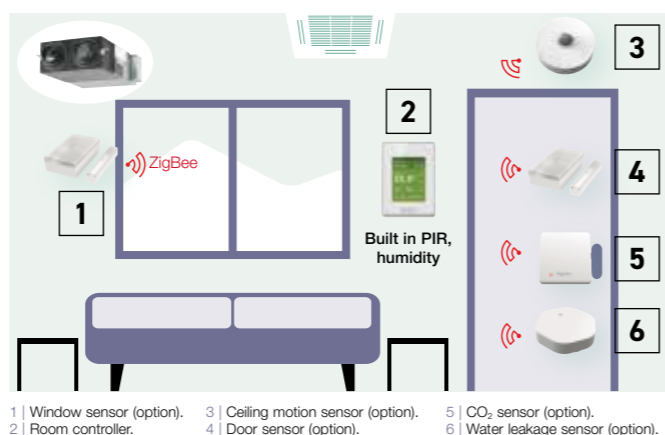

1 | Window sensor (option). 2 | Room controller. 3 | Ceiling motion sensor (option). 4 | Door sensor (option). 5 | CO₂ sensor (option). 6 | Water leakage sensor (option).

Pana Net Con, RH, No PIR, SE Brand, R1R2. SER8150R0B1194



Pana Net Con, RH, PIR, SE Brand, R1R2. SER8150R5B1194



Wireless ZigBee® Pro communication card. VCM8000V5094P

Hotel room expansion module 14 indoor units. HRCEP14R



Hotel room controller 28 indoor units. HRCBP28R



Hotel room controller w/display 42 indoor units. HRCPDG42R



* Those accessories require system integrator support on site.

Sensor with room CO₂, temperature and humidity. SED-CO2-G-5045



Sensor with room temperature and humidity. SED-TRH-G-5045



Door/window sensor. SED-WDC-G-5045



Wall/ceiling motion/temperature/humidity sensor. SED-MTH-G-5045



Water leakage sensor. SED-WLS-G-5045



Cover frame. Silver. FAS-00



Cover frame. White. FAS-01



Cover frame. Glossy translucent white. FAS-03



Cover frame. Light tan wood. FAS-05



Cover frame. Dark brown wood. FAS-06



Cover frame. Dark black wood. FAS-07



Cover frame. Brushed steel finish. FAS-10



Up to 5 year battery life (batteries included). Battery life of CO₂ sensor up to 10 years. Battery level data point.

Smart management solutions



1 Hotels

Room key card or key cardless solutions for hotels. The SER8150 and ZigBee sensor automatic detection function offer optimal air conditioning regardless of whether there is a hotel room key or not. Sensors detect the presence or absence of occupants and the opening and closing of doors and windows for the optimum air-conditioned environment guests expect. Automatic control ensures the most efficient operation when guests are away or when windows are open. This contributes to an appreciable reduction in operation costs.



2 Small and medium offices

CO₂ sensors (option) and humidity sensors. CO₂ sensors (option) take measurements in units of ppm, and humidity sensors enable fine air quality control. This creates the most comfortable space for occupants while contributing to improved employee satisfaction.



3 Super markets

Humidity sensors. Humidity sensors enable automatic dehumidification for the optimum IAQ regardless of climatic conditions. This creates an even more comfortable environment for customers, employees, and products themselves.

Innovative and unrivalled advantages



Colour and design to match office interiors.
Colour combinations and design can be set to match different facilities.



Easy-to-understand error description.
Error description during an emergency is easy to understand, enabling staff to respond quickly.

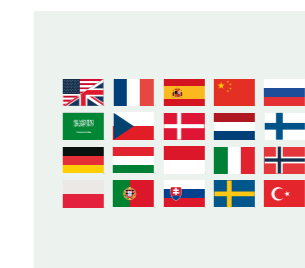

Customisation in 22 languages possible.
The display can be customised to match the native languages of guests to enable smooth, stress-free communication for hospitality at its finest.



Programmable logic.
Full customisation of remote controller logic possible, and updating to match conditions.



Panasonic AC Smart Cloud

With Panasonic AC Smart Cloud, have your business under control, and start saving!



Key functions and uniqueness

Multi site monitoring.

- It doesn't matter how many sites you have, easy to manage, operate, compare sites, locations, rooms.



Schedule setting.

- Yearly / weekly / holiday timer setting as you want



Powerful statistics for energy savings.

- Power consumption, capacity, efficiency level can be compared with different parameters (Yearly / monthly / weekly / daily bases)



Maintenance notification.

- Error notification by email and with floor layout
- Maintenance notification of PAC / VRF outdoor units
- Remote service checker function



User customisation¹.

Site administrator can create users as desired and assign customised profiles.

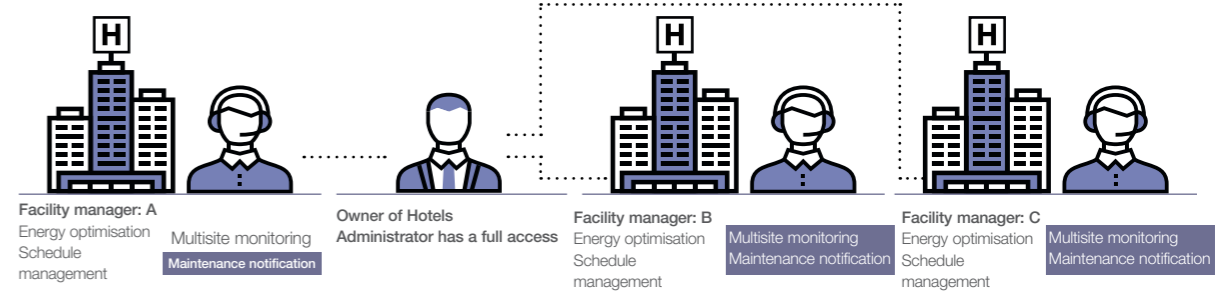

Flexible and scalable solution

- Energy saving
- Zero downtime
- Site(s) management

Centralise control of your business premises, from wherever you are, 24/7/365.

It doesn't matter how many sites you have, or where they are!

The AC Smart Cloud system from Panasonic allows you to have complete control of all your installations, from your tablet or from your computer.

In a simple click, all your units from several locations, receive status updates in real-time of all your installations, preventing breakdowns and optimising costs.

Flexible solution for your business.

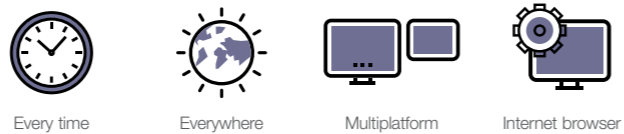

Scalable solution for your business.



* Customised to meet user demand / Continuous upgrades: new functions and product introductions / IT smart management.

Panasonic AC Smart Cloud offers continuous improvement always thinking about users

New e-CUT function

E-CUT functions are newly available in Panasonic AC Smart Cloud.

5 energy saving settings reduces automatically its energy consumption.

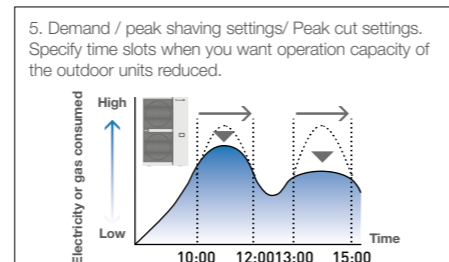
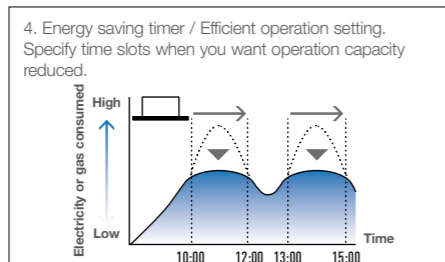
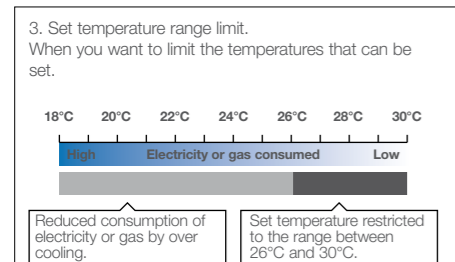
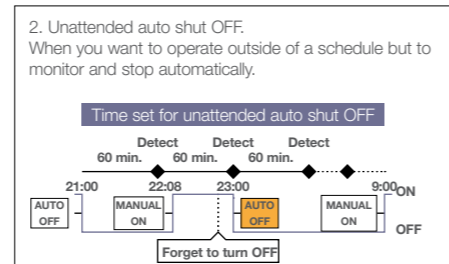
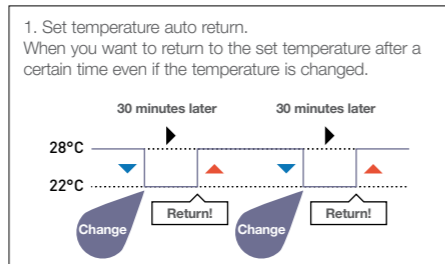

Main functions per user type

Function / Main Tab	Sub-Tab	Basic type (Eg.: Owners, facility managers)	Professional type (Eg.: Installers, maintenance companies)
AC setting	I / U / O / U operation details	✓	✓
	Cloud adapter (CZ-CFUSCC1) details	✓	✓
	AC maintenance	✓	✓
	Map view	✓	✓
Energy saving function	NEW e-CUT	✓	✓
	Yearly, weekly schedule setting / view	✓	✓
Schedule	Power consumption	✓	✓
	Capacity	✓	✓
Powerful statistics	Efficiency ranking	✓	✓

Function / Main Tab	Sub-Tab	Basic type (Eg.: Owners, facility managers)	Professional type (Eg.: Installers, maintenance companies)
Maintenance function	Notification overview / details	✓	✓
	Maintenance settings	✓	✓
	Map view	✓	✓
	Remote service checker	✓	✓
User account ¹	New / update user registration	✓	✓
	Distribution group overview / details	✓	✓
System setting	Cut OFF request	✓	✓
	Map editor	✓	✓

Remote service checker function

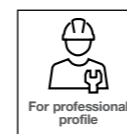

Zero down time

- Quick analysis & response
- Time & Cost saving for service maintenance task

Recording service checker parameters from wherever you are!

- Data duration: Maximum 120 minutes
- Data frequency: 10 – 90 seconds
- Mode selection: With test run or Without test run
- Count down schedule setting available

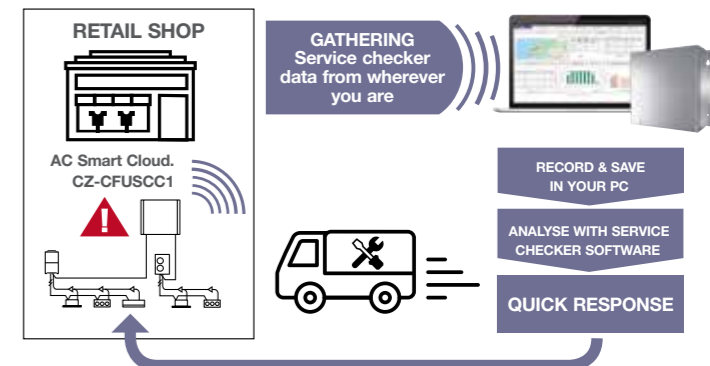

Panasonic AC Smart Cloud parts lists

* Cloud service fee is additionally required. Please contact an authorised Panasonic dealer.

CZ-CFUSCC1 AC Smart Cloud communication adaptor. Up to 128 groups. 128 units control

¹) Please contact an authorized Panasonic dealer.

FSV Controllers

A wide variety of control options to meet the requirements of different applications.

ECONAVI ECONAVI Sensor

Providing outstanding energy-saving performance, Panasonic's inverter VRF System can be connected to ECONAVI to detect when energy is being wasted. ECONAVI senses the presence or absence of people and the level of activity in each area of an office. When unnecessary heating or cooling is detected, indoor units are individually controlled to match office conditions for energy-saving operation.



ECONAVI Sensor CZ-CENS1

Detection of the level of activity enables optimum power saving

Activity or absence of people at their desks and the level of activity in the office are detected in real time. Cooling or heating is automatically adjusted for optimum operation required to lower power consumption.

Sensor is remotely located to maximize the energy saving effect

Pillars, walls, cabinets and other fittings obstruct the sensors, reducing the area of detection and lowering the energy-saving effect. Taking into consideration blind spots, Panasonic enables the optimum layout for sensors in any office.

Remote temperature sensor

- This is a remote sensor which can be used with indoor units. Use it to detect the room temperature when no remote controller sensor or body sensor is used (connection to a system without a remote controller is possible).
- For joint use with a remote control switch, use the remote control switch as main remote controller.



CZ-CSRC3

Operation system	Individual control systems			
Requirements	Simplified high-spec operation	High-spec operation	Normal operation	Operation from anywhere in the room
External appearance				
Type, model name	Simplified high-spec Wired Remote Controller with Bluetooth CZ-RTC6W/CZ-RTC6WBL/ *CZ-RTC6WBLW (White) CZ-RTC6/CZ-RTC6BL/ *CZ-RTC6BLW (Black) <small>*Available for particular types of VRF indoor units.</small>	High-spec Wired Remote Controller CZ-RTC5B	Timer Remote Controller (Wired) CZ-RTC4	Wireless Remote Controller Controller: CZ-RWS3 Receiver: CZ-RWRU3 CZ-RWRY3 CZ-RWRL3 CZ-RWRD3 CZ-RWRT3 CZ-RWRC3
Built-in thermostat	●	●	●	—
nanoe™ X on/off control <small>*not applies to Floor Console</small>	●	●	—	●
ECONAVI ON/OFF control	●	●	●	●
Number of indoor units which can be controlled	1 group, 8 units	1 group, 8 units	1 group, 8 units	1 group, 8 units
Use limitations	· CZ-RTC6(W) : Up to 2 controllers can be connected per group (only combination possible with CZ-RTC6(W)) · CZ-RTC6(W)BL/CZ-RTC6(W)BLW : Up to 1 controller can be connected per group	· Up to 2 controllers can be connected per group (When using ECONAVI sensor, only one remote controller is possible to connect at indoor unit)	· Up to 2 controllers can be connected per group (When using ECONAVI sensor, only one remote controller is possible to connect at indoor unit)	· Up to 2 controllers can be connected per group.
Function ON/OFF	●	●	●	●
Mode setting	●	●	●	●
Fan speed setting	●	●	●	●
Temperature setting	●	●	●	●
Air flow direction	●	●	●	●
Permit/Prohibit switching	—	—	—	—
Weekly program *	●	●	●	—

All specifications are subject to change without notice.
*(CZ-RTC6(W)BL/CZ-RTC6(W)BLW with H&C Control App)

Timer operation	Centralised control systems				BMS System PC Base	Connection with 3rd Party Controller
Daily and weekly program	Operation with various functions from a central location	Only ON/OFF operation from a central location	Simplified load distribution ratio (LDR) for each tenant 10.4 in. touch screen panel color LCD			
Schedule Timer	System Controller	ON/OFF Controller	Intelligent Controller	P-AIMS Software Up to 1024 units 	Seri-Para I/O unit for outdoor unit CZ-CAPDC2	
CZ-ESWC2	CZ-64ESMC3	CZ-ANC3	CZ-256ESMC3 (CZ-CFUNC2)	Optional software 	Interface Adaptor CZ-CAPC3	
—	—	—	—	—	Seri-Para I/O unit for each indoor unit 	
64 groups, max. 64 units	64 groups, max. 64 units	16 groups, max. 64 units	64 units x 16 systems, max. 256 units	CZ-CSWAC2 for Load distribution CZ-CSWWC2 for Web application CZ-CSWGC2 for Object layout display CZ-CSWBC2 for BACnet software interface <small>*PC required (field supply)</small>	Communication Adaptor CZ-CFUNC2	
· Required power supply from the system controller · When there is no system controller, connection is possible to the T10 terminal of an indoor unit.	· Up to 10 controllers, can be connected to one system. · Main unit/sub unit (1 main unit + 1 sub unit) connection is possible. · Use without remote controller is possible.	· Up to 8 controllers (4 main units + 4 sub units) can be connected to one system. · Use without remote controller is impossible.	· A communication adaptor (CZ-CFUNC2) must be installed for three or more links.		LonWorks Interface CZ-CLNC2	
—	●	●	●			
—	●	—	●			
—	●	—	●			
—	●	—	●			
—	●	—	●			
—	●	●	●			
●	●	—	●			

Panasonic Total Air Conditioning Management System P-AIMS

P-AIMS basic software / CZ-CSWKC2

Up to 1024 indoor units can be controlled by one PC

Functions of basic software

- Standard remote control for all indoor units
- Many timer schedule programs can be set on the calendar
- Detailed information display for alarms
- CSV file output with alarm history, operating status.
- Automatic data backup to HDD



With 4 upgrade packages the basic software can be upgraded to suit individual requirements. For Load Distribution software, digital power meter c/w pulse require (field supply)



CZ-CFUNC2



The P-AIMS is ideal for large areas/buildings such as shopping centers, universities and office buildings.

Each line can have max.8 communication adaptor units, and control max.512 units.

In total, 1024 indoor units can be controlled by 1 "P-AIMS" PC.

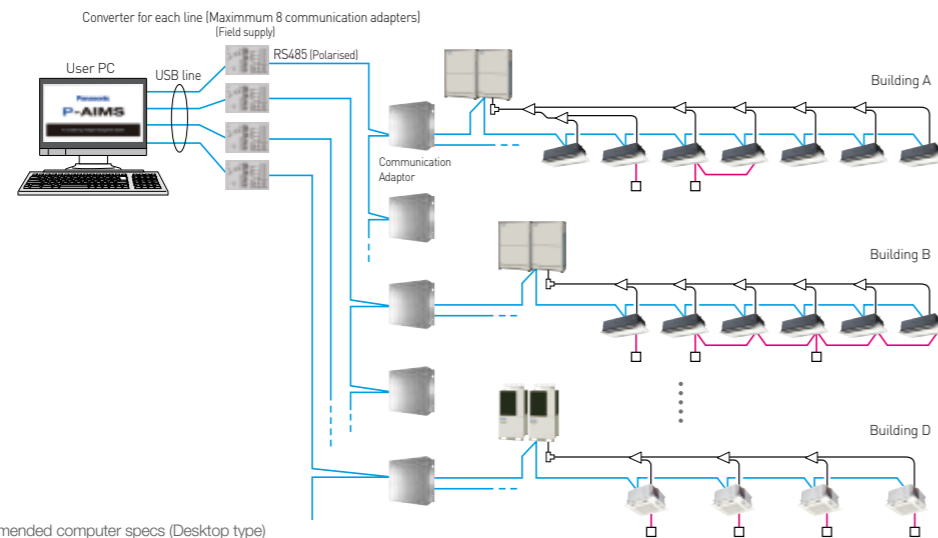

Recommended computer specs (Desktop type)

Operating system	Windows 10 Pro 64bit
CPU	Intel Core™ i5-6500 3.20GHz or higher (Recommended computer) Intel Core™ i7-7700 3.60GHz or higher (When installing Layout Display Software or using 512 or more indoor units)
Memory	8GB or larger
HDD	SSD (Solid State Drive) 250GB or larger
Monitor	1920 x 1080 (full HD) Recommended (1280 x 1024 (SXGA) minimum)
(Built-in speaker)	1920 x 1080 (full HD) Required (when installing Layout Display Software)
External HDD	500GB or larger (An external power supply type is preferable because the HDD will be used for backing up data.)
LAN	Network adaptor equipped machine (when Web Software or BACnet Communication Software installed)
UPS (Field Supply)	Select a UPS with a sine output wave form

Intelligent Controller (CZ-256ESMC3)



Touch panel
 Dimensions: H 240 x W 280 x D 85 mm
 Power supply: AC 100 to 240 V (50/60 Hz)
 LCD: 10.4 in. TFT, XGA(1024 x 768), LED backlight
 UPS (Field Supply): select UPS with a sine output wave form

Product features

- 10.4 in., large, easy-to-use color LCD
 - With smartphone like operations, such as swiping and flicking
- Enhanced energy-saving control functions
 - Packed with demand functions
 - Set temperature auto return settings, Auto shutoff, Set temperature range limit settings
- Energy visualization
 - Displays electricity & gas usage distribution
 - Supports energy-saving plans with graph display function

New features

- Max 256 indoor unit [4 links x 64 units] can be controlled. In case of three or more links [more than 128 units], a communication adaptor CZ-CFUNC2 must be installed for three or more links.
- Operation is possible as batch, in zone units, and in group units.
- ON/OFF, operation mode setting, temperature setting, for fan speed setting,

air flow direction setting (when used without a remote controller) and remote controller local operation prohibition [prohibition 1,2,3,4] can be done

- Graph display [trends, comparisons]
- ECONAVI ON/OFF
- Outdoor unit quiet operation ON/OFF
- Energy-saving functions
- Event control [such as equipment linkage]
- Limitation contents for prohibited operation

Prohibition means limitation of the operation contents from the remote controller. It is also possible to change the prohibition items.

Limitation contents (Limitations can be user defined)

Individual	There is no limitation for the operation of the remote controller. However, the contents will be changed to the contents of the controller operated last. (Last-pressed priority.)
Prohibition 1	The remote controller cannot be used for ON/OFF. (All other operations are possible from the remote controller.)
Prohibition 2	The remote controller cannot be used for ON/OFF, operation mode change and temperature setting. (All other operations are possible from the remote controller.)
Prohibition 3	The remote controller cannot be used for operation mode change and temperature setting. (All other operations are possible from the remote controller.)
Prohibition 4	The remote controller cannot be used for operation mode change. (All other operations are possible from the remote controller.)

Remote control

The LAN terminal on this unit enables you to connect to a network. Connecting to internet will enable you to operate the unit and check the status using a PC from remote location.

Power Distribution function

You can view cumulative electrical consumption per indoor unit or in a area. Digital power meter with pulse require (Field Supply) for this function

Gateway for Panasonic Communication Adaptor



Gateway for Panasonic FSV systems integration into BACnet / KNX / Modbus / Home Automation networks

Easily connect with integrated controllers to become part of your building management system.

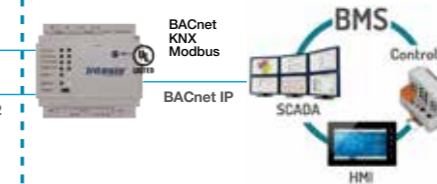
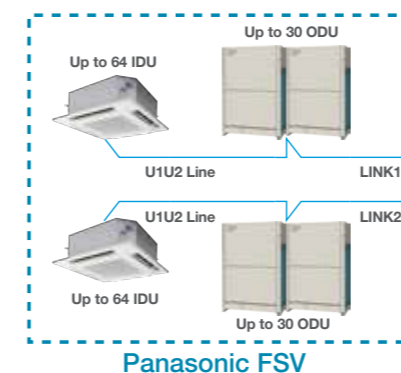

For further information, please check IntesisBox website. <https://www.intesisbox.com/>

Panasonic VRF Global Project References

Panasonic air conditioning systems provides comprehensive solutions to businesses around the world. Harnessing our advanced technology and extensive on-site expertise, we serve clients in a diverse range of environments throughout the world.

HOTEL

Australia Travelodge Hobart



Air Conditioning System:
VRF 3-way FSV MF2 series 8 systems
Indoor Units: 116 units
Cooling Capacity:
302 kW / 86 USRT

Indonesia Patra Jasa Hotel



Air Conditioning System:
VRF 2-way FSV ME1 series 14 systems
Indoor Units: 132 units
Cooling Capacity:
677 kW / 193 USRT

Spain Hotel Claris 5 GL



Air Conditioning System:
VRF 2-way ME1&LE1 series 11 systems
VRF 3-way MF1 series 14 systems
Indoor Units: 233 units
Cooling Capacity: 769 kW / 218 USRT

Spain Monument Hotel



Air Conditioning System:
VRF 2-way ME1 series 4 systems,
VRF 3-way 12 systems
Indoor Units: 171 units
Cooling Capacity:
592 kW / 168.33 USRT

Spain LAVIDA Hotel PGA Catalunya Resort



Air Conditioning System:
VRF 2-way FSV ME2 series 2 systems
Indoor Units: 54 units
Cooling Capacity: 236 kW / 67 USRT

Russia River Park Hotel



Air Conditioning System:
VRF 2-way ME1 series 47 systems
Indoor Units: 96 units
Cooling Capacity: 788 kW / 224 USRT

Germany The LEGOLAND Castle Hotel



Air Conditioning System:
VRF 3-way MF2 series 12 systems
Indoor Units: 144 units
Cooling Capacity:
592 kW / 168.33 USRT

Ireland K Club, Co. Kildare



Air Conditioning System:
VRF 3-way FSV MF2 series 10 systems
Indoor Units: 70 units
Cooling Capacity: 200 kW / 56.87 USRT

OFFICE

Malaysia Gapruna project



Air Conditioning System:
VRF 2-way FSV ME1 series 109 systems
Indoor Units: 537 units
Cooling Capacity:
5,370 kW / 1,526 USRT

Malaysia Plaza 33 Office Block A



Air Conditioning System:
VRF 2-way FSV ME1 series 99 systems
Indoor Units: 153 units
Cooling Capacity:
3,667 kW / 1,042 USRT

Thailand Areeya



Air Conditioning System:
VRF 2-way FSV ME1 series 19 systems
Single split system 67 systems
Indoor Units: 85 units
Cooling Capacity:
1,519 kW / 432 USRT

HongKong King Yip Road



Air Conditioning System:
VRF FSM LA1 series 136 systems
Indoor Units: 294 units
Cooling Capacity:
2,108 kW / 599 USRT

England Soapworks



Air Conditioning System:
VRF 3-way ME1 series 77 systems
with ERV 167 systems

Spain PTA Malaga



Air Conditioning System:
VRF 2-way ME1 series 20 systems
Indoor Units: 74 units
Cooling Capacity:
908 kW / 258 USRT

Russia Russian Government Building



Air Conditioning System:
VRF 2-way ME1 series 42 systems
Indoor Units: 277 units
Cooling Capacity:
2,045 kW / 581 USRT

New Zealand IAG Christchurch



Air Conditioning System:
VRF 3-PIPE FSV MF2 series: 25 systems
Indoor Units: 132 units
Cooling Capacity:
976 kW / 278 USRT

RETAIL

Italy Le Centurie CENTRO COMMERCIALE



Air Conditioning System:
VRF 3-way ME1 series 18 systems
Indoor Units: 57 units
Cooling Capacity:
656 kW / 186 USRT

India Sai Aarav Motors, Mehsana



Air Conditioning System:
VRF 2-way FSV ME1 series 3 systems
Indoor Units: 19 units
Cooling Capacity: 156 kW / 44 USRT

Russia Sun City Mall



Air Conditioning System:
VRF 2-way ME1 series 47 systems
VRF 3-way 12 systems
Indoor Units: 283 units
Cooling Capacity:
1,605 kW / 456 USRT

SCHOOL

United States Shippensburg University



Air Conditioning System:
VRF 3-Way MF1 series 55 systems
Indoor Units: 530 units
Cooling Capacity:
1,498 kW / 426 USRT

SCHOOL

Malaysia Xiamen University



Air Conditioning System:
VRF FSV Systems 110 systems
Indoor Units: 1,349 units
Cloud adapter: CZ-CFUSCC1 17 pcs

Russia Technopark of Nobosibirsk Academgorodok



Air Conditioning System:
VRF 2-way ME1 series 38 systems,
VRF 3-way 12 systems
Indoor Units: 234 units
Cooling Capacity:
1,487 kW / 422 USRT

HOSPITAL

Indonesia Bekasi Hospital



Air Conditioning System:
VRF 2-way FSV ME1 series 42 systems
Indoor Units: 283 units
Cooling Capacity:
1,834 kW / 524 USRT

Indonesia Persada Hospital



Air Conditioning System:
VRF 2-way FSV ME1 series 21 systems
Indoor Units: 116 units
Cooling Capacity:
989 kW / 281 USRT

HOSPITAL

France Clinique Dentaire Ablis (Dental Clinic)



Air Conditioning System:
mini VRF 2-way mini FSV LE1 series 3 systems
Cooling Capacity:
36.3 kW / 10.3 USRT

RESIDENTIAL

China Star River Group Luxury Condominium



Air Conditioning System:
VRF Master series 966 systems
Indoor Units: 3,948 systems
Cooling Capacity:
16,737 kW / 4,755 USRT

Singapore Punggol Eco-Town



Air Conditioning System:
Inverter multi-split room air conditioner
Indoor Units:
Wall mounted S series (with Ecovavi)
Control System: Panasonic HEMS

Hong Kong Gloucester Road Project



Air Conditioning System:
VRF FSM LA1 series 67 systems
Twenty series 105 systems
Indoor Units: 255 units
Cooling Capacity: 1,391 kW / 395 USRT

Hong Kong The Green Project



Air Conditioning System:
VRF FSM LA1 series 239 systems
Twenty series 538 systems
Indoor Units: 999 units
Cooling Capacity:
6,425 kW / 1,825 USRT

India Royal Orchids Eco-Green Homz



Air Conditioning System:
VRF 2-way FSV ME1 series 22 systems
Indoor Units: 139 units
Cooling Capacity:
802 kW / 228 USRT

India Heera Windfaire



Air Conditioning System:
VRF 2-way FSV ME1 series 96 systems,
VRF 3-way 12 systems
Indoor Units: 479 units
Cooling Capacity: 2,184kW / 620 USRT

Panama Mosaic Building PANAMA PACIFICO



Air Conditioning System:
VRF 2-way FSV LE1 series 156 systems
Indoor Units: 357 units
Cooling Capacity: 2,338 kW / 664 USRT