

<https://eu.datanavi.ac.smartcloud.panasonic.com/documents/>



## Installation Instructions Zone Control Box

Model No. **CZ-CAPZ1S**  
**CZ-CAPZ1M**

### Safety Precautions

#### Please Read Before Starting

- This Zone Control Box must be installed by the sales dealer or installer. This information is provided for use only by authorized.
- These instructions are all you need for most installation sites and maintenance conditions. If you require help for a special problem, contact our sales/service outlet or your certified dealer for additional instructions.
- We assume no responsibility for accidents or damages resulting from methods other than those described in the Installation Instructions or methods using unspecified parts. Malfunctions that occur due to unauthorised installation methods are not covered by the product warranty.
- Zone Control Box must be installed in accordance with National Wiring Regulations.
- When relocating or repairing Zone Control Box, provide the Installation Instructions to the servicing personnel.
- Please provide this Installation Instructions to the user after installation. Instruct user to keep it in a safe place along with the air conditioner instruction manuals.
- The product meets the technical requirements of EN/IEC 61000-3-3.
- This product is intended for professional use. Permission from the power supplier is required when installing the CZ-CAPZ1S, CZ-CAPZ1M that is connected to a 16 A distribution network.
- Read the Installation Instructions supplied with indoor units and outdoor units as well.

	<b>WARNING</b>	This symbol refers to a hazard or unsafe practice which can result in severe personal injury or death.
	<b>CAUTION</b>	This symbol refers to a hazard or unsafe practice which can result in personal injury or product or property damage.
	Prohibited matters	

### WARNING



Electrical shock can cause severe personal injury or death.

Only a qualified, experienced electrician should attempt to wire this system.

- Highly dangerous electrical voltages are used in this system. Carefully refer to the wiring diagram and these instructions when wiring. Improper connections and inadequate grounding can cause **accidental injury or death**.
- Zone Control Box is strongly recommended to be installed with Earth Leakage Circuit Breaker (ELCB) or Residual Current Device (RCD). Otherwise, it may cause electrical shock and fire in case of equipment breakdown or insulation breakdown. Earth Leakage Circuit Breaker (ELCB) must be incorporated in the fixed wiring in accordance with the wiring regulations. The Earth Leakage Circuit Breaker (ELCB) must be an approved 10 A, having a contact separation by 3 mm in all poles.
- To reduce the risk of electric shock, smoke, or fire, install a circuit breaker and earth leakage protective device.
- Turn off the circuit breaker of the units before installation or servicing.
- Provide a power outlet to be used exclusively for Zone Control Box.
- Do not supply power to the unit until all wiring is completed or reconnected and checked.
- To prevent possible hazards from insulation failure, the unit must be grounded. 
- Do not set up in hospitals or places where electronic medical devices are located.
- Zone Control Box must be securely installed in accordance with the Installation Instructions.
- Use only the parts specified by Panasonic as supplied accessories.
- Select an installation location which is rigid and strong enough to support or hold Zone Control Box, and select a location for easy maintenance.
- No disassembly or modification of this Zone Control Box is allowed under any circumstances.
- Electric work must be performed by authorised personnel in accordance with the local regulations and the instructions detailed in the Installation Instructions.
- Terminal block cover panel of the Zone Control Box must be firmly fixed. If the cover panel is mounted improperly, dust and moisture may enter the Zone Control Box, and it may cause electric shock or fire.
- Do not operate with wet hands.
- In case of an abnormal condition (such as a burning smell), turn the breaker OFF.
- When installing the Zone Control Box, use appropriate protective equipment and tools for safety.

# Safety Precautions

## ⚠ CAUTION

- Ground yourself to discharge static electricity before performing any wiring.
- Do not use in special environments. Use in places with much oil (including machine oil), steam, flammable or corrosive gas, voltage fluctuation, surrounding the metal body, may lead to severe decrease in functionality and damage to parts.
- Do not install the Zone Control Box in places with direct sunlight.
- Do not set up where children can reach Zone Control Box.
- Do not install the Zone Control Box in outdoor location as it is designed for indoor installation only. Otherwise, electric shock or breakdown may be caused by water drop, wind or dust.
- The Zone Control Box has signal outputs for damper motors however it can not isolate power to them in the event of overheating. All damper motors connected to the Zone Control Box must comply with National regulation.
- Do not connect the ground wire to gas or water pipes, lightning rods, or telephone grounding lines. If the Zone Control Box is not properly grounded, there may be a risk to get an electric shock.
- Be sure to safely dispose of the packaging materials. Packaging materials, such as nails and other metal or wooden parts may cause injuries.
- Zone Control Box must be powered off when changing or connecting damper motor.
- Turn the power OFF at the main power box (mains), wait at least 5 minutes until it is discharged, then open the unit to check or repair electrical parts and wiring.
- Be fully careful when moving the Zone Control Box. Do not hold the packaging bands. Wear protective gloves to unpack and to move it, in order to avoid your hands be injured by parts.

## Precautions

- Do not install Zone Control Box on top of the indoor unit.
- Regulations on wire diameters differ from locality to locality. For field wiring rules, please refer to your LOCAL ELECTRICAL CODES before beginning.
- You must ensure that installation complies with all relevant rules and regulations.
- Connect all wiring tightly to prevent the terminal board from loosening when the wiring connection part is pulled by an external force. (Otherwise, fire or overheating may occur.)
- To prevent malfunction of Zone Control Box caused by electrical noise, the remote control wiring and the zone control wiring should be wired apart from the power supply cable.

## Note

- The warranty does not cover the product if it falls from an elevated location.
- Please write down the model information and more on the "Installing record"(P.6), when you install the Zone Control Box.

# Contents

<b>Safety Precautions</b> .....	<b>1</b>
<b>Supplied accessories</b> .....	<b>2</b>
<b>Dimension</b> .....	<b>2</b>
<b>System Overview</b> .....	<b>3</b>
• Zone system outline .....	3
• Wiring Diagram .....	3
• Component parts .....	3
• Duct design .....	3
<b>Mounting</b> .....	<b>4</b>
<b>Electrical Wiring</b> .....	<b>4</b>
• General precautions on wiring .....	4
• Wire length and wire diameter .....	5
• Wiring system diagram .....	5
• Wiring sample .....	5
• How to connect wiring to the terminal .....	5
• Power supply wiring .....	5
• AC24 V wiring .....	6
• Connecting to indoor unit .....	6
• RC1/RC2 terminal board .....	6
• Damper motor wiring .....	6
<b>Installing record</b> .....	<b>6</b>
<b>Setting</b> .....	<b>7</b>
• Maintenance func .....	7
<b>Zone Setting</b> .....	<b>8</b>
<b>Sensor test</b> .....	<b>9</b>
<b>Test run</b> .....	<b>9</b>
<b>Troubleshooting</b> .....	<b>10</b>
<b>Self-diagnostics table</b> .....	<b>11</b>
<b>Specifications</b> .....	<b>11</b>

# Supplied accessories

( ): Number of pieces

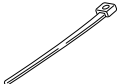

Installation Instructions (1)		Clamper (7)	
-------------------------------	---	-------------	---

\*Screws, wires, transformer, and damper motor not supplied. (Field supplied item)

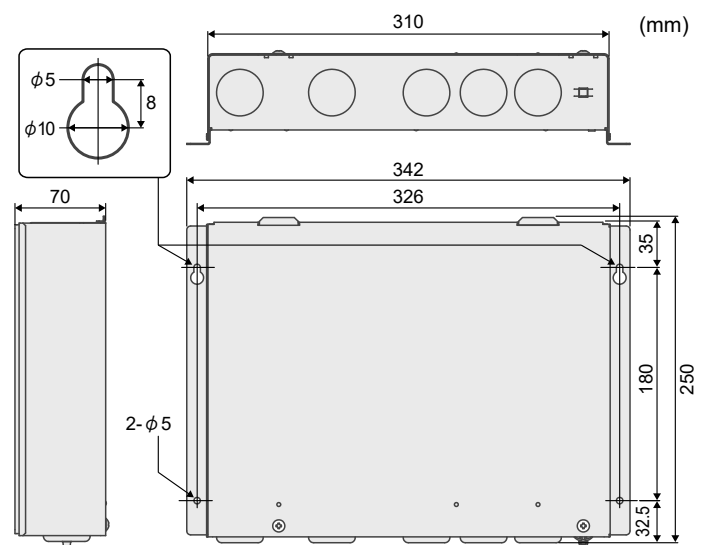
# Dimension



## Symbols on the controller

-  This symbol refers to "Protective earth".
-  This symbol refers to "Functional earthing".

# System Overview

## Zone system outline

- Refer to the following information to design a zone system that uses this Zone Remote Controller. This diagram shows an example of a system that has 4 damper motors, 2 Zone Remote Controllers, and 2 Remote Sensors connected. The Zone no. and Outlet combination is the factory default. The Zone no. and Outlet combination can be changed.

### NOTE

- This zone system has been designed for Panasonic ducted indoor units. Consult the place of purchase for supported models.

### • When common zone is to be used

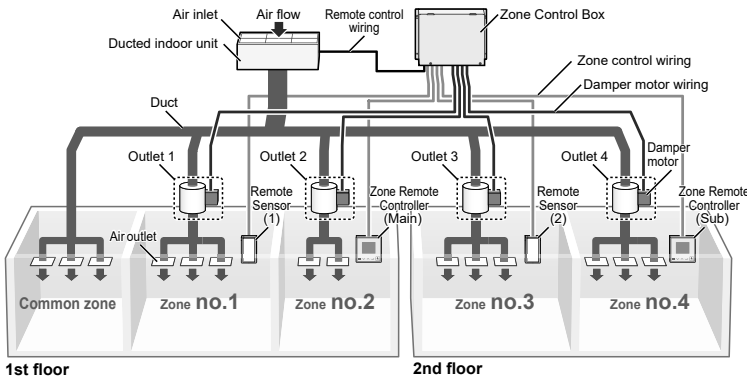

### • When spill zone is to be used

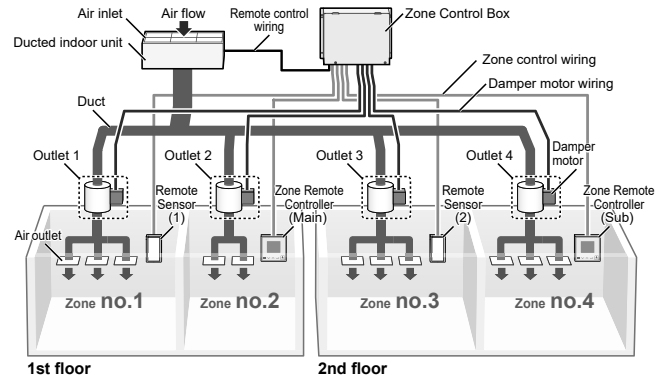

### NOTE

- Make sure a common zone is installed.
- Design ducting so that it is within the range of use on the PQ diagram of the indoor unit whether the damper motors are open or closed. Also refer to the duct design.

### NOTE

- Make sure there is at least one spill zone installed. Refer to "Zone Setting" (P.8) for how to set spill zones.
- Design ducting so that it is within the range of use on the PQ diagram of the indoor unit whether the damper motors are open or closed. Also refer to the duct design.
- A common zone cannot be used at the same time. Do not install a common zone.

## Wiring Diagram

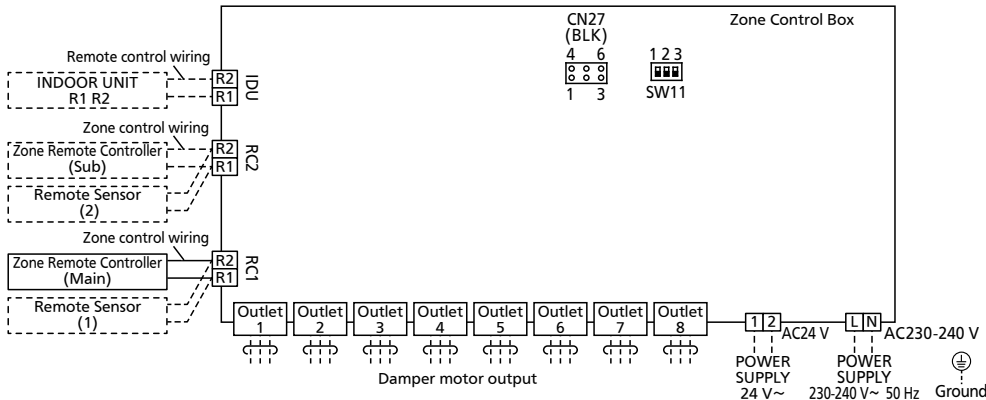

### NOTE

- Make all DIPSW (SW11) OFF and all jumper pins (CN27) OPEN. (Factory default) (Do not change the settings from the factory defaults. Proper operation is not possible if the settings are changed.)

## Component parts

- Check the following pieces of connected items before putting together the system.
  - Zone Control Box : Use either CZ-CAPZ1M (multiple opening step model) or CZ-CAPZ1S (on/off model).
  - Zone Remote Controller : A maximum of 2 Zone Remote Controllers can be connected. At least 1 Zone Remote Controller needs to be connected to an RC1 terminal board.
  - Remote Sensor : A maximum of 2 Remote Sensors can be connected.
  - Damper motor : Only drive open, drive close damper motor can be connected. (Spring motor damper can not be used.) A maximum of 8 can be connected.
  - Transformer : Use models suited to the damper motors.

## Duct design

- See the Installation Instructions for the ducted indoor units.
  - For the PQ diagram, refer to the Installation Instructions for the ducted indoor units.
  - When using a spill zone, pay attention to the following when designing ducting.
    - Depending on the open or closed state of the Zone, the Spill zone may close. The Spill zone may close in the following cases:
      - CZ-CAPZ1S : When the number of open zones is greater than the number of spill zones
      - CZ-CAPZ1M : When the total of steps (%) of open zones is greater than the number of spill zones × 100 (%)
- Refer to "Installing record" (P.6) for spill zone operating specifications.

## CAUTION

- Install the damper motors in locations where they cannot be easily touched.
- Design ducting so that it is within the range of use on the PQ diagram of the indoor unit whether the damper motors are open or closed. (If used outside of the range of use on the PQ diagram, there is the possibility of major abnormalities occurring with the devices, including motor malfunctions and water leakages.) Refer to "Zone Setting" (P.8) for how to set spill zones.

# Mounting

## •Mounting Position

- Secure space as shown below when mounting 2 or more of this Zone Control Box or mounting other devices side by side.

- Up, down, left and right direction: 100 mm or more
- Front: 50 mm or more

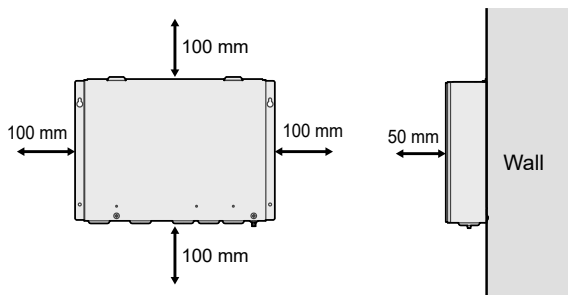

Do not install horizontally

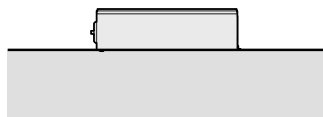

## •How to Mount

1. Attach the Zone Control Box to a wall surface, etc., and secure firmly with screws(field supply).
2. Remove the upper cover.
3. When wiring is complete, attach the upper cover and secure in place with screws.

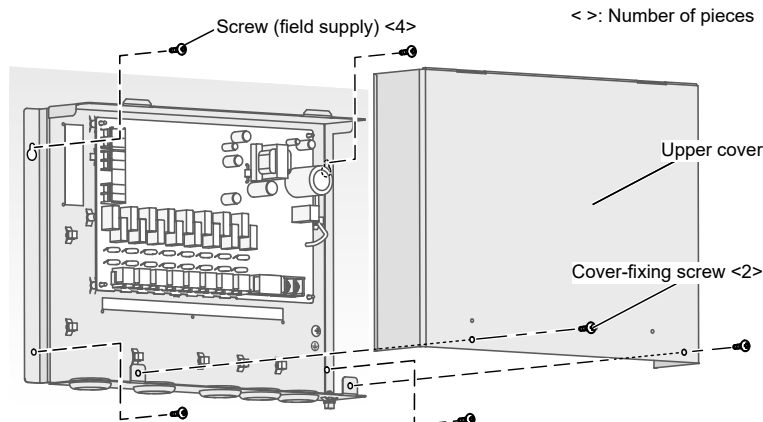

### NOTE

- Select the correct screws to ensure that the Zone Control Box does not fall from the installed location, securing the Zone Control Box an appropriate installation location.
- The Zone Control Box has been designed for installation indoors, so do not install outdoors.(The circuit board and casing of the Zone Control Box are not water proof.)
- Avoid situations where the Zone Control Box can be exposed to direct sunlight and other sources of heat.
- Select a location that enables easy wiring to a power source.
- Avoid locations where flammable gases may leak, be generated, flow, or accumulate.
- Select a location that is level and that can bear weight and prevent vibrations.
- Avoid locations exposed to oils, steam, and sulphurous gases.
- Do not install the Zone Control Box on top of an indoor unit.
- Avoid locations where get wet with water.

# Electrical Wiring

## General precautions on wiring

- (1) Before wiring, confirm the rated voltage of the unit as shown on its nameplate, then carry out the wiring closely following the wiring diagram.

### WARNING

- (2) This equipment is strongly recommended to be installed with Earth Leakage Circuit Breaker (ELCB) or Residual Current Device (RCD). Otherwise, it may cause electrical shock and fire in case of equipment breakdown or insulation breakdown. Earth Leakage Circuit Breaker (ELCB) must be incorporated in the fixed wiring in accordance with the wiring regulations. The Earth Leakage Circuit Breaker (ELCB) must be an approved 10 A, having a contact separation by 3 mm in all poles.
- (3) To prevent possible hazards from insulation failure, the unit must be grounded.

- (4) Each wiring connection must be done in accordance with the wiring system diagram. Wrong wiring may cause the unit to misoperate or become damaged.
- (5) Do not allow wiring to touch the refrigerant tubing, compressor, or any moving parts of the fan.
- (6) Unauthorized changes in the internal wiring can be very dangerous. The manufacturer will accept no responsibility for any damage or misoperation that occurs as a result of such unauthorized changes.
- (7) Regulations on wire diameters differ from locality to locality. For field wiring rules, please refer to your LOCAL ELECTRICAL CODES before beginning. You must ensure that installation complies with all relevant rules and regulations.
- (8) There is risk of damaging the screw if the terminal screw is over tightened. Tighten with the appropriate torque.

Item	Screw diameter name	Tightening torque N·m {kgf·m}
Power supply terminal board	M4	1.0-1.4
AC24 V terminal board		
Protective earth screw		
IDU terminal board	M3.5	0.6-1.0
RC1/RC2 terminal board		

## Wire length and wire diameter

- Two types are used; the power supply cable (B) and the control wiring (C).
- Power supply

(B)Power supply	Time delay fuse or circuit capacity
2 mm <sup>2</sup> (Min. 2 mm <sup>2</sup> )	
Max. 30 m *	

\*Maximum length shows 2 % voltage drop.

- Remote control wiring & Zone control wiring
- No polarity

(C)Remote control wiring & Zone control wiring
0.75 mm <sup>2</sup> to 1.25 mm <sup>2</sup> (Min. 0.75 mm <sup>2</sup> )
Max. 50 m for each of the 5 lengths of (C)

### NOTE

- With ring-type wire terminal.

## Wiring system diagram

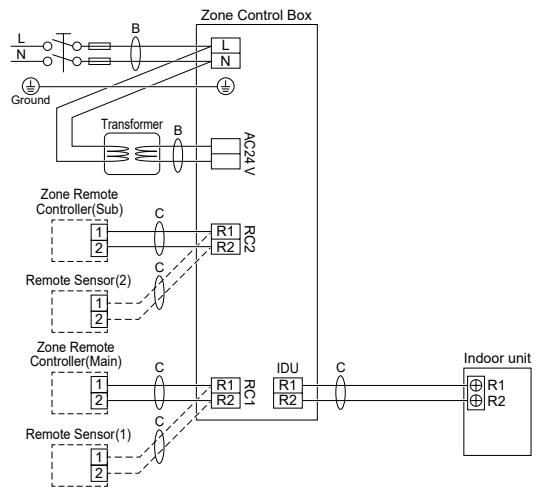

## Wiring sample

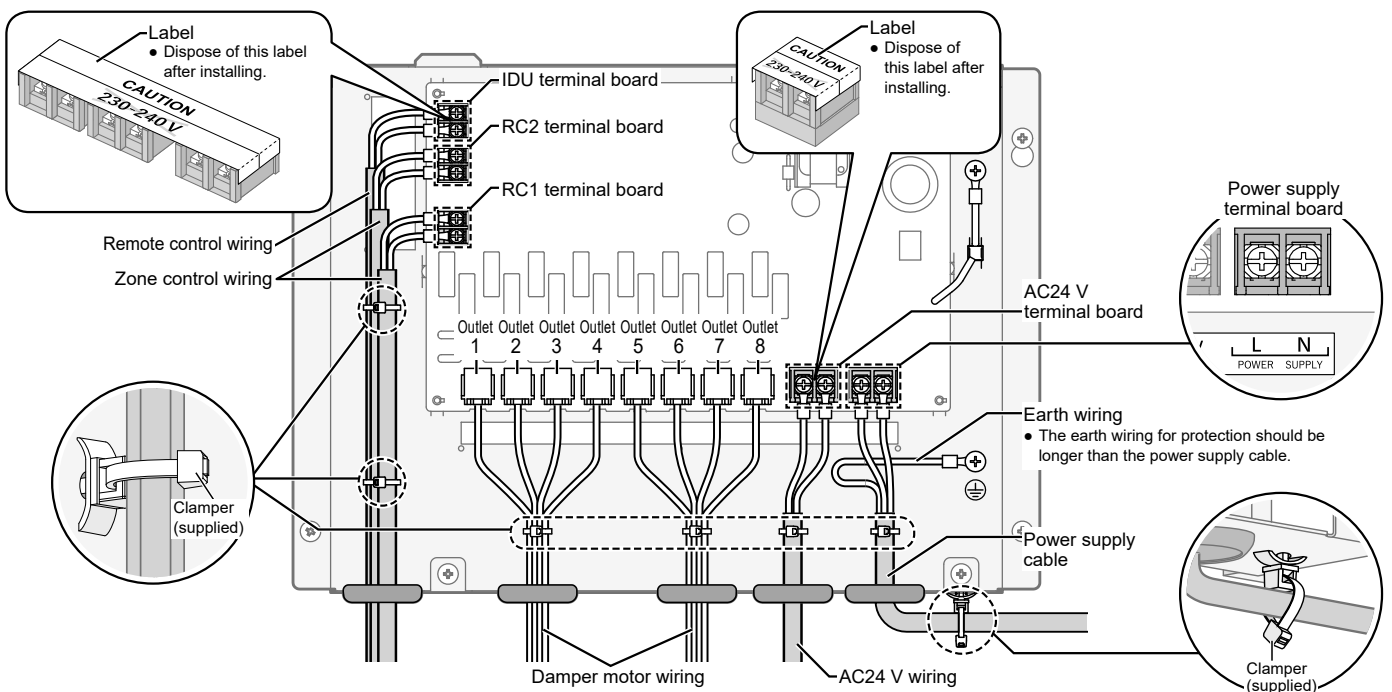

## How to connect wiring to the terminal

### How to attach the ring pressure terminal

1. Cut the wire end with cutting pliers, then strip the insulation to expose the stranded wiring about 10 mm and tightly twist the wire ends.

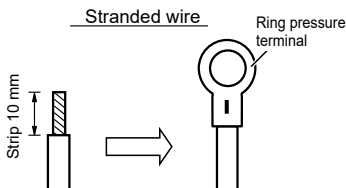

2. Using a ring connector fastener or pliers, securely clamp each stripped wire end with a ring pressure terminal.
3. Using a Phillips head screwdriver, remove the terminal screw(s) on the terminal board.
4. Place the ring pressure terminal, and replace and tighten the removed terminal screw using a screwdriver.

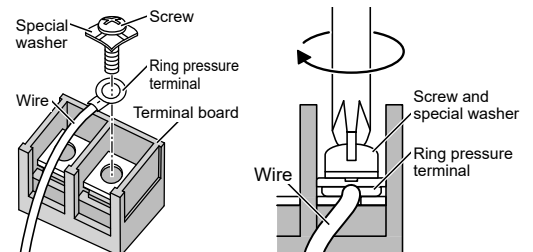

## Power supply wiring

Use the power supply cable (B) to connect 240V~ from the breaker.

\* Refer to "Wire length and wire diameter" for information about (B).

### CAUTION

- Be sure to earth this controller.
- Do not connect the earth wiring to those of gas pipe, water pipe, lighting rod, telephone, etc.

# Electrical Wiring

## AC24 V wiring

Use the power supply cable (B) to connect from the transformer to the AC24 V terminal board. The transformer is a field supplied item.  
\* Refer to "Wire length and wire diameter"(P.5) for information about (B).

## Connecting to indoor unit

Connect the IDU terminal board and the R1/R2 terminal board on the indoor unit with remote control wiring (C).  
\* Refer to "Wire length and wire diameter" for information about (C). Only indoor units can be connected to the IDU terminal board.

### NOTE

- Zone Remote Controllers and Remote Sensors cannot be connected to indoor units.
- Multiple Zone Remote Controllers or Remote Sensors cannot be connected to a single RC1/RC2 terminal board.
- Refer to the Installation Instructions supplied with the Remote Sensor for the installation location and mounting of the Remote Sensor. Refer to these Installation Instructions for Wiring for the Remote Sensor.

## RC1/RC2 terminal board

Use Zone control wiring(C) to connect the Zone Remote Controller or Remote Sensor.  
\* Refer to "Wire length and wire diameter"(P.5) for information about (C). Connect 1 Zone Remote Controller and 1 Remote Sensor to a single RC1/RC2 terminal board.  
The Zone Remote Controller connected to the RC1 terminal board will become the Main.  
The Zone Remote Controller connected to the RC2 terminal board will become the Sub.  
Only CZ-RTC6Z and CZ-CSRC3 can be connected to the RC1 / RC2 terminal board.

## Damper motor wiring

- Connect the damper motor cable to Outlet 1-8. The damper motor is a field supplied item. Refer to the following table and connect the cable to the correct Outlet. Use a cable with suitable pin allocations.
- External outputs

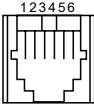
Name	Item	Connector type
Outlet 1	Damper motor output 1	PIN1,2 : OPEN PIN3 : COM PIN5,6 : CLOSE 
Outlet 2	Damper motor output 2	
Outlet 3	Damper motor output 3	
Outlet 4	Damper motor output 4	
Outlet 5	Damper motor output 5	
Outlet 6	Damper motor output 6	
Outlet 7	Damper motor output 7	
Outlet 8	Damper motor output 8	
AC24 V	24 V~ damper source supply	No polarity

### NOTE

- When connecting damper motors, be sure to connect in order from Outlet 1.

- Confirm that the damper motor and damper motor cable you are using both meet the following specifications.

### Damper motor & damper motor cable

Specification		
Damper motor	Voltage	24 V~
	Frequency	50-60 Hz
	Maximum Operation Current (per damper)	360 mA or less
	Maximum Electric Power (per damper)	7 VA or less
Damper motor cable	Wire diameter (mm <sup>2</sup> )	0.48 mm <sup>2</sup> or more (Min. 0.48 mm <sup>2</sup> )
	Maximum wiring length	30 m or less
	Type	RJ12 6-poler, 6-core
Transformer	Input Voltage	240 V~
	Output Voltage	24 V~

## ! WARNING

- The damper motors and transformers must conform to the regulations of the locality they are being used in.
- Use a transformer that has an internal fuse.
- To select a transformer suits the specifications of the damper motor and damper motor cable as per table above.
- To select a transformer VA that is at least 1.5 times the total maximum VA for all dampers motors combined.

## Installing record

This section is information required for Zone Setting (P.8).  
Decide the Option and Outlet to use before setting.  
For CZ-CAPZ1S, the number of open zones is less than the number of spill zones, and the spill zone will be automatically opened.  
For CZ-CAPZ1M, the total of steps (%) of open zones is less than the number of spill zones x100 (%), and the spill zone will be automatically opened.  
Spill zones that automatically open are opened starting at the zone with the smallest zone number.  
Refer to "Zone Setting" (P.8) for how to set spill zones.

Option setting	With or without	Name
Zone Remote Controller (Main)		
Zone Remote Controller (Sub)		
Remote Sensor(1)		
Remote Sensor(2)		

Outlet setting	Zone no.	With or without	Name	Open close time	Linking sensor	Spill zone
Outlet 1						
Outlet 2						
Outlet 3						
Outlet 4						
Outlet 5						
Outlet 6						
Outlet 7						
Outlet 8						
Common zone	-		-	-	-	-

# Setting

**Preparation:** Confirm that the outdoor unit, indoor unit, Zone Remote Controller, and Zone Control Box have each been installed according to the procedures laid out in their Installation Instructions. Turn on the power of the outdoor unit, indoor unit, and Zone Control Box. Wait until the Zone Remote Controller starts and the [Assigning] screen disappears.  
(If [Assigning] continues to blink for more than 10 minutes, check the address settings for the indoor unit.)

## Maintenance func

- RC. setting mode ■ Auto address ■ Detailed settings ■ Sensor info. ■ Service check ■ Set elec. consumption

Check this item as necessary.  
Steps 1 and 2 are common operations for each item.

**1 Press and hold the 3 buttons simultaneously, for at least 4 seconds.**

Press , , .



**2 Select the item to set.**

Press → .

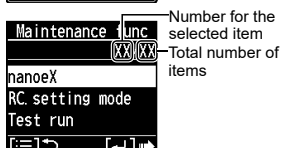

### RC. setting mode

**3 Set.**  
(Select the Code no. and Set data.)  
Press → .(Repeat)

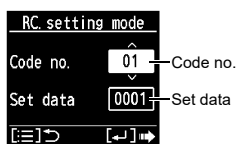

**4 Press .**  
• After Selecting [YES], the unit restarts.

Code no.	Set data
2F Password change	Set the administrator password. • 0000 to 9999 • 0000 (factory setting)

### Auto address (an air conditioner setting)

**3 Set.**  
(Select the Code no. [A1] and O/D unit no.)  
Press → .(Repeat)

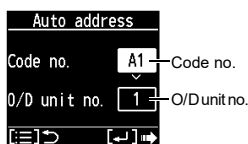

**4 Press .**  
• After Selecting [YES], the unit restarts.

Code no.	O/D unit no.
A1	Set the Auto address for each O/D unit no. Select the O/D unit no. (outdoor unit) for Auto address. • Outdoor unit number

#### Attention

- Set Auto address after all units are turned on and 90 seconds or more have passed.
- Operate the units after Auto address is set and 90 seconds or more have passed.

### Detailed settings (an air conditioner setting)

**3 Set.**  
(Select the indoor unit number, Code no. and Set data.)  
(When selecting Code no., refer to the following table.)  
Press → .(Repeat)

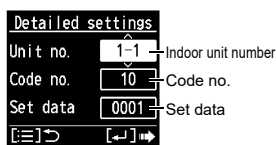

**4 Press .**  
• After Selecting [YES], the unit restarts.

Code no.	Set data
31 Vent output setting	Set this when connecting a commercially sold fan, etc. to the ventilation fan output "FAN DRIVE:2P (White)" on the indoor control board. *Dedicated cables (optional) are required. • 0000: Not connected • 0001: Connected

\* Depending on the type of indoor unit, Code no. may be displayed with 6 digits. In this case, read as follows.  
e.g. 000031→31

### Sensor info. (an air conditioner setting)

This displays each sensor temperature of the remote controller, indoor units and outdoor units.

**3 Select.**  
(Select the unit number and Code no.)  
Press → .(Repeat)

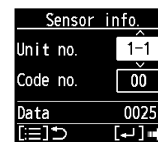

**4 Confirm the content.**

Press .

Pressing will return to the Maintenance func screen.

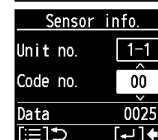

### Service check (an air conditioner setting)

This displays the alarm history.

**3 Confirm the content.**

Press .

Information of the last 4 alarms is displayed.  
[-] shows that no alarm has occurred.

- Pressing will return to the Maintenance func screen.
- To delete the alarm history, press and select [YES].

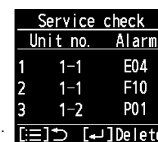

### Set elec. consumption (an air conditioner setting)

**3 Set.**  
(Select the power supply voltage of outdoor units.)  
Press → .

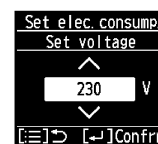

**4 Select [YES].**

#### NOTE

- Set the power supply voltage of outdoor units to calculate electric consumption of the Power consumption monitor.
- If the setting differs from the power supply voltage of outdoor units, the electric consumption value of the Power consumption monitor will differ from the actual calculation result by a power meter.
- Depending on the outdoor unit model, this cannot be set.

#### • When 3-phase model connections are used for outdoor units

Power supply voltage	Setting value
380 V	220 V
400 V	230 V
415 V	240 V

# Zone Setting

- Enable/disable ■ Options ■ Zone initial ■ Common/Spill ■ Spill zone ■ Damper motor time ■ Damper test

This section includes information regarding settings made during installation. Perform the settings after carefully reading the instructions. Steps 1, 2 and 3 are common operations for each item.

**1 Press and hold the 3 buttons simultaneously, for at least 4 seconds.**

Press , , .



**2 Select the [Zone settings] to set.**

Press → .



Number for the selected item  
Total number of items

**3 Select the item to set.**

Press → .

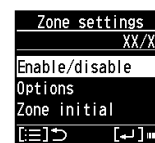

**4 Use the following procedure to make the settings for Select the item.**

## Enable/disable

Set enable/disable for Zone no. 1 to 8.

Set  for Zone no. to be enabled.

**Select.**

(Select the Zone no.)

Press → .(Repeat)

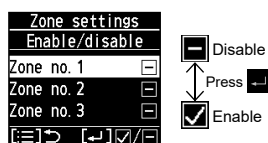

## Options

Set  for the Option to be enabled.

**Select.**

(Select the option.)

Press → .(Repeat)

- Sub RC : Zone Remote Controller(Sub)
- Sensor1 : Remote Sensor(1)
- Sensor2 : Remote Sensor(2)

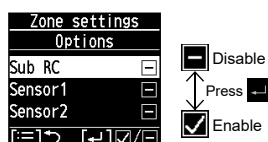

## Zone initial

Allocate outlet and sensor to the Zone no. that you enabled.

**Select the Zone no., Outlet, Sensor.**

Press → .(Repeat)

• Sensor selection items

• Default setting : No use

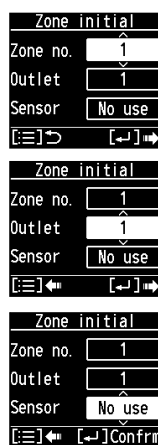
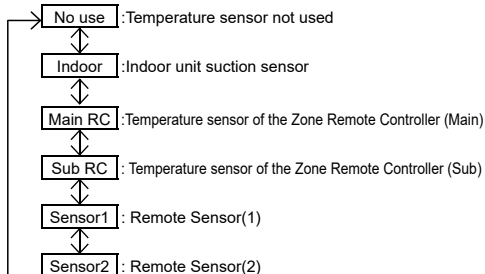

### Attention

- You cannot select Zone no. for which you have not set  for [Enable/disable].
- [--] is displayed when not even one Zone no. has been enabled. Enable the Zone no. to be used with [Enable/disable].

## Common/Spill

When using a common zone, select "Common"; when using a spill zone, select "Spill".

**Select.**

(Select the Spill/Common)

• Default setting : Unset

Spill When spill zone is to be used

Common When common zone is to be used

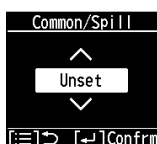

### Attention

- The Unset setting cannot be used.
- You must set either Spill or Common.

## Spill zone

Select the Zone no. to be set for the Spill zone.

Put the  next to the Zone no. to be made the spill zone.

**Select.**

(Select the Zone no.)

Press → .(Repeat)

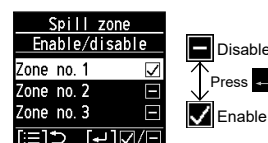

### Attention

- This must be set if a spill zone is to be used.
- When you make the Common/Spill setting Spill, you can then make the spill zone settings.
- Make sure there is at least one spill zone set.
- You cannot select Zone no. for which you have not set  next to [Enable/disable].
- [--] is displayed when not even one Zone no. has been enabled. Enable the Zone no. to be used with [Enable/disable].

## Damper motor time

Set the opening/closing times for the damper motors in each Zone no. Check the damper motor specifications when setting the damper motor opening/closing times. If the damper motor opening/closing times are unknown, use [Damper test] to check the opening/closing times, and then make the settings. When ALL is selected in Zone no., you can set them all at the same time.

**Select.**

(Select the Zone no., ON[sec], OFF[sec])

Press → .(Repeat)

- ON [sec] : Damper motor fully open time (Default setting : 15.0[sec])
- OFF [sec] : Damper motor fully closed time (Default setting : 15.0[sec])

- Damper motor time can be set in increments of 0.1sec.
- Press and hold for at least 6 seconds, damper motor time can be set in increments of 1.0 sec.



### Attention

- If the damper motor times are not accurately set, the multiple opening step control will not be performed properly. (multiple opening step models only)
- If the damper motor times are not accurately set, opening and closing cannot be performed properly.
- When ALL has been selected in Zone no., the setting values for Zone no.1 are displayed.
- You cannot select Zone no. for which you have not set  for [Enable/disable].
- [--] is displayed when not even one Zone no. has been enabled. Enable the Zone no. to be used with [Enable/disable].

## Damper test

This is used to perform opening/closing tests for the damper motors. The damper motors open and close according to the times set in damper motor time.

**Select.**

(Select the Zone no., ON/OFF.)

Press → → .

- The damper motors open according to the times set in [Damper motor time] when ON is selected. The damper motors close according to the times set in [Damper motor time] when OFF is selected.



### Attention

- You cannot select Zone no. for which you have not set  for [Enable/disable].
- [--] is displayed when not even one Zone no. has been enabled. Enable the Zone no. to be used with [Enable/disable].



# Sensor test

You can confirm sensor operation with the following procedure.

## 1 Display the [ZONE] screen.

Press .

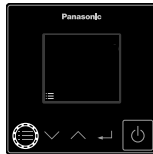

## 2 Select [Sensor].

Press , , .

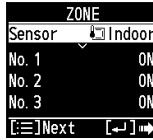

## 3 Check the temperature on each sensor.

Press , .

- Indoor : Indoor unit suction sensor
- Main RC : Temperature sensor of the Zone Remote Controller (Main)
- Sub RC : Temperature sensor of the Zone Remote Controller (Sub)
- Sensor1 : Remote Sensor(1)
- Sensor2 : Remote Sensor(2)

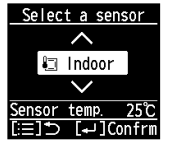

### Attention

- Other than the Indoor or Main RC sensors, sensors which have been enabled in [Options] can be selected.
- If the temperature is not displayed after waiting a while, check the remote control wiring or Zone control wiring for each of the sensors.

# Test run

## 1 Press and hold the 3 buttons simultaneously, for at least 4 seconds.

Press , , .

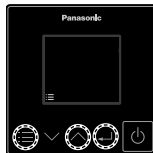

## 2 Select [Test run].

Press , , .

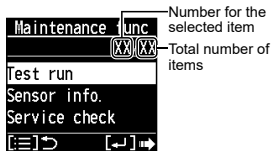

## 3 Select [ON].

(The unit enters the test operation mode. Then, [TEST] turns on.)

Press , , .



Press .





## 4 Display the [ZONE] screen.

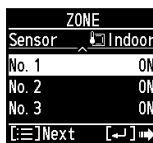

Press .

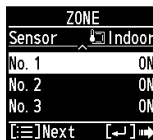

## 5 Fully open the damper motor.

Press ,  to select the Zone no. to open and then press .



Press ,  to select [ON] or [100%] and then press .



- CZ-CAPZ1S : Select [ON].
- CZ-CAPZ1M : Select [100%].

## 6 Perform the test operation.

Press .





## 7 Spill zone test operation

Make checks before using the spill zone.

Checks are not necessary when using a common zone, so proceed to Step 8.

Fully close the damper motor.

Press ,  to select the Zone no. to close and then press .

- Check whether the damper motor set for the spill zone automatically opens. "S" is displayed for spill zones that automatically open.

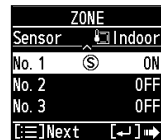

## 8 Finish the test operation.

Perform step 1 and 2, and then select [OFF] in step 3. ([TEST] display disappears.)

- The test operation can be performed in Heat or Cool mode.
- Temperature cannot be changed.
- The test operation mode is automatically turned off in 60 minutes. (To prevent continuous test operation)
- Outdoor units do not operate for approx. 3 minutes after the power is turned on or operation is stopped.

### Attention

- Do not use this mode for purposes other than the test operation. (To prevent overload of the units)
- Read the Installation Instructions supplied with the Air conditioner.

# Troubleshooting

If your air conditioner, damper motor and Zone Remote Controller does not work properly, first check the following points before requesting service. If it still does not work properly, contact your dealer or a service center.

Symptom	Cause	Remedy
Screen is not displayed on the Zone Remote Controller	The power of the Zone Control Box is OFF.	<ul style="list-style-type: none"> <li>•Check if the LED of the Zone Control Box is on.If the LED does not turn on, check whether the breaker is OFF.</li> <li>•If breaker has been tripped, consult your dealer without turning it on.</li> </ul>
	The Zone Remote Controller has not been wired correctly.	•Refer to "Wiring Diagram"(P.3) and check the Zone control wiring connections.
	The fuse of the Zone Control Box has blown.	•If blown out, consult your dealer.
[Assigning] appears blinking on the Zone Remote Controller screen continuously for over 10 minutes	Settings on the indoor unit and outdoor unit are not complete.	•See Installation Instructions of indoor units,"Service Manual", "Test Run Service Manual", "Technical Data".
	Indoor unit, Zone control Box, and Zone Remote Controller have not been wired correctly.	•Refer to "Wiring Diagram"(P.3) and check the connections of the devices.
A warning is displayed on the Zone Remote Controller	When the warning code starts with "Z"	•Warning code for the zone system. Refer to "Self-diagnostics table"(P.11).
	When the warning code does not start with "Z"	•Warning code for the air conditioner. •For how to handle the alarms, see Installation Instructions of indoor units, "Service Manual", "Test Run Service Manual" or "Technical Data".
Damper motor does not work	The power of the damper motor is OFF.	•Refer to "Wiring Diagram"(P.3) , and check the connections on the AC24 V terminal board and Damper motor output.
	The transformer has not been wired correctly.	•Refer to "Wiring Diagram"(P.3) and check the connections on the transformer.
	The damper motor cable does not have the correct specifications.	•Refer to "Damper motor wiring"(P.6) and check the specifications of the damper motor cable.
	The damper motor and transformer do not have the correct specifications.	<ul style="list-style-type: none"> <li>•Refer to "Damper motor wiring"(P.6) and check the specifications of the damper motor.</li> <li>•Select a transformer to conforms with the voltage values and current values of the damper motor.</li> <li>•Check the output voltage of the transformer.</li> <li>•Check if the damper motor is broken.</li> </ul>
	The Zone Control Box and damper motor combination has not been configured correctly.	<ul style="list-style-type: none"> <li>•Check against the content of "Installing record"(P.6) to check if connections have been done correctly.</li> <li>•Refer to "Zone Setting"(P.8) and check "Enable/disable" and "Zone initial".</li> </ul>
	The fuse of the Zone Control Box has blown.	•If blown out, consult your dealer.
	There is a problem with the damper motor and transformer.	•Replace the damper motor and transformer.
Air does not flow	The settings for the external static pressure are not correct.	•See Installation Instructions of indoor units, and confirm that they are being used within the range of the PQ diagram.
	The fan of the indoor unit is not operating.	•See Installation Instructions of indoor units,"Service Manual", "Test Run Service Manual", "Technical Data".

# Self-diagnostics table

The “Alarm display” shown in the table below expresses the alarm contents displayed for zone system.

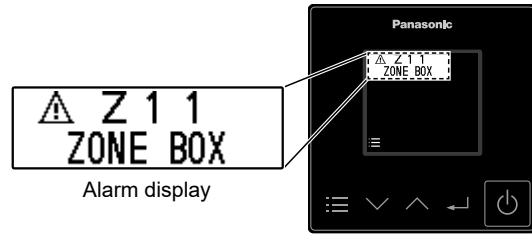

Alarm display	Alarm contents	Remedy
Z02	RC1 terminal board and RC2 terminal board are connected.	<ul style="list-style-type: none"> <li>•Refer to “Wiring system diagram”(P.5) and check the connections.</li> </ul>
Z03	RC1 terminal board and IDU terminal board are connected.	
Z04	RC2 terminal board and IDU terminal board are connected.	
Z05	RC1 terminal board, RC2 terminal board, and IDU terminal board are connected.	
Z06	Indoor unit is connected to the RC1 terminal board.	
Z07	Indoor unit is connected to the RC2 terminal board.	
Z08	Zone Remote Controller is connected to the IDU terminal board.	
Z09	2 Zone Remote Controllers are connected to the RC1 terminal board.	
Z10	2 Zone Remote Controllers are connected to the RC2 terminal board.	
Z11	There is no input to the AC24 V terminal board.	
Z12	There is an error in the EEPROM of the Zone Control Box.	
Z13	Multiple Zone Control Boxes have been connected to the zone system.	•Refer to “Wiring system diagram”(P.5) and check the connections.
Z14	There is a communication error between the Zone Control Box and indoor unit.	•Check the remote control wiring.
Z15	There is a communication error between the Zone Control box and Zone Remote Controller (Main).	<ul style="list-style-type: none"> <li>•Check the Zone control wiring.</li> </ul>
Z16	There is a communication error between the Zone Control box and Zone Remote Controller (Sub).	
Z17	There is a communication error between the Zone Control Box and Remote Sensor (1).	
Z18	There is a communication error between the Zone Control Box and Remote Sensor (2).	
Z19	There is a communication error on the Zone Remote Controller.	
Z20	There is an error in the Zone initial settings on the Zone Control Box.	<ul style="list-style-type: none"> <li>•The same Outlet is set in multiple Zone no.</li> <li>•Set Zone initial so that there is no duplication of the Outlet.</li> </ul>
Z21	Common/Spill is Unset.	•Refer to “Zone Setting” (P.8) and set Common/Spill.

If your zone system still does not work properly although you checked the points as described above, first stop the operation and turn off the power switch.

Then contact your dealer and report the serial number and symptom.

# Specifications

Model No.	CZ-CAPZ1S/CZ-CAPZ1M
Dimensions	(H) 250 mm × (W) 342 mm × (D)70 mm
Weight	1.9 kg

