

Dimensions

1. CW-U1021VPH / CW-U1221VPH

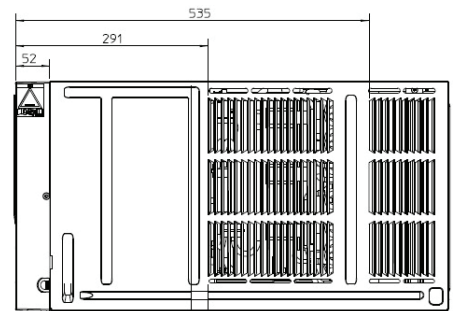
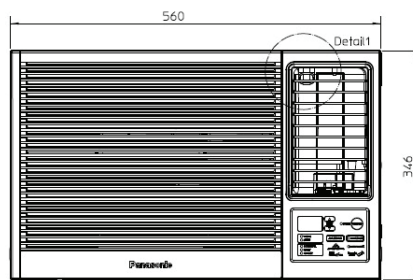
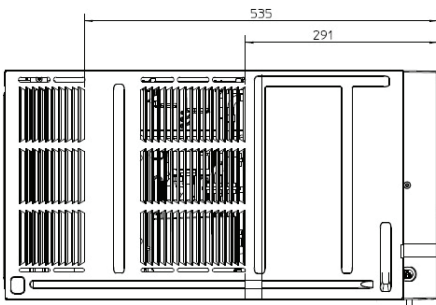
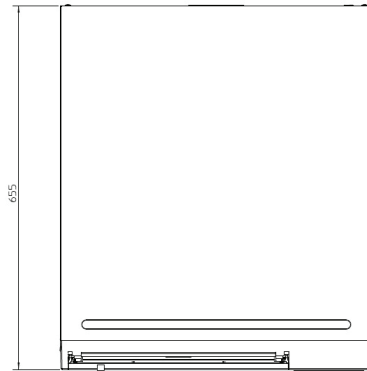

Dimensions

1. CW-U921JPH

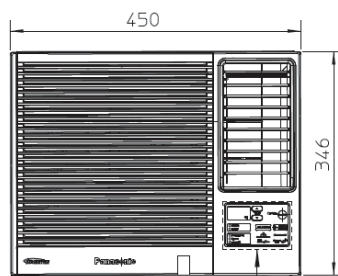
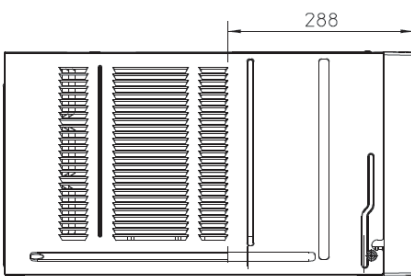
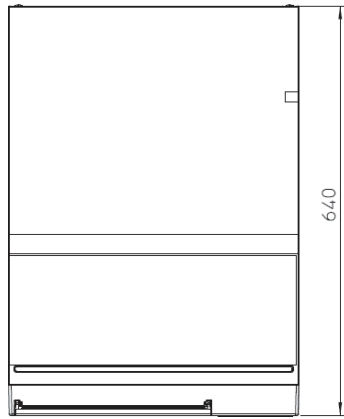

SEE DTL 1

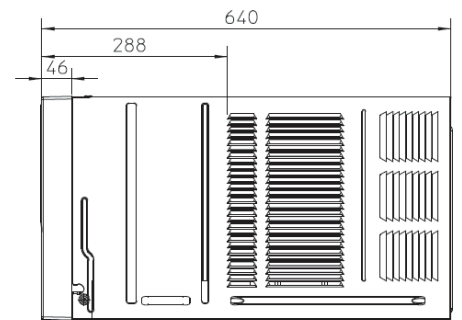

Dimensions

1. CW-U1821EPH

