

CZ - RD52CP

TABLE OF CONTENTS

Product Overview	2
Remote Control Preparation	3
Operations	4
How to Select the Timer	5
Daily Timer Setting	6
Weekly Timer Setting	7~8
Troubleshooting	8



© Panasonic HA Air-Conditioning (M) Sdn. Bhd. 2008.
Unauthorized copying and distribution is a violation of law.

Panasonic Corporation
Website: <http://panasonic.net/>

PRODUCT OVERVIEW

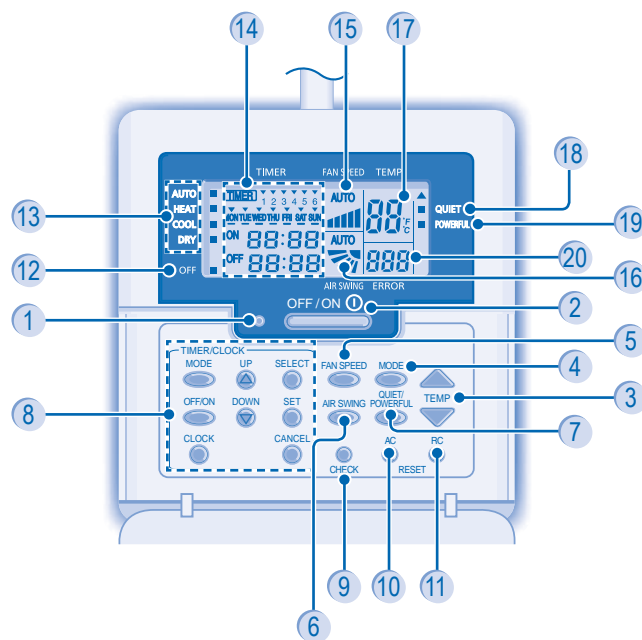

- | | |
|--------------------------------------|----------------------------------------|
| 1 Operation LED | 11 Remote Control Reset Button |
| 2 OFF/ON Button | 12 OFF Indicator |
| 3 Temperature Setting Button | 13 Operation Mode Selection Indicators |
| 4 Operation Mode Button | 14 Timer/Clock Setting Display |
| 5 Fan Speed Button | 15 Fan Speed Display |
| 6 Airflow Direction Selection Button | 16 Airflow Direction Setting Display |
| 7 Quiet/Powerful Operation Button | 17 Temperature Setting Display |
| 8 Timer Setting Button Group | 18 Quiet Operation Indicator |
| 9 Check Button | 19 Powerful Operation Indicator |
| 10 Air Conditioner Reset Button | 20 System Error Display |

REMOTE CONTROL PREPARATION

SETTING CURRENT DAY AND TIME

The current day and time need to be set when you turn on the power for the first time or after a long time has elapsed since the power was last turned on. The current time becomes the standard time for all the Timer operations. Set the current time and day accurately.

Example: Current Day is Wednesday and Current Time is 8:00

1 Turn on the power supply

2 Press

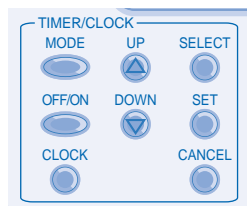

3 Select Current Day

Press or to select current day. (Refer to the above example; select WED)
To confirm the selected day, press .

4 Select Current Time

Press or to select current time. (Refer to the above example; select 8:00)
To confirm the selected time, press .

Note:

- Press to increase or to decrease (1-minute step) or hold the button to change the time faster.
- If or is not pressed for 30 seconds during the day or time setting or if is pressed, the setting at that moment is confirmed and setting will end.

Final CLOCK Display

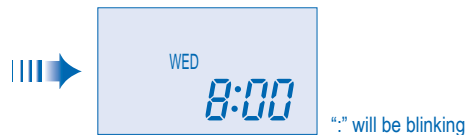

OPERATIONS

1 TO TURN ON OR OFF THE UNIT

- Please be aware of the OFF indication on the remote control display to prevent the unit from starting/stopping improperly.
- For normal operation, OFF indicator shown on remote control display when the unit is turn off.

2 TO SET TEMPERATURE

- Selection range: 16°C ~ 30°C.

3 TO SELECT OPERATION MODE

- AUTO mode - For your convenience**
 - Unit selects operation mode according to temperature setting, outdoor and room temperature.
- HEAT mode - To enjoy warm air**
 - Unit takes a while to warm up.
- COOL mode - To enjoy cool air**
- DRY mode - To dehumidify the environment**
 - Unit operates at low fan speed to give a gentle cooling operation.
 - During soft dry operation, the indoor fan operates at a low fan speed.
 - The louvers movement might not align with the remote control display.

4 TO SELECT FAN SPEED (5 options)



- For AUTO, the indoor fan speed is automatically adjusted according to the operation mode.

5 TO ADJUST VERTICAL AIRFLOW DIRECTION (5 options)



- Keeps the room ventilated.
- If AUTO is set, the louvers swing up/down automatically.
- In heat mode, the air blows horizontally for a while, then starts to blow downwards.

6

QUIET - TO ENJOY QUIET ENVIRONMENT

- This operation reduces airflow noise.

POWERFUL - TO ACHIEVE TEMPERATURE QUICKLY

HOW TO SELECT THE TIMER

2 types of Timer mode can be selected on the remote control.

- Daily Timer
- Weekly Timer
- Daily timer and weekly timer could not be set at the same time.
- Select one of these Timers for your convenience.

How to Change the Display

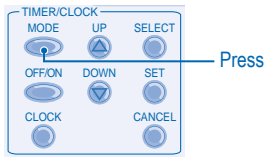

- Press once to change the display from CLOCK to Timer or vice-versa.
- Press for more than 4 seconds to change the display from Daily Timer to Weekly Timer or vice-versa.

Daily Timer Display

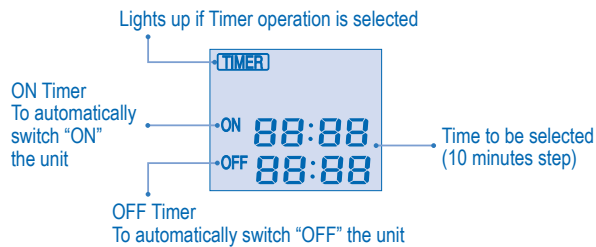

Weekly Timer Display

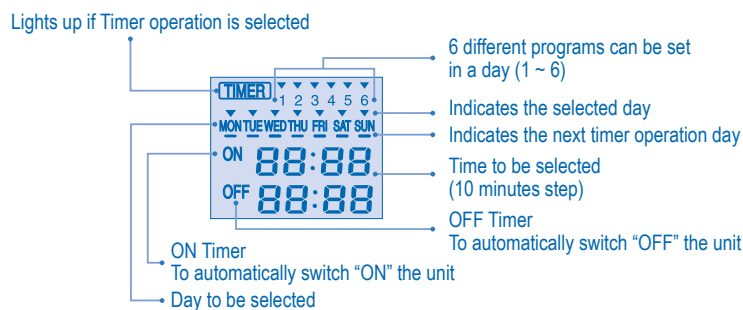

5

DAILY TIMER SETTING

How to Set Daily Timer

- You can set ON timer only or OFF timer only or both ON and OFF timer in a day.

1 Change Display

Press Timer to change the display to daily timer.

2 Press Timer to select ON or OFF timer.

Example: To turn ON the unit at 09:00

Press Timer to select ON timer.

Press to select the desired time, then press to confirm the selected time.

Or press if you do not want any setting for ON Timer.

Example: To turn OFF the unit at 18:30

Press Timer to select OFF timer.

Press to select the desired time, then press to confirm the selected time.

Or press if you do not want any setting for OFF Timer.

Note:

- When ON timer is set, the unit may start early before the actual set time in order to achieve the desired temperature on time.
- Timer operation is based on the clock set in the remote control and repeats daily once set. For clock setting, please refer to Remote Control preparation.
- The timer closest to the current time will be activated first.
- If timer is cancelled manually or due to power failure, you can restore the previous setting by pressing .

Final Display of Daily Timer:

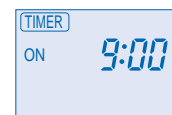

Only ON Timer is selected. The unit will automatically switch ON at 9:00.

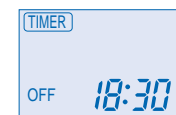

Only OFF Timer is selected. The unit will automatically switch OFF at 18:30.

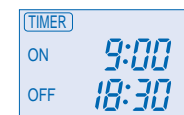

Both ON and OFF Timer are selected.

6

WEEKLY TIMER SETTING

How to Set Weekly Timer

- You can set the Timer for each day of the week (Monday to Sunday) with 6 programs per day.
- ON Timer can be set together with your desired temperature and this temperature will be used continuously.
- Same timer program cannot be set in the same day.
- You may also select collective days with same timer setting.
- Promotes energy saving by allowing you to set up to 6 programs in any given day.

Day and Timer Set Up Method

1. Press Timer for 4 seconds to change display to weekly timer.



2. Press Timer or to select your desired day.

3. Press to confirm your selection.

4. "1" will be blinking, press to set program 1.

5. Press Timer to select ON or OFF timer.

6. Press Timer or to select your desired time.

If you want to set the timer together with your desired temperature, press to select the temperature.

7. Press to confirm program 1. The selected day will be highlighted with .

- After 2 seconds, the display will move to the next program. Repeat steps 4 to 7 to set programs 2 to 6.
- During timer setup, if no button is pressed within 30 seconds, or if the button is pressed, the setting at that moment is confirmed and timer setup is ended.

Check Current Timer Program

Perform the steps below to check the timer program for a particular day.

1. Press Timer to enter timer mode.

2. Press to enter day setting.

3. Press Timer or until your desired day is shown, press to confirm your selection.

4. Press Timer or to check the set programs.

Modify Current Timer Program or Add New Timer Program

1. Press Timer to enter timer mode.

2. Press to enter day setting.

3. Press Timer or until your desired day is shown.

4. Perform steps 4 to 7 of "Day and Timer Set Up Method" to modify existing timer program, or add any timer program.

7

Cancel Current Timer Program

Perform the steps below to cancel the timer program for a particular day.

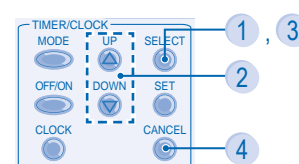

1. Press to enter day.
2. Press Timer or until your desired day is shown.
3. Press to enter program setting.
4. Press Timer or until your desired day is shown. Press to cancel the program, will disappear.

For example, if you want to set:

- A - Monday to Friday: Unit ON at 09:00 with 20°C (program 1) & unit OFF at 18:30 (program 2).
- B - Only Wednesday: Add timer to turn OFF the unit at 12:30 (program 3) and turn ON the unit at 13:30 (program 4).

To set A (Monday to Friday – Collective day setting)

To set the time, please refer to steps 1 to 7 of "Day and Timer Set Up Method" on page 7.
Program 1 – select ON, set desired time to 9:00 and desired temperature to 20°C.
Program 2 – select OFF and set desired time to 18:30.

Program 3 ~ 6 – no timer program set, press or wait 30 seconds to exit weekly timer.

To set B (Wednesday – add new timer program)

1. Press Timer to enter timer mode.
2. Press Timer to enter day setting.
3. Press Timer or until "WED" is selected, press to confirm your selection.
4. Perform steps 4 to 7 of "Day and Timer Set Up Method" to add program 3 and program 4.

Note: Timer that has setting nearest to the current time and day will be activated first.

Disable & Enable Weekly Timer

- To disable weekly timer setting, press , then press .
- To enable previous weekly timer setting, press , then press .

TROUBLESHOOTING

The following symptoms occur when abnormality occurs during operation.

- The unit stops and operation LED OFF.
- OFF indicator does not shown on remote control display.

When abnormality occurs, use remote control to retrieve error code.

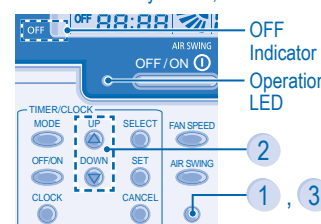

Ensure the operation LED is in OFF condition.

1. Press for 5 seconds.
2. Press or . If error code and abnormality can be identified, the operation LED will be ON continuously, then jot down the error code.
3. Press for 5 seconds to quit checking.
4. Reveal the error code to authorized dealer.

Printed in China
OSTH0901-01 8