

Panasonic®

INSTALLATION AND OPERATING INSTRUCTIONS

Ventilating Fan

Model No. **FV-24JR2** **FV-24JA2**

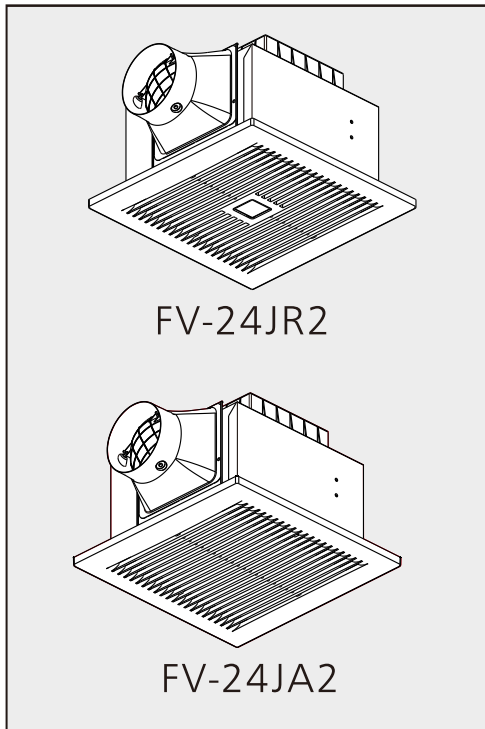

CONTENTS

SAFETY INSTRUCTIONS	2
INSTALLATION CAUTIONS	2-4
PART NAME AND DIMENSIONS	5
SUPPLIED ACCESSORIES	6
HOW TO INSTALL	6-12
SWITCH INDICATION	13
OPERATION	13
OPERATION AND ROUTINE MAINTENANCE	14-15
TROUBLE SHOOTING GUIDE	Back cover
WIRING DIAGRAM	Back cover
SPECIFICATIONS	Back cover

Thank you very much for purchasing this Panasonic Ventilating Fan.
Please read these instructions carefully before attempting to install, operate or service the Panasonic Ventilating Fan.
Failure to comply with instructions could result in personal injury or property damage. Please explain to users how to operate and maintain the product after installation, and this booklet should be presented to users. Please retain this booklet for future reference.

SAFETY INSTRUCTIONS Please observes strictly





The following instructions should be strictly observed in order to prevent injury to the users and other people, or damage to property.

- The degrees of injury or damage that can be occurred when the instructions are ignored and if the product is not used properly have been classified and described by the following indications.

	WARNING Those things shown in this column indicate that there is possibility of causing death or severe injury.
---	--







	CAUTION Those things shown in this column indicate that there is possibility of causing injury to the users or damage.
---	---

- Types of instructions that should be observed have been classified and described by the following pictorial symbols.

 	This symbol indicates the item is "PROHIBITED" to do.
 	This symbol indicates the "COMPULSORY" item that must be followed without failure.
	This symbol indicates the item is "CAUTION" .

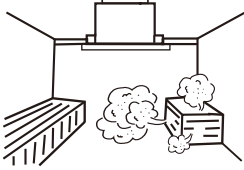
INSTALLATION CAUTIONS

WARNING

- | | |
|---|--|
| <ul style="list-style-type: none"> ■ A grounding device is required.  Product failure or electric leakage may cause electric shock. ■ Do not install the product as the method which is not approved in the instruction.  Improper installation may cause the product to fall off. ■ Do not install it at places where steam is present.   Short circuit may result in fire. | <ul style="list-style-type: none"> ■ Use this product at the rated voltage and frequency indicated on the name plate.  This may damage the product or result in fire. ■ Do not install the power switch in the bathroom.  Short circuit may result in fire. ■ Do not install the ventilating fan outside of the window or the wall.  Improper installation may cause the product to fall off. |
|---|--|

INSTALLATION CAUTIONS (CONTINUED)

WARNING

- Install this product securely.

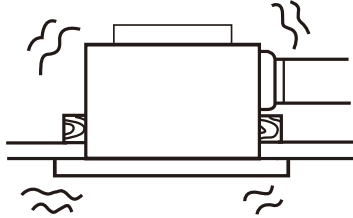

Improper installation may cause the product to fall off.

- The lowest surface of this product should be mounted above 2.3m from the floor after installation.

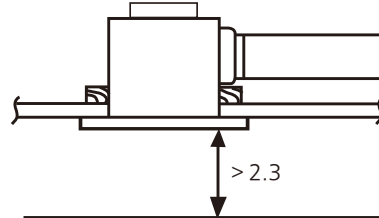

Touching the product may result in injury.

- The special-purpose or dedicated parts, such as mounting fixtures, must be used if such parts are provided.



Improper installation may cause the product to fall off.

- Precautions must be taken to avoid the back-flow of gases into the room from the open-flue of gas or other fuel-burning appliances.



This may result in fire.

- This fan must be installed by qualified technician.



Improper installation may cause the product to fall off.

- Use a device for disconnection from the supply, which having a contact separation of at least 3mm in all poles (switch), which must be incorporated in the fixed wiring in accordance with the local electrical wiring rules.



Short circuit may result in fire.

- Suggest using 60227 IEC 53(RW) ordinary polyvinyl chloride sheathed cord. Nominal cross-sectional area of conductors is $3 \times 0.75\text{mm}^2$ (suited for FV-24JR2) or $4 \times 0.75\text{mm}^2$ (suited for FV-24JA2).



It may cause damage to the product or a fire may be caused.

INSTALLATION CAUTIONS (CONTINUED)

⚠ CAUTION

- Do not install this product in places with excessive oil mist.

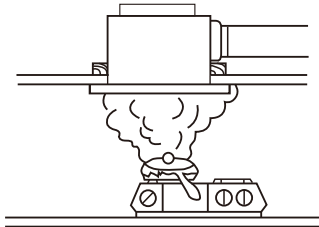

Short circuit may result in fire.

- Do not install this product on an inclined ceiling.

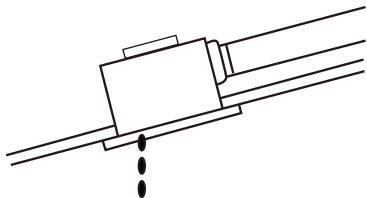

Rainwater may flow back into the room.

- Make sure there is a square inspection hole of at least 45 cm.

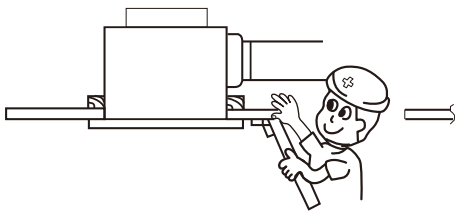

This may make installation and maintenance difficult.

- Make sure that the parts are installed securely.

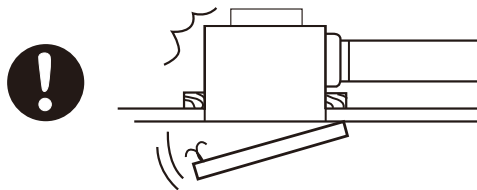

Parts may fall off.

- Do not install this product in places near high temperature.

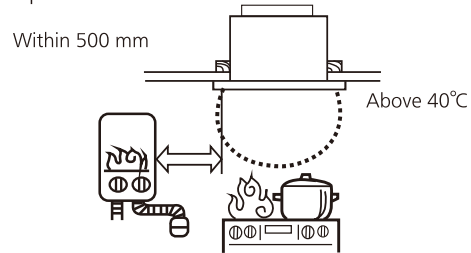

This may shorten the product service life.

- To install the duct, avoid the following cases.

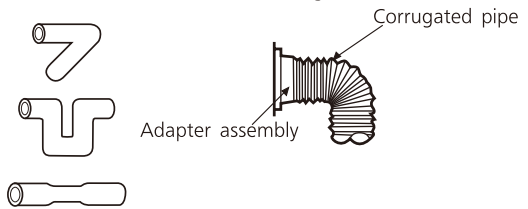

This may affect product performance.

- Be sure to provide an appropriate opening for air intake.

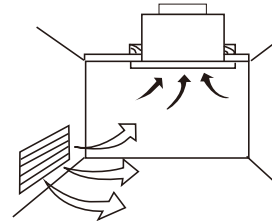

This may affect the ventilation performance of the product.

- Installation regulation concerning local requirement should be fulfilled.



This may damage the product's structure and decrease its safety.

PART NAME AND DIMENSIONS

Unit: mm

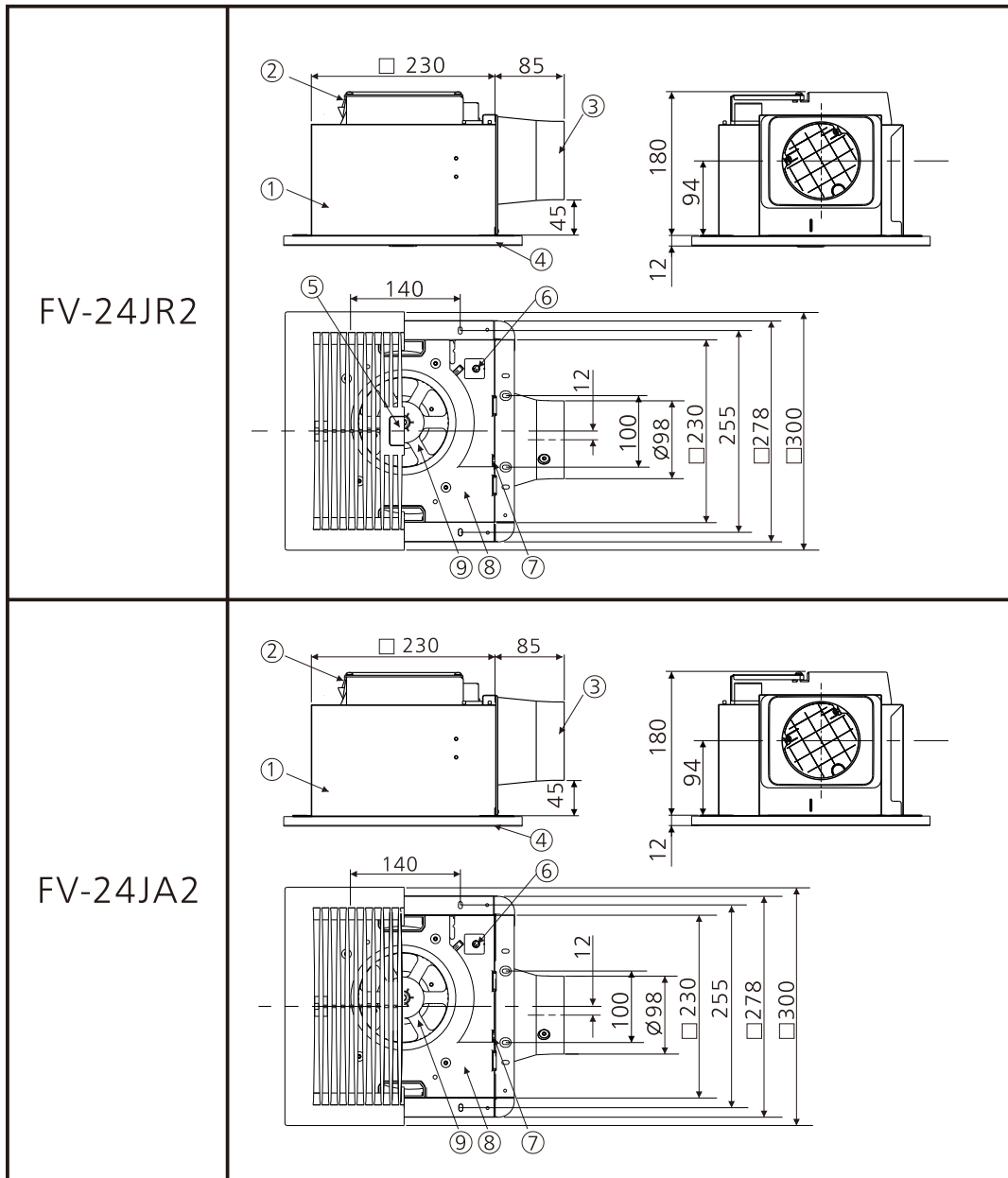

Duct Size
Ø 100

No.	Part name	No.	Part name	No.	Part name
①	Fan body	②	Wiring box	③	Adapter assembly
④	Louver	⑤	Sensor unit (For FV-24JR2 Model)	⑥	Air volume switch
⑦	Hexagon screw	⑧	Orifice	⑨	Blade

SUPPLIED ACCESSORIES

The following accessories are provided with the ventilating fan in the package. When you unpack, check if the accessories are all included. If any accessory is missing, please contact the dealer.

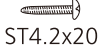
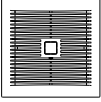
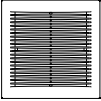
Appearance	Name and Purpose	Quantity
	Installation and Operating Instructions	1
 ST4.2x20	Tapping screw (ST4.2x20) fixing the body assembly and the adapter assembly to the wooden frame	6
	Louver (FV-24JR2 model's louver is connected with fan body)	1
	Louver (For FV-24JA2 Model)	1

HOW TO INSTALL

■ Installation illustrations are based on the FV-24JR2 model. Please wear gloves during the installation.

WARNING

■ When you unpack and take out the product, be sure to take out the louver and the fan body together, because the sensor lead wire is connected between the louver and the fan body.

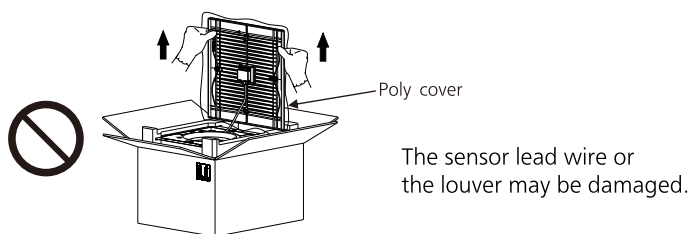
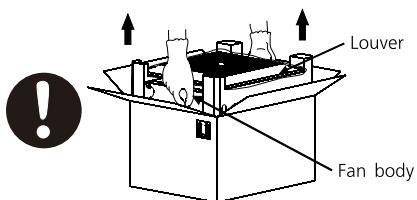

HOW TO INSTALL (CONTINUED)

CAUTION

- Be sure not to add any tension on the sensor lead wire between the louver and the fan body when installing this fan.



The sensor lead wire or the louver may be damaged.

- When you install the fan, be careful not to be struck by the hanging louver.



This may cause injury or damage the louver.

- Do not take out the louver from the poly cover before install it.



The dirt may adhere to the louver or damage may be caused.

1 Preparations

- Peel off the caution label and screws accessory stucked on the adapter assembly.

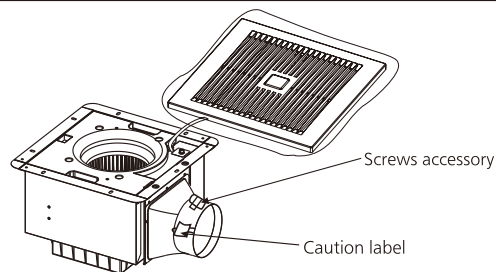

→ 2

2 Power Cord Connection

- ① Loosen the terminal box cover screws (2 pcs) and cord clip screws (2 pcs), connect the power cord to the wiring terminal block according to wiring methods below. (The detailed wiring methods please refer to wiring diagram page 8.)

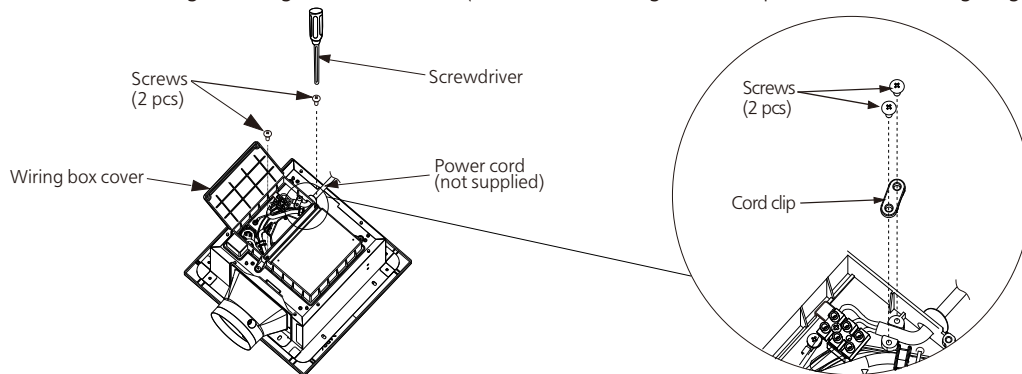

HOW TO INSTALL (CONTINUED)

- Put the power cord into the terminal box before wiring.

FV-24JR2

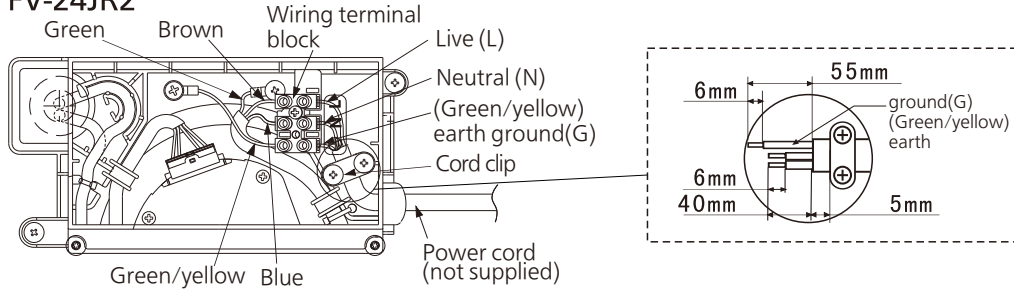

FV-24JA2

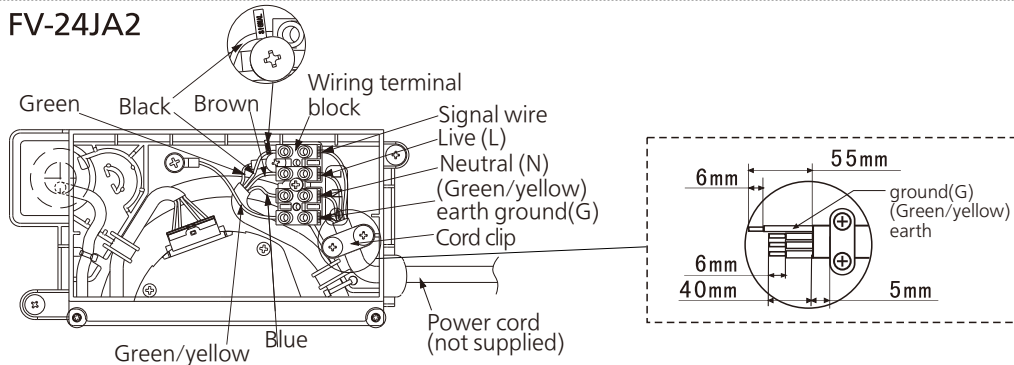

- For the stripping length, please according to the wiring sketch (refer to above figure). If the stripping length is too long, it may cause short circuit.
 - Do not damage the sheath of the power cord.
 - Strand the core wire together into a bundle, then insert them into the deep position of the terminal block, ensuring that the screw terminal column of wiring terminal block is pressed on copper and no copper core cord is exposed outside. Otherwise a short circuit or an electric shock may be caused.
 - Tighten the wiring screw, and confirm all the wires are fixed reliably.
- ② After wiring, fix the power cord with cord clip reliably, then put the wiring box cover back on and fix by screws reliably (2 pcs).

⚠ WARNING

- Be sure the screws of wiring box cover are tightened firmly.



This may cause electric shock.

→ 3

HOW TO INSTALL (CONTINUED)

3-A Fan Body Installation (with wooden joist)

① Build a wooden frame horizontally from the wooden joist. Note that the distance between the top of the fan body and the ceiling should be at least 20 mm.

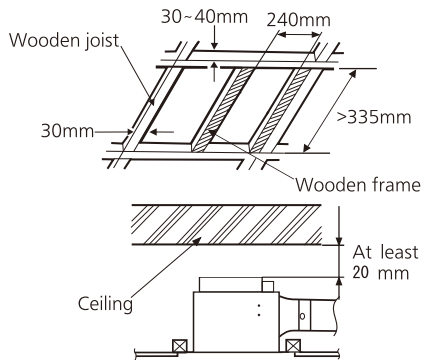

② Keep the power cord above the fan body, then insert the fan body to the wooden frame as shown in the figure and firmly secure the fan body with six tapping screws (ST4.2x20).

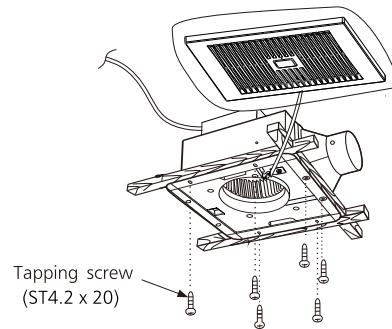

■ Wooden joist and wooden frame must be subjected to static load more than five times the weight of the product.



3-B Fan Body Installation (with anchor bolts)

① Secure the suspension bracket FV-KB021C (not supplied) with screws.

■ Be sure to use the screws in the FV-KB021C package.

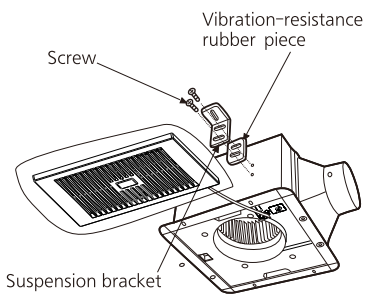

■ Suspension bracket position

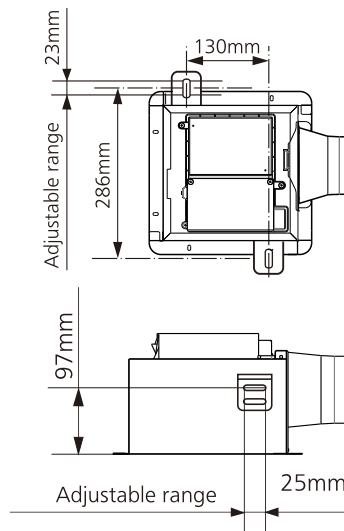

② Mount the fan body enclosure on the anchor bolts (M8-M10, not supplied).

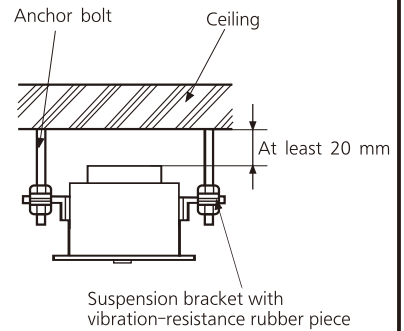

■ Note that the distance between the top of the fan body and the ceiling should be at least 20 mm.



HOW TO INSTALL (CONTINUED)

3-C Fan Body Installation (Install the adapter assembly first)

- ① First remove the hexagon screw attaching the adapter assembly to the fan body.

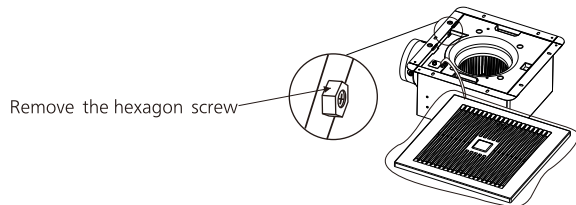

- ② Remove the adapter assembly by following steps 1 and 2 as shown in the figure.

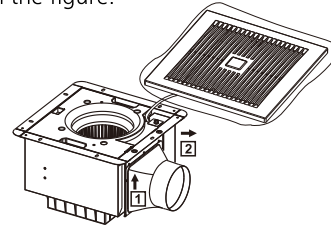

- ③ Build a wooden frame horizontally from the wooden joist. Note that the distance between the top of the fan body and the ceiling should be at least 20 mm.

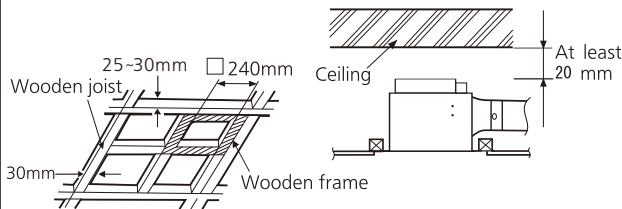

- Wooden joist and wooden frame must be subjected to static load more than five times the weight of the product.

- ⑤ Keep the power cord above the fan body, then insert the fan body in the wooden frame, and connect it to the adapter assembly.

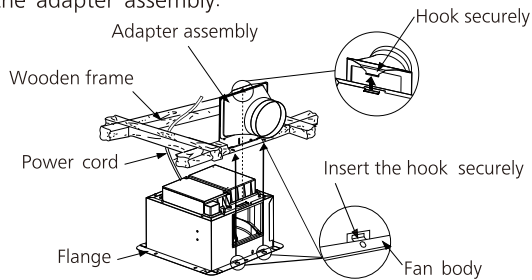

- Ensure that the power cord completely passes through the wooden frame, lest the fan body and wooden frame would clamp to damage the power cord.

- ⑥ Secure the fan body with four tapping screws (ST4.2x20).

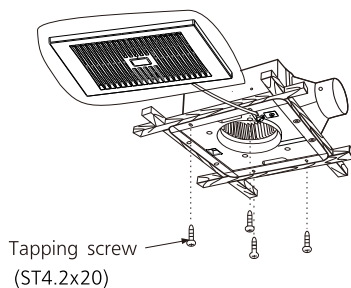

- ④ Install the adapter assembly by clinging to the wooden frame as shown in the figure, and fix the adapter assembly to the wooden frame with two tapping screws (ST4.2x20).

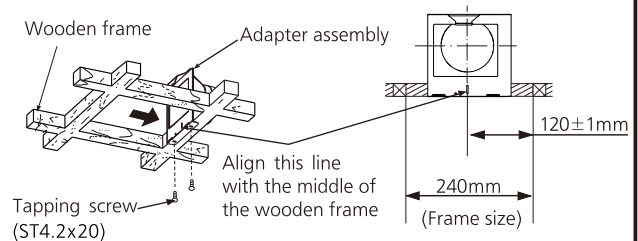

- If the adapter line does not align with the middle of the wooden frame, you may not be able to install the fan body onto the adapter assembly.

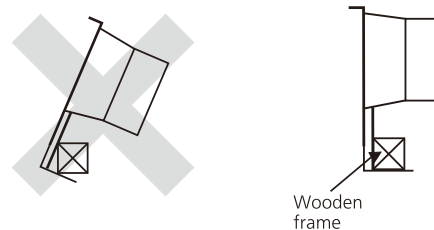

- ⑦ Tighten the hexagon screws fixing the fan body to the adapter assembly with a screwdriver.

- Upon installation, check that the fan body and adapter assembly are installed securely.

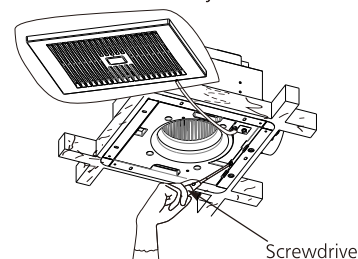

4

HOW TO INSTALL (CONTINUED)

4 Duct Connection and Joist Plate Installation

- ① Insert the duct into the adapter assembly, and tighten it with adhesive tape (not supplied). (Suspend the duct from the ceiling to prevent any external force onto the fan body.)

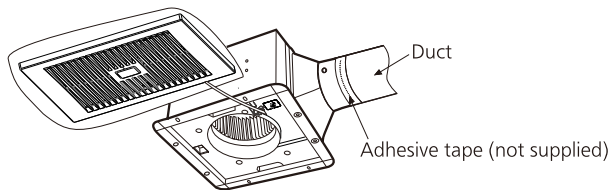

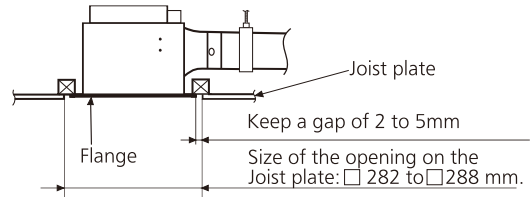

- ② Install the joist plate. Note that the gap between the flange and the joist plate should be 2 to 5 mm.

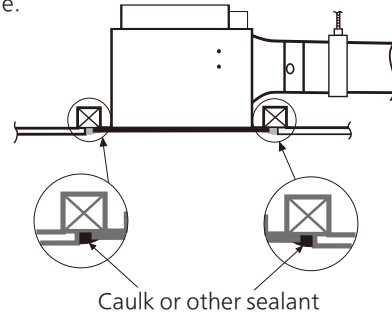

- After finishing the ceiling job, fill gap between flange and joist plate with caulk or other sealant to prevent air leakage.



- ③ Install the pipe hood or vent cap (not supplied) on the outer wall.

Pipe hood	Vent cap
FV-MCX100P	FV-VCX100P
	

- Slope the duct downward and guide it through the wall to the outside. Be sure to prevent rainwater from falling in the duct from its outlet. (The minimum size of the opening on the wall is: $\varnothing 116\text{mm}$)

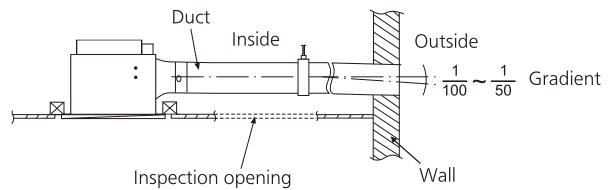

→ 5

5 Louver Installation

- ① Take off the poly cover before installing the louver and please wear gloves during the louver installation.
- ② First, insert the mounting spring 1 into the slot near the switch knob as shown in the figure.
- ③ Adjust the air volume switch by following the switch indication on page 13.

HOW TO INSTALL (CONTINUED)

- ④ For FV-24JR2 model: Check that the sensor lead wire is in the wire hook and does not fall off. Be sure to tidy up the sensor lead wire and keep it away from the air intake and fan blades.

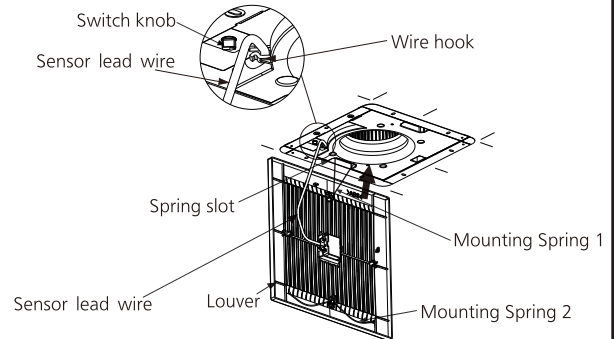

- ⑤ Finally, insert the mounting spring 2 into another slot and mount louver to the fan body.

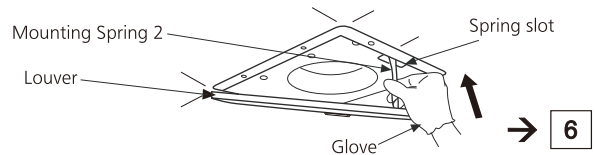

6 Test run

- ① When the power is turned on, check for functions as follows:

■ Fan function :

- Do the fan blades rotate anti-clockwise?
- Is there any abnormal sound or vibration?

■ Sensor function (For FV-24JR2 model):

Toggle the air volume switch to the "0" position by following the switch indication on page 13. Does the LED indicator blink when the sensor detects motion of a person? Do the fan blades rotate properly? Do the fan blades stop rotating automatically in 15 minutes after the person leaves? After function check completes, toggle the air volume switch to the factory default position by following the switch indication on page 13.

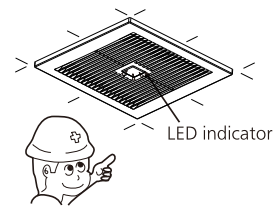

■ Functions of the wall signal switch (For FV-24JA2 model):

Toggle the air volume switch to the "0" position by following the switch indication on page 13. Do the fan blades rotate properly after the wall signal switch (not supplied) is turned on? Do the fan blades stop rotating automatically in 15 minutes after the wall signal switch is turned off? After function check completes, toggle the air volume switch to the factory default position by following the switch indication on page 13.

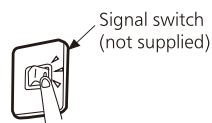

- ② In case of any exceptions, check whether all the parts are installed correctly.

SWITCH INDICATION

Air volume switch positions

Air Volume (m ³ /h)	▼	0	80	120	160
--------------------------------	---	---	----	-----	-----

Initial setting: 80 m³/h

The "▼" position is used for factory test only. Do not use this position.



Air volume switch

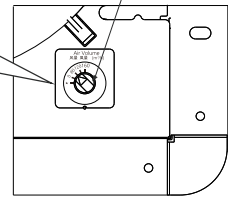

OPERATION

① Motion sensor (For FV-24JR2 model)

Detectible range

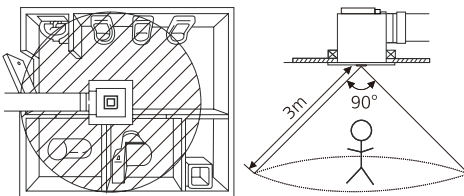

At the condition that the room temperature is 25°C:

- The distance that can be detected is about 3m.
- The field of view of the sensor is about 90°.

■ When the sensor detects motion of a person, the fan keeps running at the maximum air volume until the delay time ends.

■ When new motion is detected by sensor in the delay time stage, the delay time will be counted again.

② The air volume is controlled by the air volume switch.

● Sensor function

FV-24JR2	Human action	Inside	Enter	Leave	Outside
	Fan action	The fan runs		When the sensor detects motion of a person, the fan runs at the maximum air volume. The fan keeps running at the maximum air volume until the delay time ends, and then the initial position is restored.	
	Air volume status	160 120 80 0 (m ³ /h)		15 minutes in delay	

● Functions of the wall signal switch

FV-24JA2	Human action	Inside	Enter	Leave	Outside
	Fan action	The fan runs		When the wall signal switch is turned on, the fan runs at the maximum air volume. When the wall signal switch is turned off, the fan keeps running at the maximum air volume until the delay time ends. Then the initial position is restored.	
	Air volume status	160 120 80 0 (m ³ /h)		15 minutes in delay	

OPERATION AND ROUTINE MAINTENANCE

WARNING

- A grounding device is required.



Product failure or electric leakage may cause electric shock.

- Do not disassemble the product for repair or alteration.



This may cause fire or electric shock. Contact the designated repair store and ask qualified professionals to maintain or repair your product.

- Do not spray water or any other liquids directly onto this product or clean it with any liquids.



This may cause short circuit or electric shock.

- Before touching this product, ensure that the power switch connected to this product is turned off.



This may result in electric shock.

- Be sure to uninstall the product if it will not be used any longer.



The product may fall off.

- This product is applicable to living rooms, washrooms and other places where the humidity is not too high.



This may cause short circuit or electric shock.

- This appliance is not intended for use by persons (including children) with reduced physical, sensory or mental capabilities, or lack of experience and knowledge, unless they have been given supervision or instruction concerning use of the appliance by a person responsible for their safety. Children should be supervised to ensure that they do not play with the appliance.



This may result in personal injury.

- Use this product at the rated voltage and frequency indicated on the name plate.



This may damage the product or result in fire.

- In case of gas leakage, do not turn on/off this product.



This may generate electric spark and lead to an explosion.

- Keep water away from the motor.



This may damage the product or result in fire.

- When you clean the louver, do not put your hand in the louver gap.



This may result in injury.

- If the supply cord is damaged, it must be replaced by the manufacturer or its service agent or a similarly qualified person in order to avoid a hazard.



This may damage the product or result in fire.

Requirement

- Routine maintenance is required every year. Disconnect the power source before you conduct any maintenance.
- Do not immerse blade or other resin parts in hot water over 60°C.
- Do not use petrol, benzene, thinner or any other such chemicals for cleaning the ventilating fan.

OPERATION AND ROUTINE MAINTENANCE (CONTINUED)

Routine Maintenance

For FV-24JR2 model:

- ① Pull down the mounting spring to the right of the "Panasonic" logo as described in steps 1 and 2 in the figure.

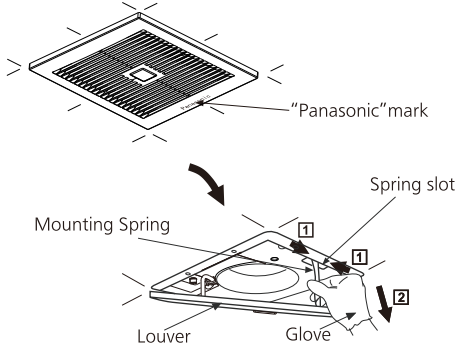

- ③ Clean the dirt from the fan body using a suction cleaner.

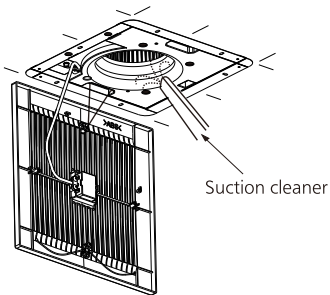

- ② Clean the louver and the sensor cover with a soft dry cloth. Be sure not to add any tension on the sensor lead wire.

■ Do not use any liquid or water to clean the louver.

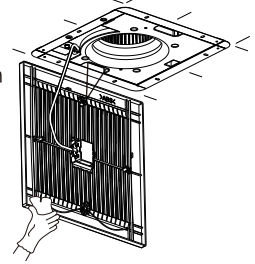

■ Do not disassemble the sensor unit from the louver when cleaning.

- ④ Wipe the dust off the fan body with a soft cloth moistened with kitchen detergent. Then clear it with a clean soft cloth. Finally, replace the louver. Install the louver by referring to "Louver Installation" on page 11 to 12.

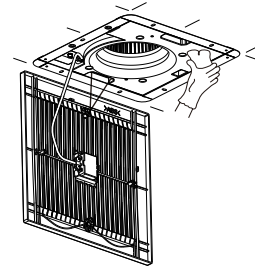

For FV-24JA2 model:

- ① Pull down the mounting spring as described in steps 1 and 2 in the figure, and then remove the louver.

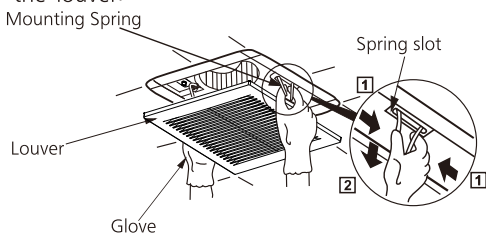

- ③ Clean the dirt from the fan body using a suction cleaner.

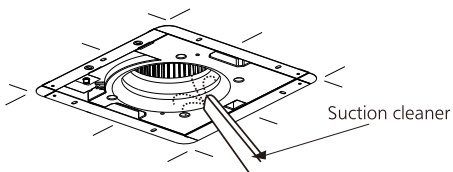

- ② Rinse the louver with water, and then dry it with a soft dry cloth or leave it air dry.

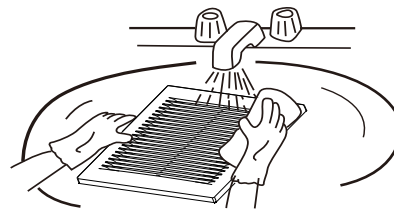

- ④ Wipe the dust off the fan body with a soft cloth moistened with kitchen detergent. Then clear it with a clean soft cloth. Finally, replace the louver.

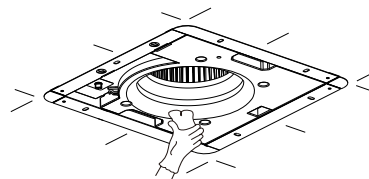

TROUBLE SHOOTING GUIDE

Check according to the following table and correct the problem. If the fan still does not work correctly, disconnect the power source and contact the dealer.

PROBLEM	CAUSE	ACTION
The fan does not run at the maximum air volume when a person is within the sensing range of the sensor.	Is the room temperature near the temperature of human body?	Check again after the room temperature drops
	Is the sense of the sensor slow to the people's motion?	Make sure there is no obstacle near the product.
	Is the sensor unit dirty?	Clean the dirt according with "OPERATION AND ROUTINE MAINTENANCE" at page 14 to 15.

WIRING DIAGRAM

FV-24JR2

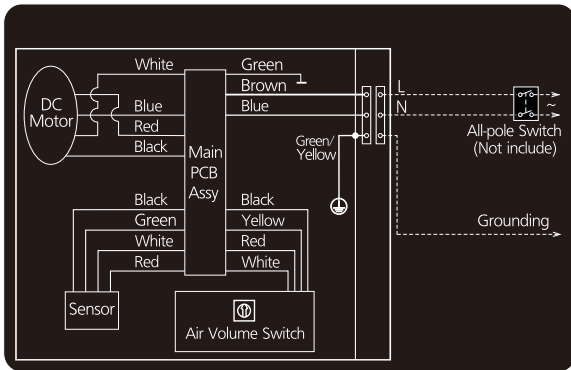

FV-24JA2

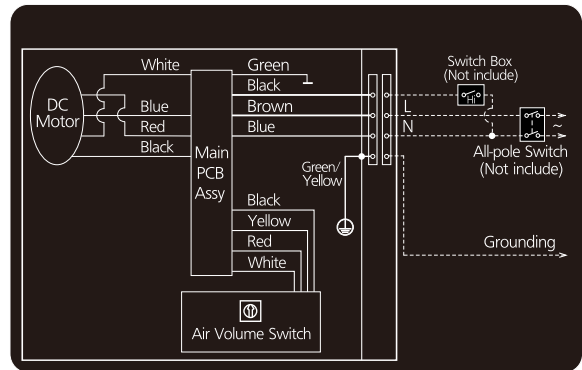

SPECIFICATIONS

Model	Voltage [V]	Frequency [Hz]	Power consumption [W]	Air Volume [m ³ /h]	Noise [dB(A)]	Static pressure [Pa]	Net weight [kg]
FV-24JR2/ FV-24JA2	240	50	8.0	160	31	170	2.9
			5.2	120	26	170	
			3.6	80	20	170	

1. The values of rated input, air volume and noise are specified at the static pressure of 0 Pa.
2. The values of noise level is A weighted average sound pressure level, the mean value are measured by our company, within +3 and -7 tolerance.
3. Test method: In the noise test room, measure the noise value at a position 1 m away from the left side/right side/bottom of the sample respectively, and then calculate the average value.
4. The values of air volume are the mid-points of results measured by our company, with $\pm 10\%$ tolerance.
5. Static pressure is the central value of the company's test results when the air volume is 0, with a lower deviation of -10%.

* The above parameters are subject to change without a prior notice.

Insulation Class E

IP Code: IPX2

Type of insulation: Functional Insulation

Panasonic Corporation

Web Site: <http://www.panasonic.com>

© Panasonic Corporation 2015

P0915-0 24JR20423