

# Dimensions

## 1 Indoor Unit

### 1.1 CS-XZ9ZKH-8 / CS-XZ12ZKH-8

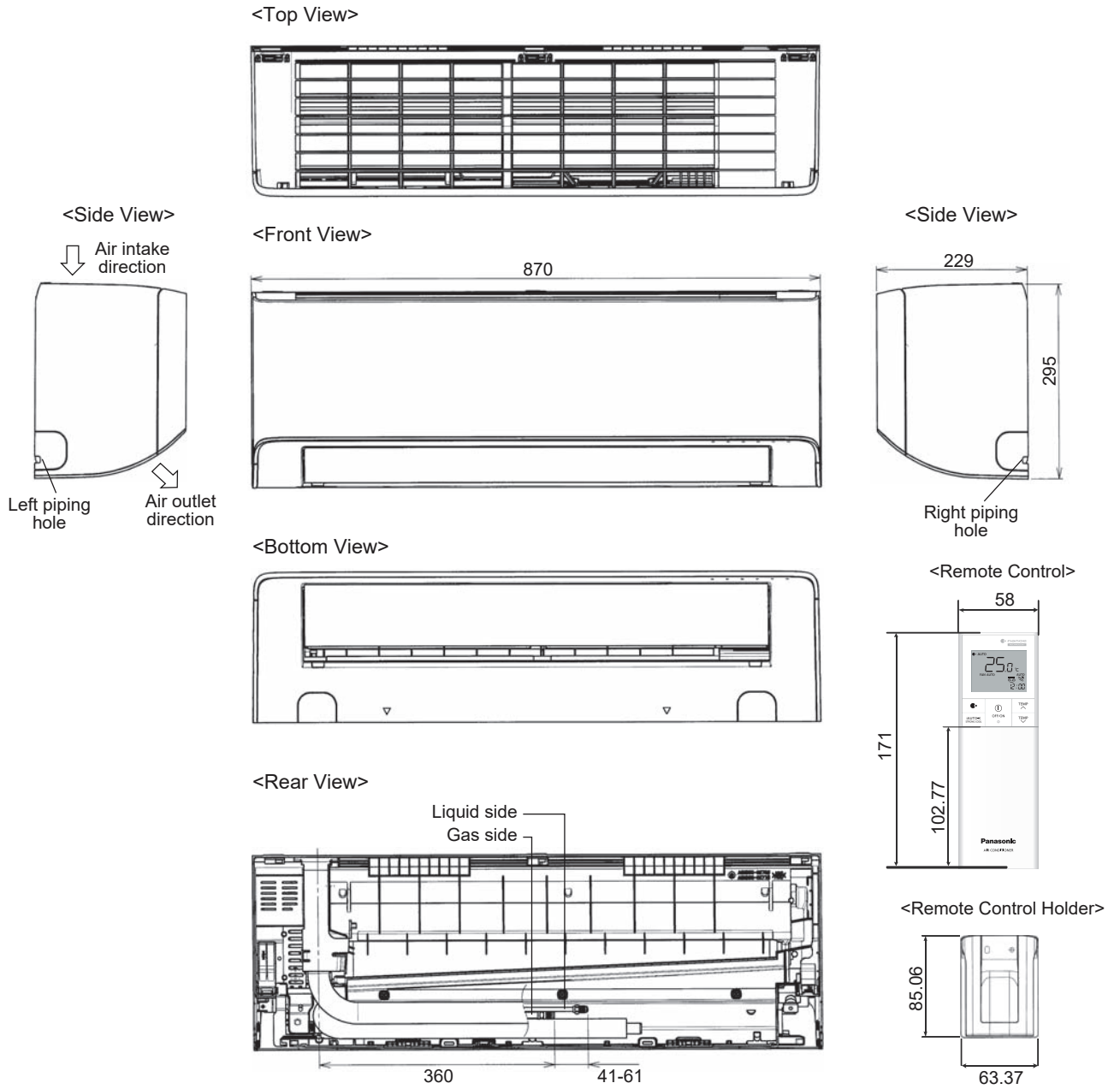

Relative position between the indoor unit and the installation plate <Front View>

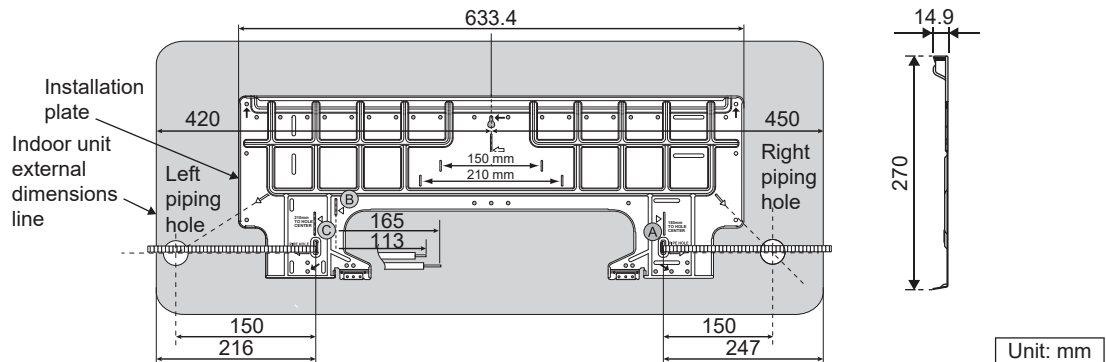

# 1.2 CS-XZ18ZKH-8 / CS-XZ24ZKH-8

<Top View>

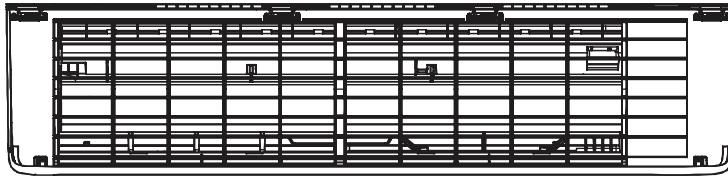

<Side View>

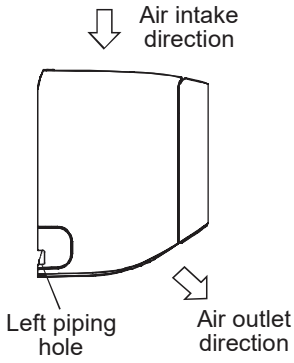

<Front View>

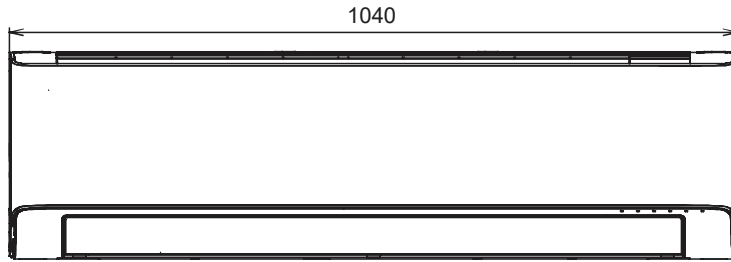

<Side View>

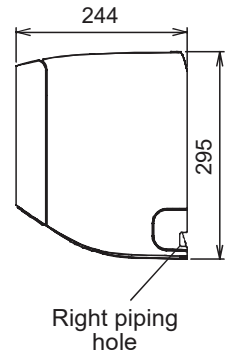

<Bottom View>

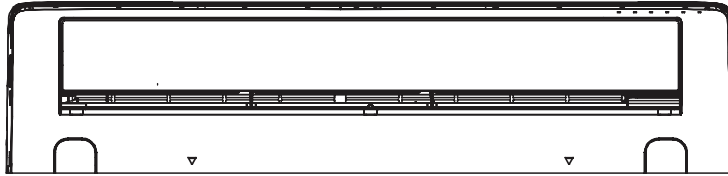

<Remote Control>

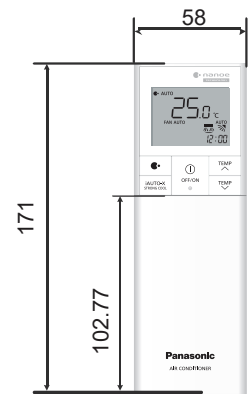

<Rear View>

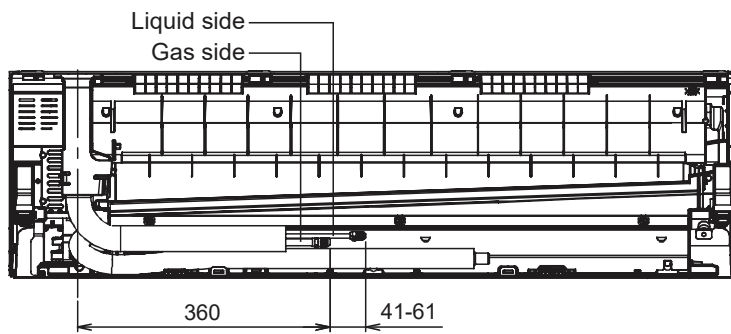

<Remote Control Holder>

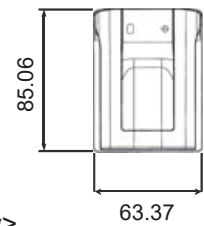

Relative position between the indoor unit and the installation plate <Front View>

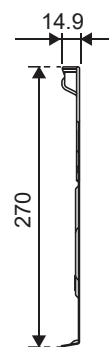
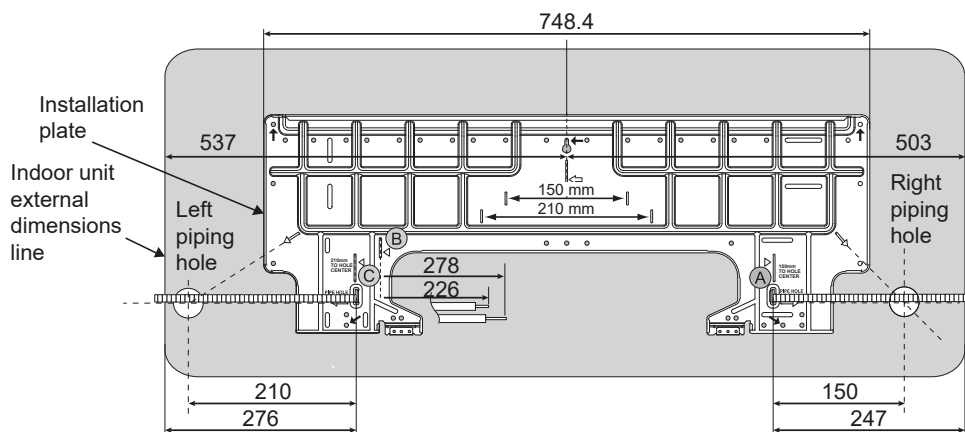

Unit: mm

## 2 Outdoor Unit

### 2.1 CU-XZ9ZKH-8 / CU-XZ12ZKH-8

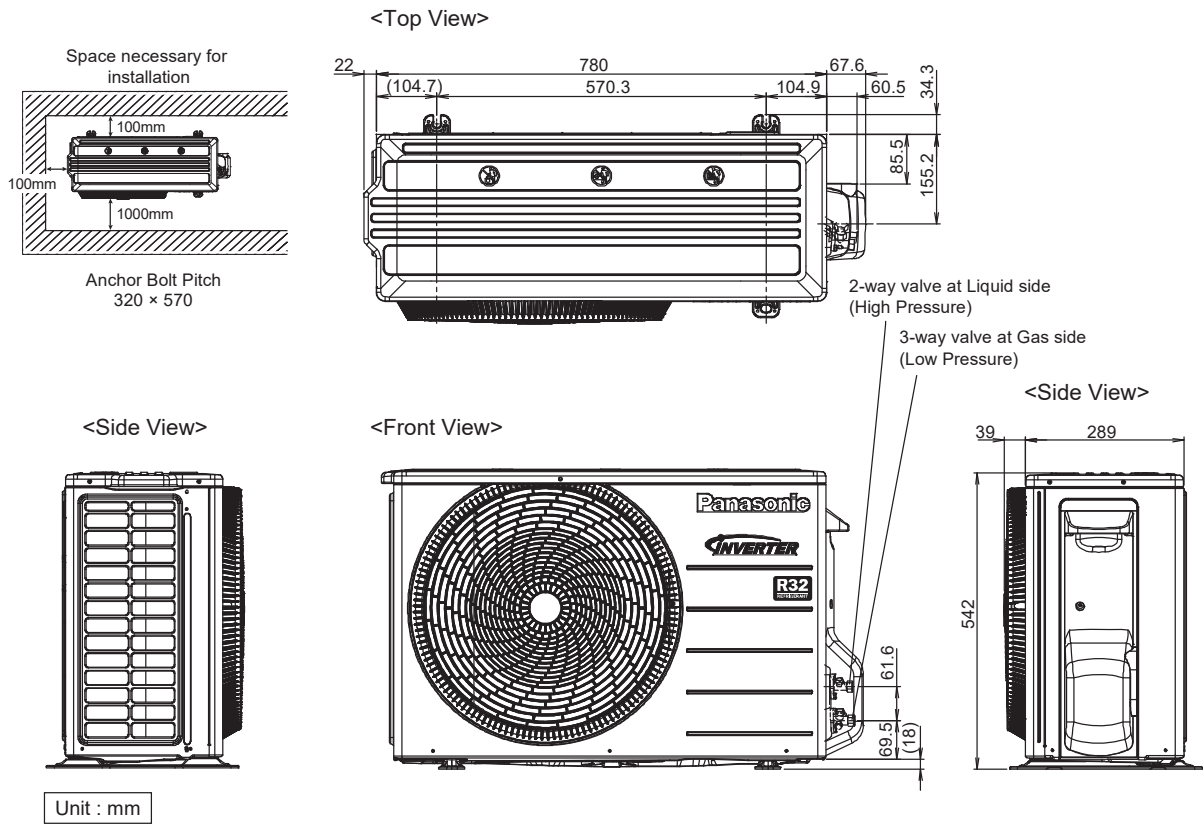

### 2.2 CU-XZ18ZKH-8 / CU-XZ24ZKH-8

