

External Dimensions

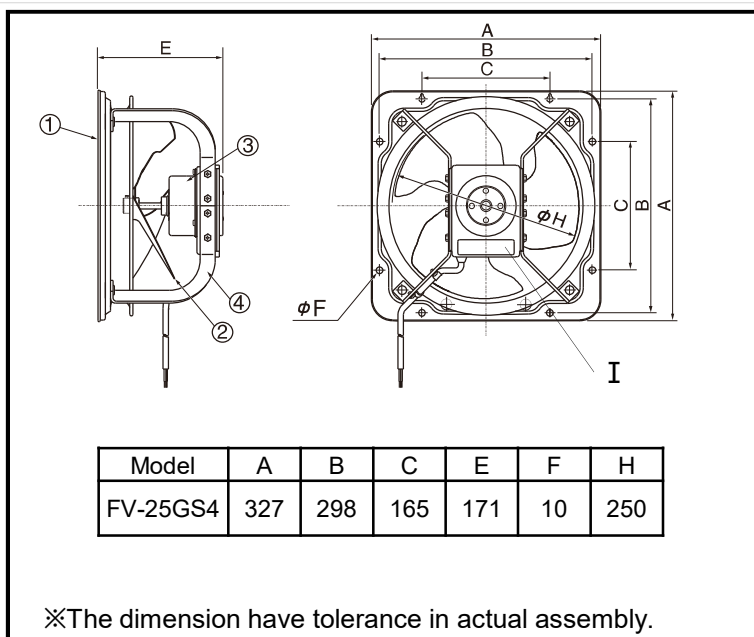

Unit: mm

Labeling Position

Mark	Item	Comment
I	NAME PLATE	-

Component Parts List

Main Parts List

Mark	Part Name	Material	Quantity
①	Frame	Metal	1
②	Blade	Metal	1
③	Motor	Metal	-
④	Motor Support	Metal	4

Accessory List

Item	Quantity	comment
Operating instruction	1	-
Assembling instruction	1	For separated package
Warranty card	1	For Vietnam market

Authentication Information

认证种类 (测试机构等) IEC (TUV)

Product		Page		1/5	
Ventilating Fan		Model			
		FV-25GS4			
Make Date	2022.03.09	Scale	Drawing No.	HPVF22001	
Modification Date			Modification No.		
Panasonic Ecology Systems Guangdong Co., Ltd.					

■ Specification Data (FV-25GS4 220~240V 50Hz)

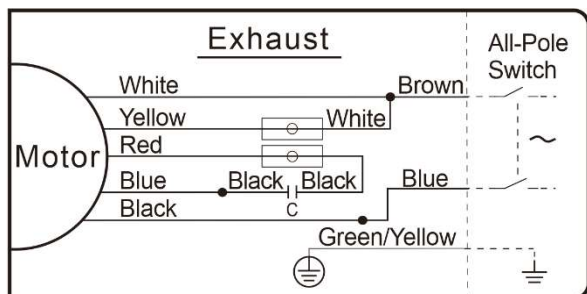
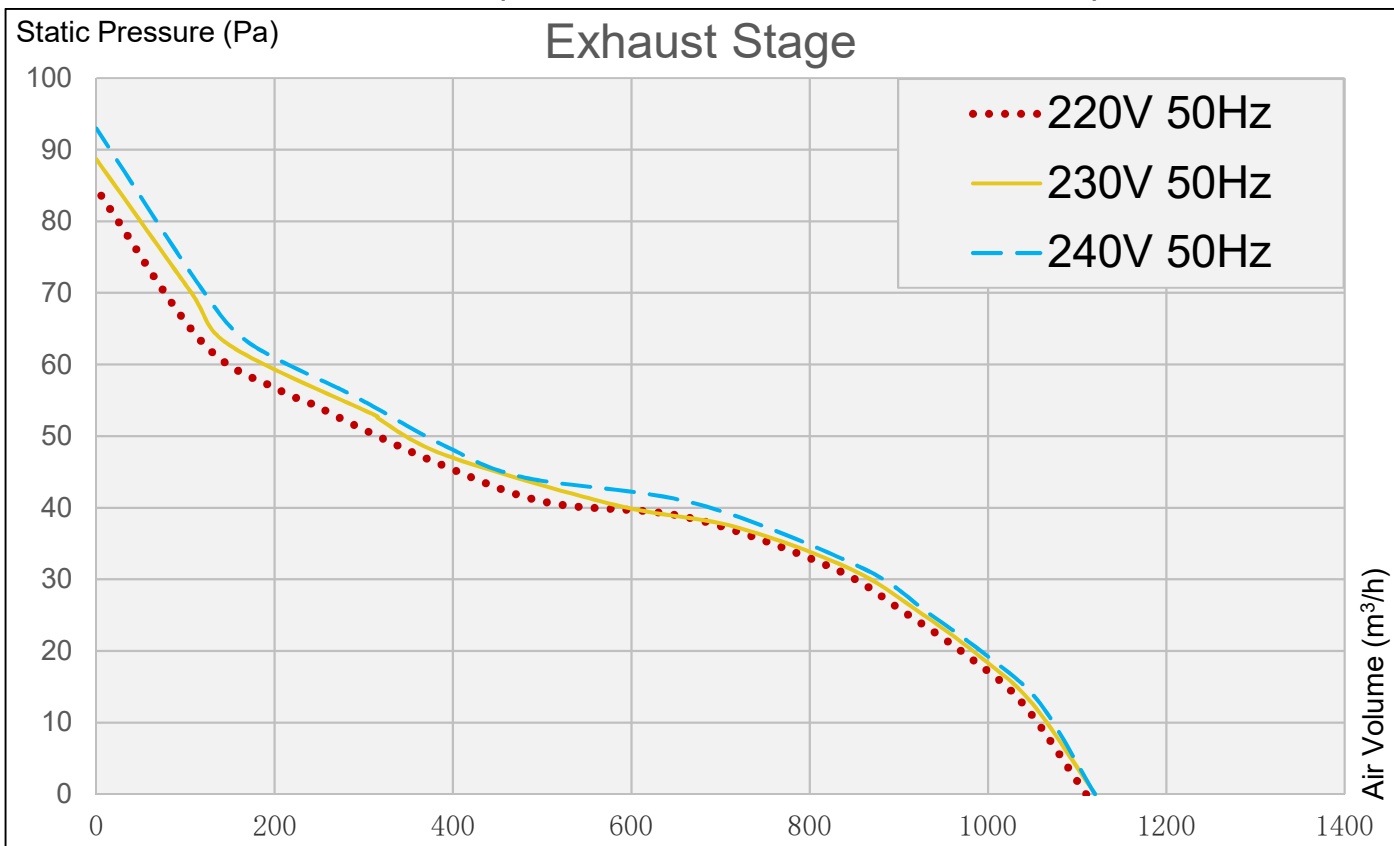

MODEL	FV-25GS4		
	Exhaust Stage		
Rated Voltage (V)	220	230	240
Rated Frequency (Hz)	50	50	50
Power Consumption (W)	39	42	44
Air Volume (m³/h)	1100	1120	1120
Noise (dB)	34.2	34.2	34.3
Net Weight (kg)	4.4		
Motor Type	AC Motor (Class E)		
Operating Temperature	-10°C~50°C		
Insulation Resistance	>10MΩ		
Electric Strength	AC1500V/1 minute		
Ventilation Hole Size	275mm*275mm		

■ Air volume, electric specification and noise value are measured when static pressure is 0 Pa.

■ Noise value is the weighted sound pressure grade A, which is the central value measured by this company, its tolerance range is from +3 to -7. The method to measure is as follows: in an anechoic chamber, measure noise value first 1m away from the left, right and center of the sample, then get the averaged value.

■ Air volume is the central value measured by this company with ±10% of tolerance range.

Product			Page	2/5
Ventilating Fan			Model	
			FV-25GS4	
Make Date	2022.03.09	Scale	Drawing No.	HPVF22001
Modification Date			Modification No.	
Panasonic Ecology Systems Guangdong Co., Ltd.				

■ Specification Data (FV-25GS4 220~230V 60Hz)

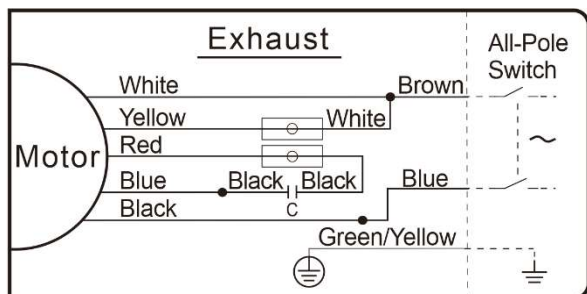
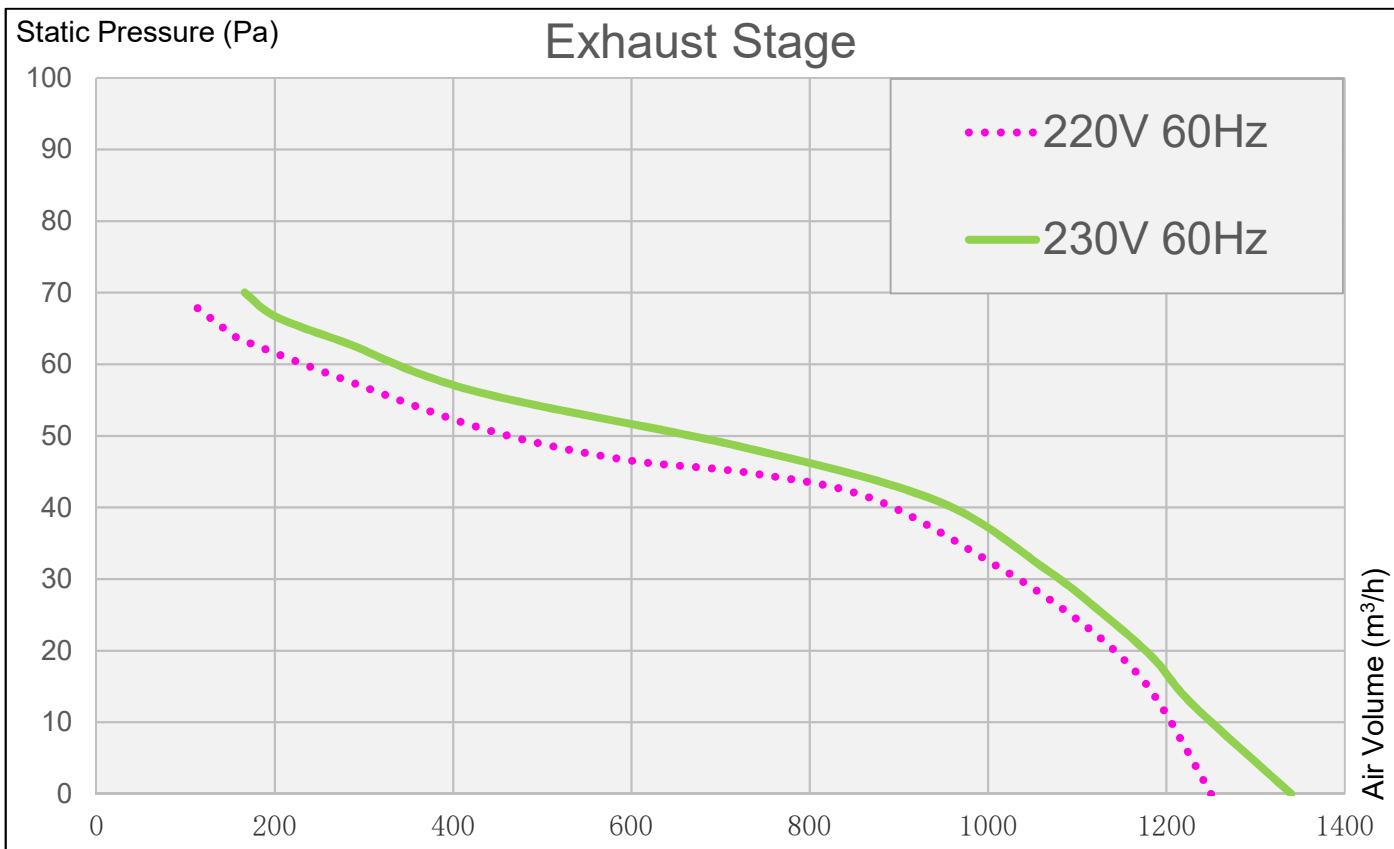

MODEL	FV-25GS4	
	Exhaust Stage	
Rated Voltage (V)	220	230
Rated Frequency (Hz)	60	60
Power Consumption (W)	47	50
Air Volume (m³/h)	1250	1340
Noise (dB)	38.7	38.9
Net Weight (kg)	4.4	
Motor Type	AC Motor (Class E)	
Operating Temperature	-10°C~50°C	
Insulation Resistance	>10MΩ	
Electric Strength	AC1500V/1 minute	
Ventilation Hole Size	275mm*275mm	

■ Air volume, electric specification and noise value are measured when static pressure is 0 Pa.

■ Noise value is the weighted sound pressure grade A, which is the central value measured by this company, its tolerance range is from +3 to -7. The method to measure is as follows: in an anechoic chamber, measure noise value first 1m away from the left, right and center of the sample, then get the averaged value.

■ Air volume is the central value measured by this company with ±10% of tolerance range.

Product			Page	3/5
Ventilating Fan			Model	
			FV-25GS4	
Make Date	2022.03.09	Scale	Drawing No.	HPVF22001
Modification Date			Modification No.	
Panasonic Ecology Systems Guangdong Co., Ltd.				

■ Specification Data (FV-25GS4 110~127V 50Hz)

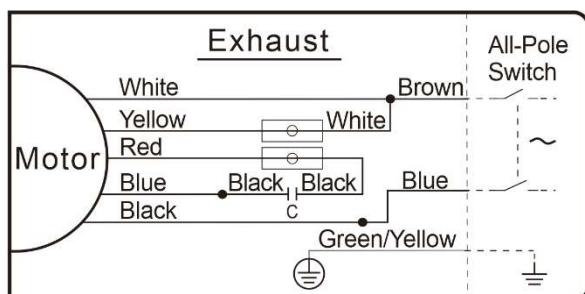
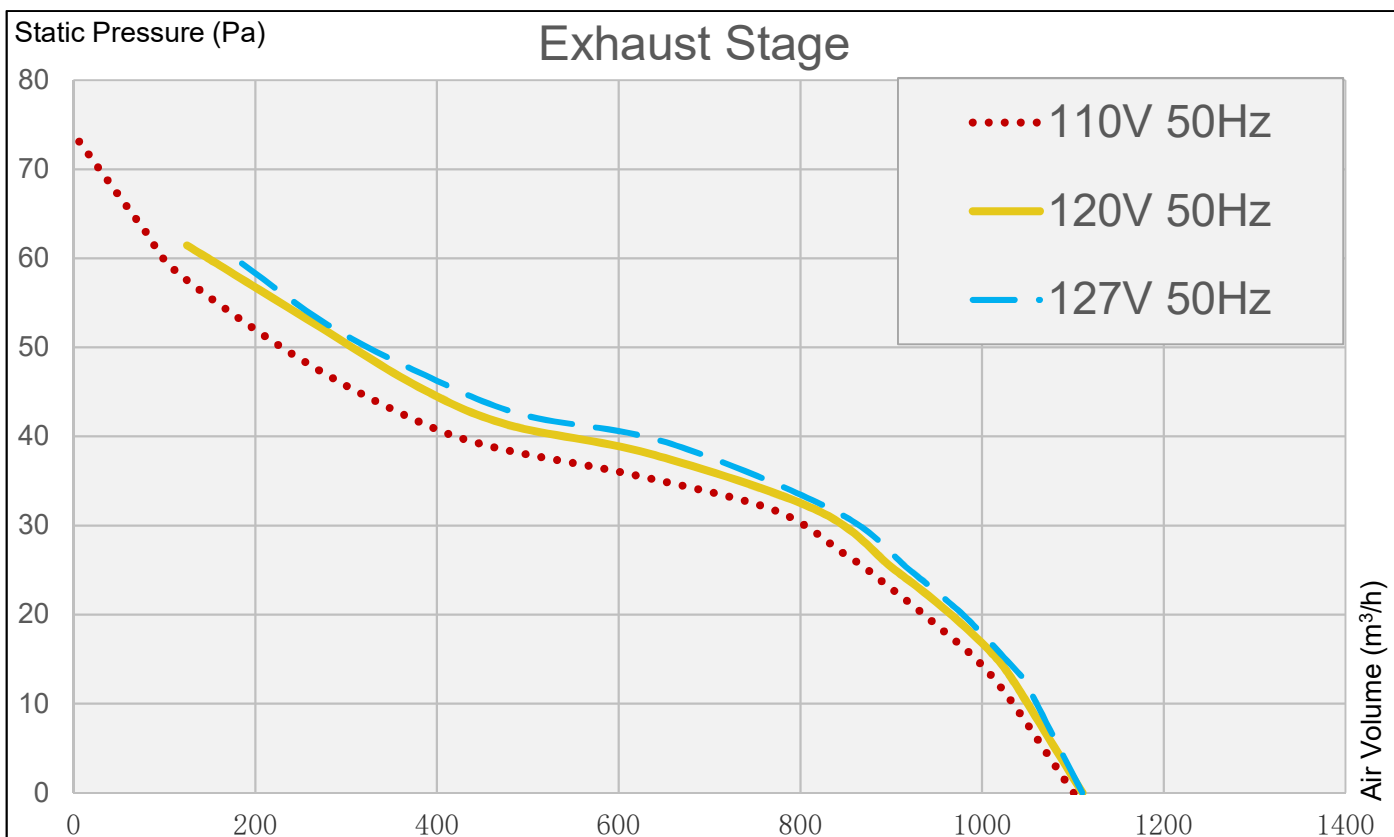

MODEL	FV-25GS4		
	Exhaust Stage		
Rated Voltage (V)	110	120	127
Rated Frequency (Hz)	50	50	50
Power Consumption (W)	38	42	46
Air Volume (m ³ /h)	1100	1110	1110
Noise (dB)	34	34.2	34.2
Net Weight (kg)	4.4		
Motor Type	AC Motor (Class E)		
Operating Temperature	-10°C~50°C		
Insulation Resistance	>10MΩ		
Electric Strength	AC1500V/1 minute		
Ventilation Hole Size	275mm*275mm		

■ Air volume, electric specification and noise value are measured when static pressure is 0 Pa.

■ Noise value is the weighted sound pressure grade A, which is the central value measured by this company, its tolerance range is from +3 to -7. The method to measure is as follows: in an anechoic chamber, measure noise value first 1m away from the left, right and center of the sample, then get the averaged value.

■ Air volume is the central value measured by this company with ±10% of tolerance range.

Product			Page	4/5
Ventilating Fan			Model	
			FV-25GS4	
Make Date	2022.03.09	Scale	Drawing No.	HPVF22001
Modification Date			Modification No.	
Panasonic Ecology Systems Guangdong Co., Ltd.				

■ Specification Data (FV-25GS4 110~127V 60Hz)

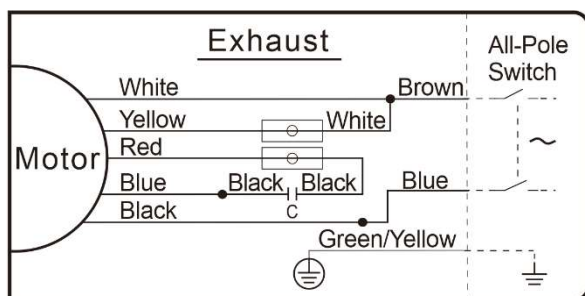
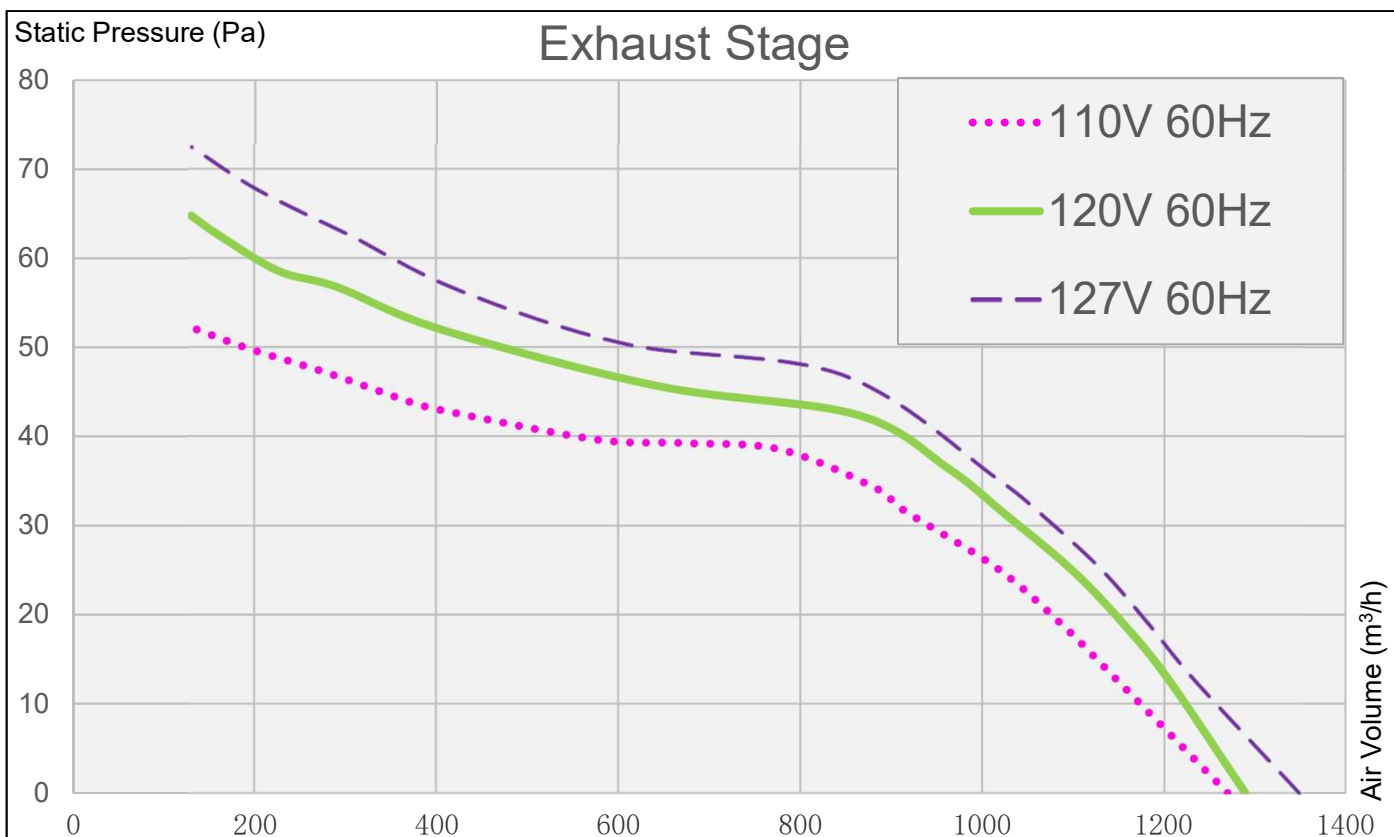

MODEL	FV-25GS4		
	Exhaust Stage		
Rated Voltage (V)	110	120	127
Rated Frequency (Hz)	60	60	60
Power Consumption (W)	45	48	51
Air Volume (m³/h)	1270	1290	1350
Noise (dB)	37.9	38.2	38.2
Net Weight (kg)	4.4		
Motor Type	AC Motor (Class E)		
Operating Temperature	-10°C~50°C		
Insulation Resistance	>10MΩ		
Electric Strength	AC1500V/1 minute		
Ventilation Hole Size	275mm*275mm		

■ Air volume, electric specification and noise value are measured when static pressure is 0 Pa.

■ Noise value is the weighted sound pressure grade A, which is the central value measured by this company, its tolerance range is from +3 to -7. The method to measure is as follows: in an anechoic chamber, measure noise value first 1m away from the left, right and center of the sample, then get the averaged value.

■ Air volume is the central value measured by this company with ±10% of tolerance range.

Product			Page	5/5
Ventilating Fan			Model	
			FV-25GS4	
Make Date	2022.03.09	Scale	Drawing No.	HPVF22001
Modification Date			Modification No.	
Panasonic Ecology Systems Guangdong Co., Ltd.				