

Dimensions

1 Indoor Unit

1.1 CS-N18ZKH-8 / CS-N24ZKH-8

<Top View>

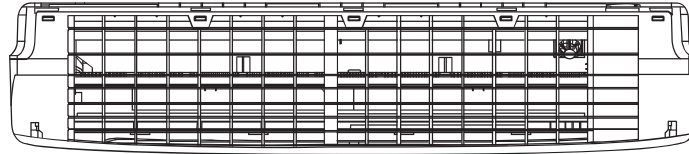

<Side View>

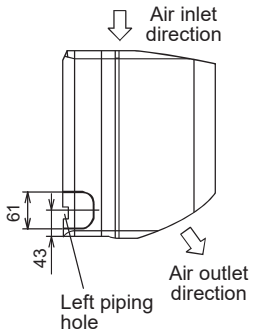

<Front View>

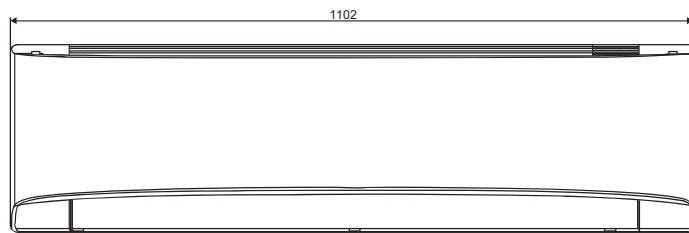

<Side View>

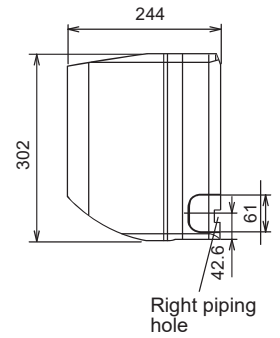

<Bottom View>

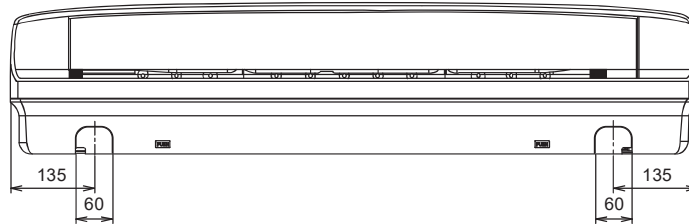

<Remote Control>

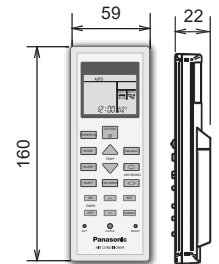

<Rear View>

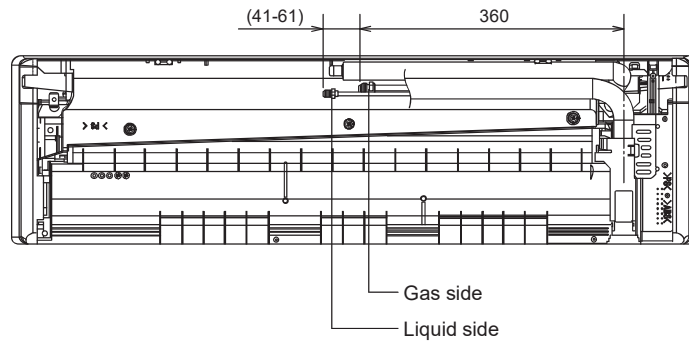

<Remote Control Holder>

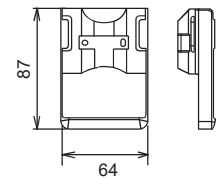

Relative position between the indoor unit and the installation plate <Front View>

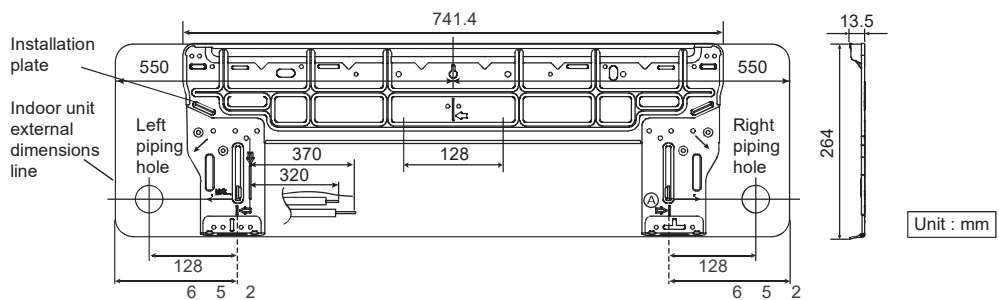

2 Outdoor Unit

2.1 CU-N18ZKH-8 / CU-N24ZKH-8

