

Dimensions

1 Indoor Unit

1.1 CS-XZ9XKH-8 / CS-XZ12XKH-8

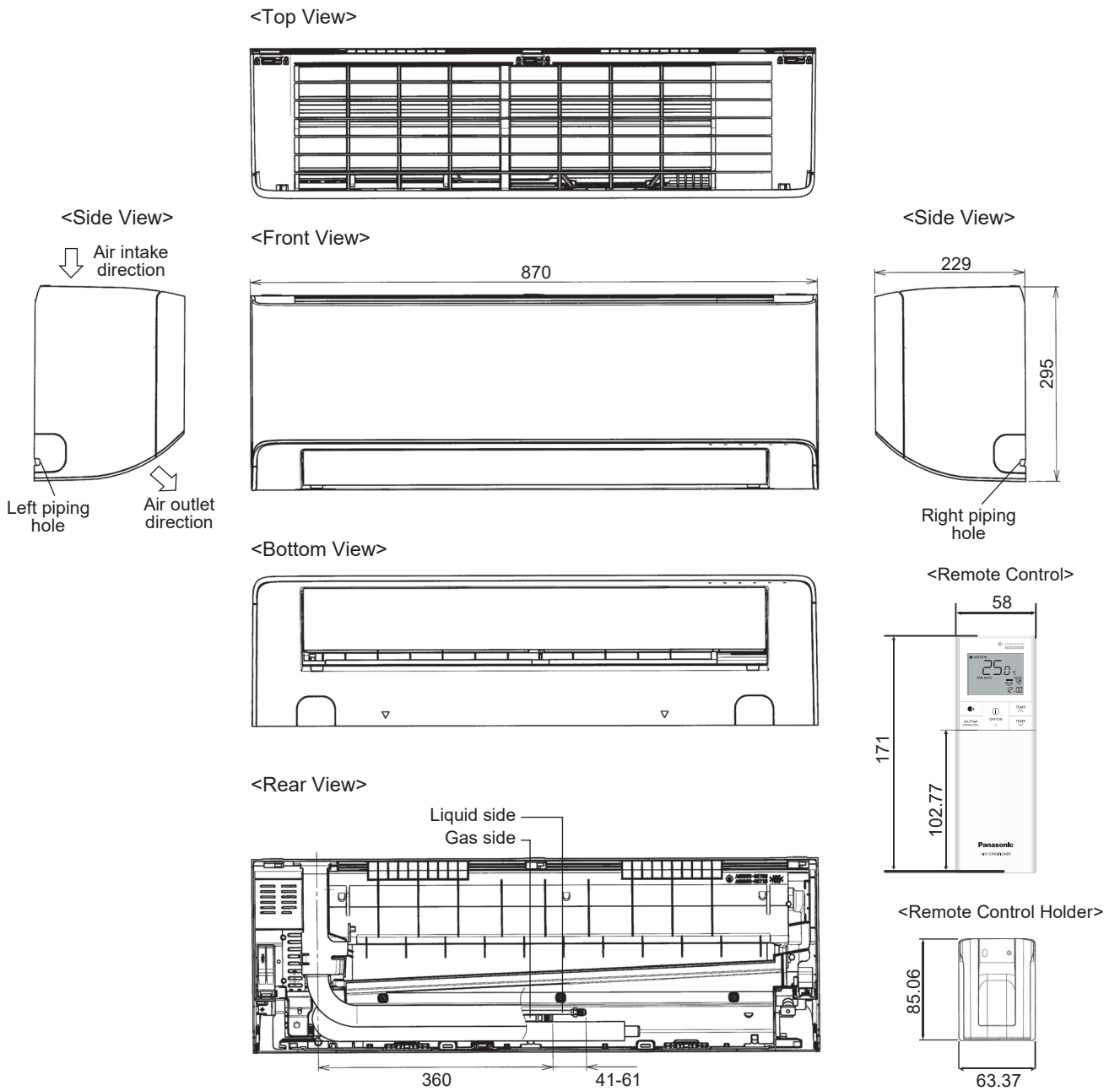

Relative position between the indoor unit and the installation plate <Front View>

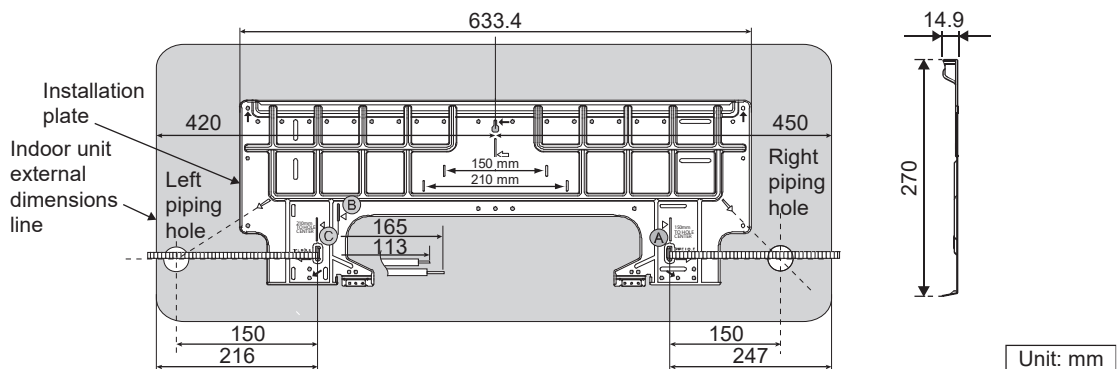

1.2 CS-XZ18XKH-8 / CS-XZ24XKH-8

<Top View>

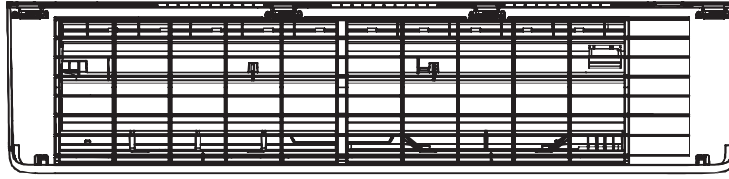

<Side View>

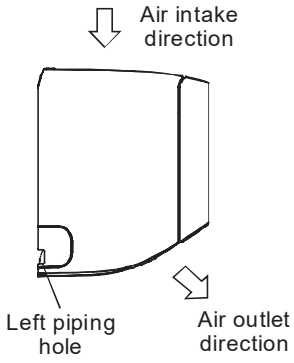

<Front View>

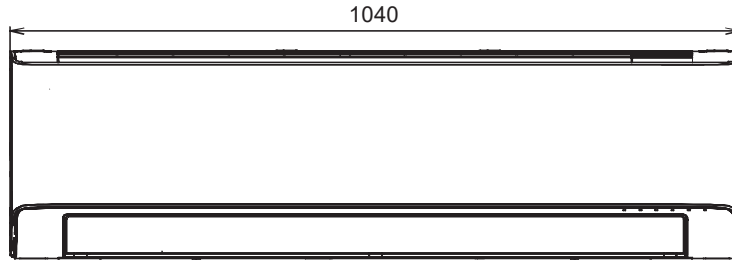

<Side View>

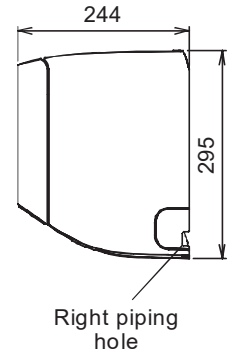

<Bottom View>

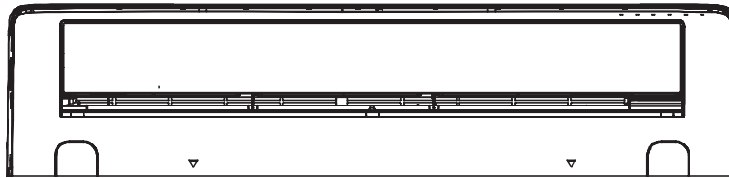

<Remote Control>

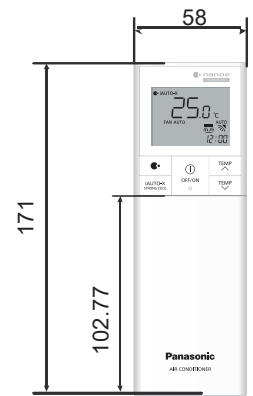

<Rear View>

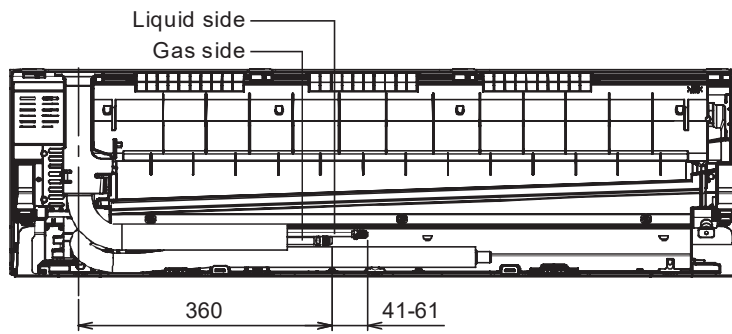

<Remote Control Holder>

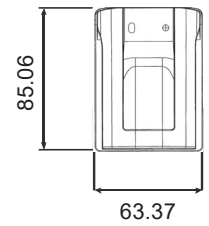

Relative position between the indoor unit and the installation plate <Front View>

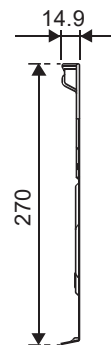
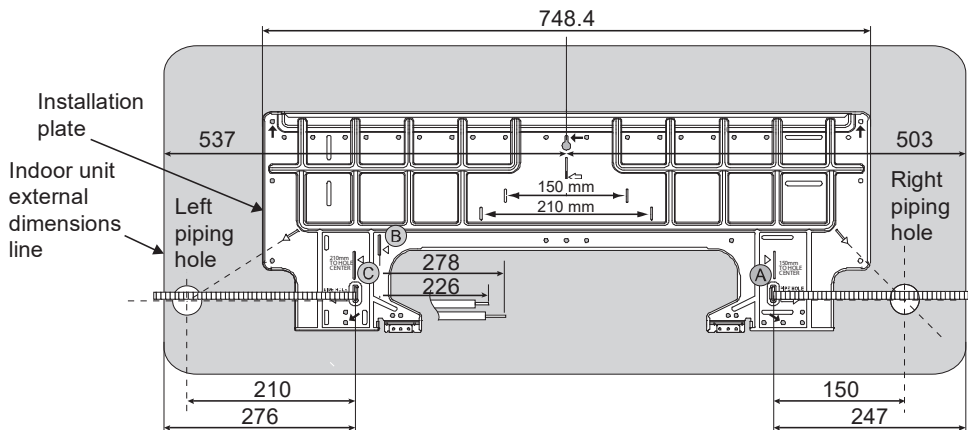

Unit: mm

2 Outdoor Unit

2.1 CU-XZ9XKH-8 / CU-XZ12XKH-8

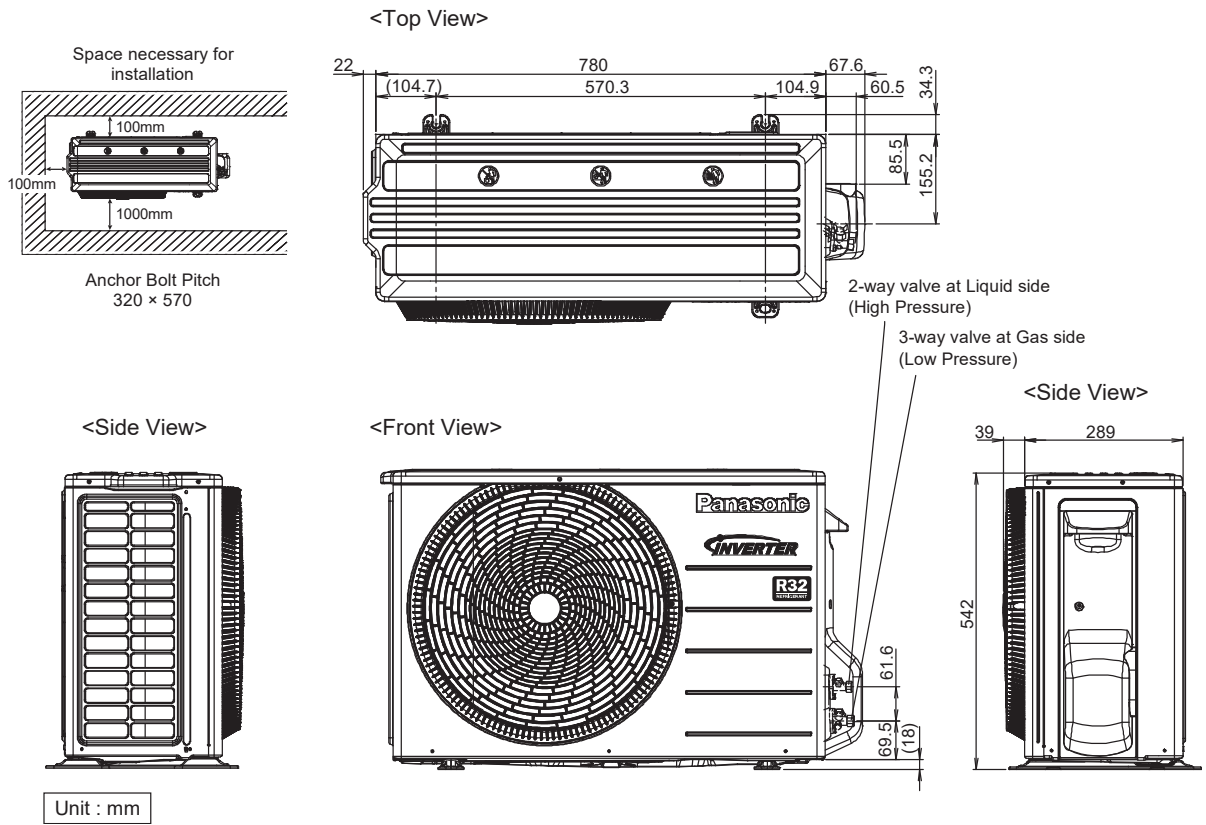

2.2 CU-XZ18XKH-8 / CU-XZ24XKH-8

