

Kích thước

1 Dàn lạnh

1.1 CS-PU9XKH-8M / CS-PU12XKH-8M / CS-PU18XKH-8M

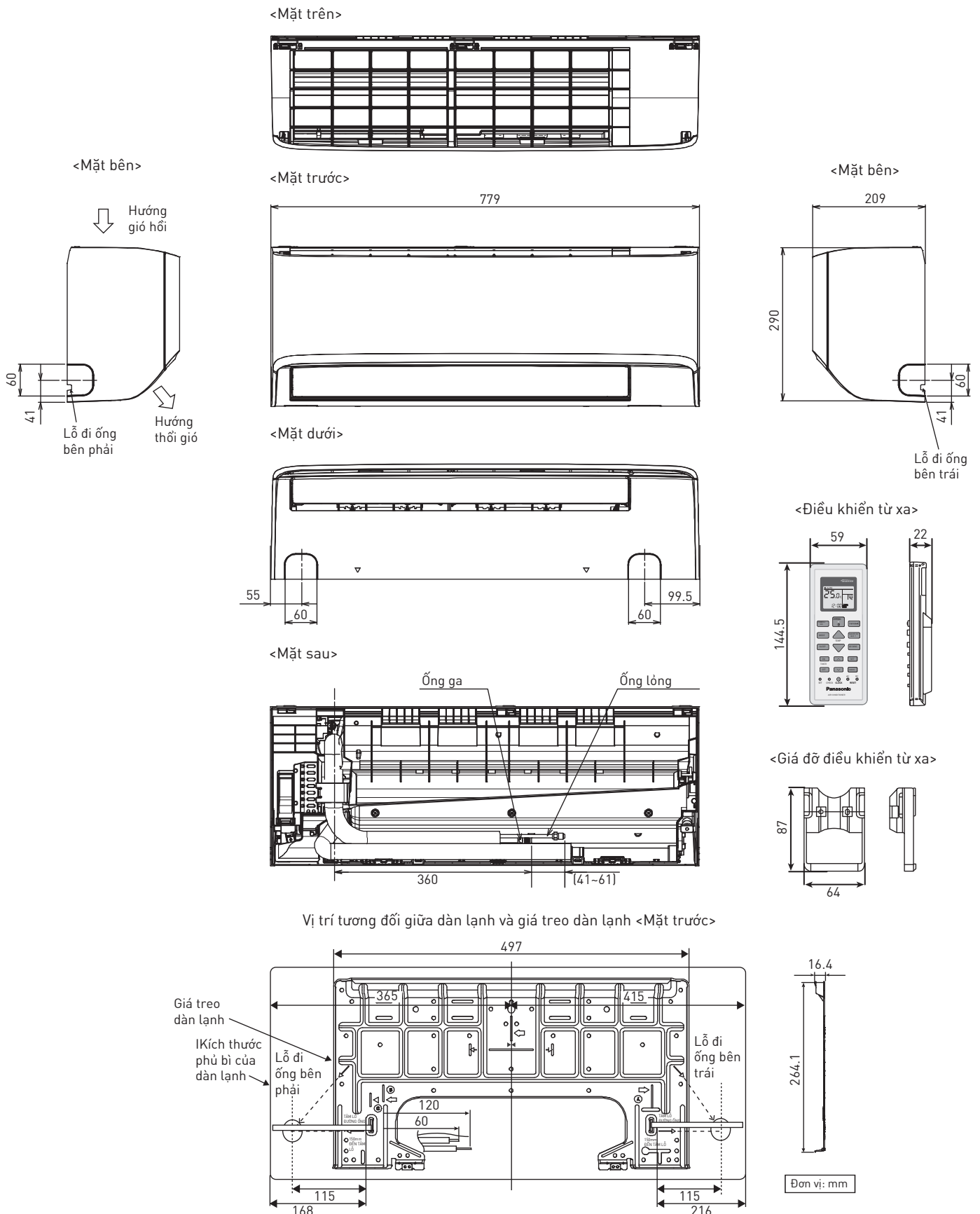

1.2 CS-PU24XKH-8M

<Mặt trên>

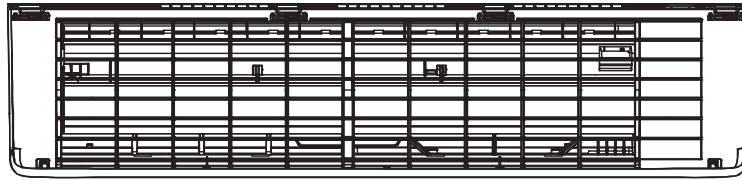

<Mặt bên>

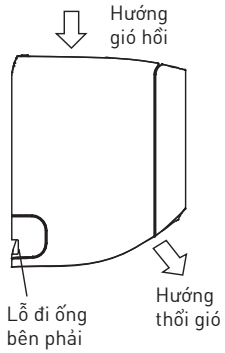

<Mặt trước>

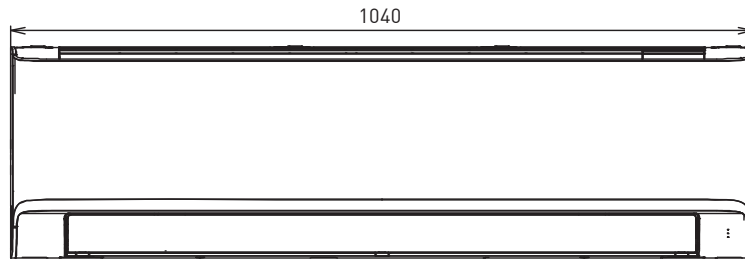

<Mặt bên>

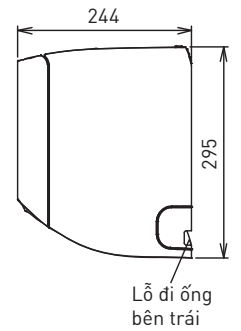

<Mặt dưới>

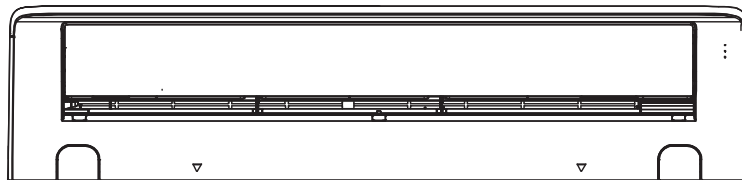

<Điều khiển từ xa>

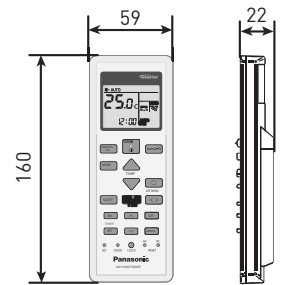

<Mặt sau>

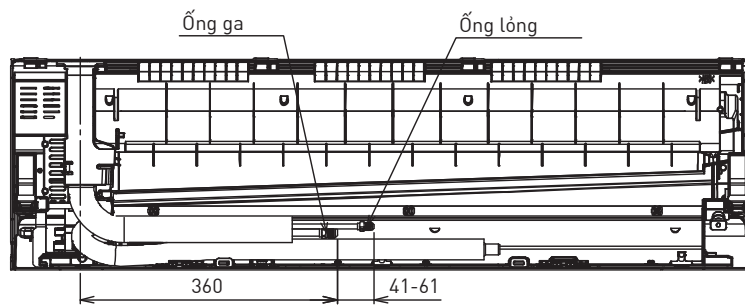

<Giá đỡ điều khiển từ xa>

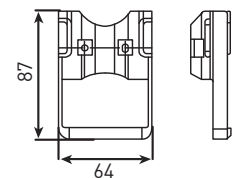

Vị trí tương đối giữa dàn lạnh và giá treo dàn lạnh <Mặt trước>

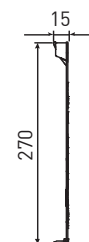
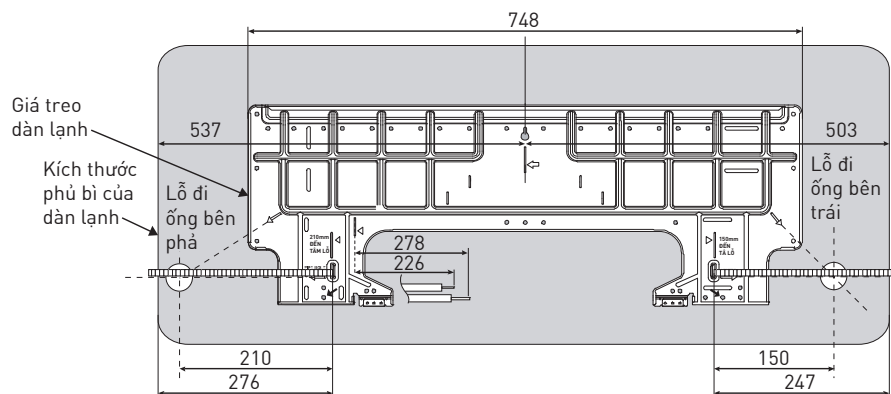

Đơn vị: mm

2 Dàn nóng

2.1 CU-PU9XKH-8M

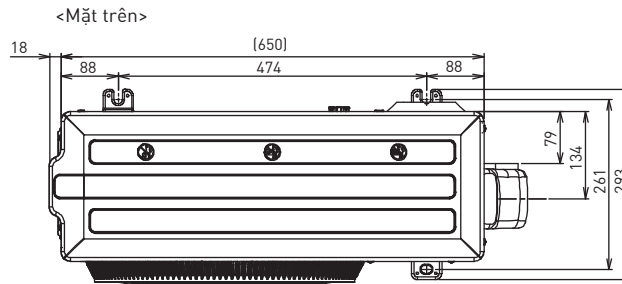
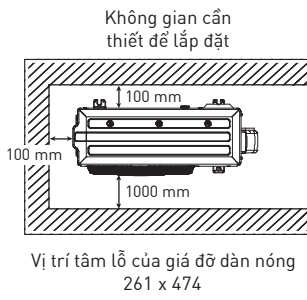

<Mặt bên>

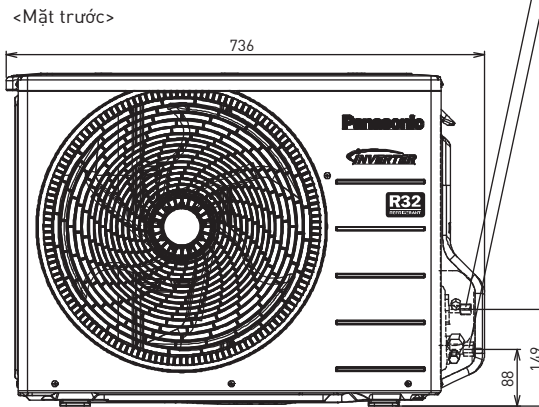
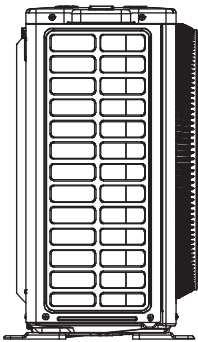

Van 2 ngã ở ống lỏng
(Áp suất cao)

Van 3 ngã ở ống ga
(Áp suất thấp)

<Mặt bên>

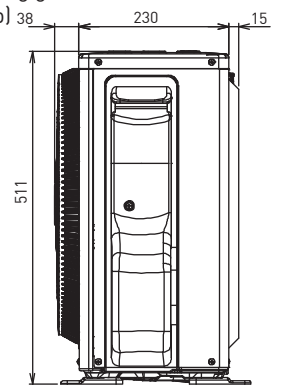

Đơn vị: mm

2.2 CU-PU12XKH-8M

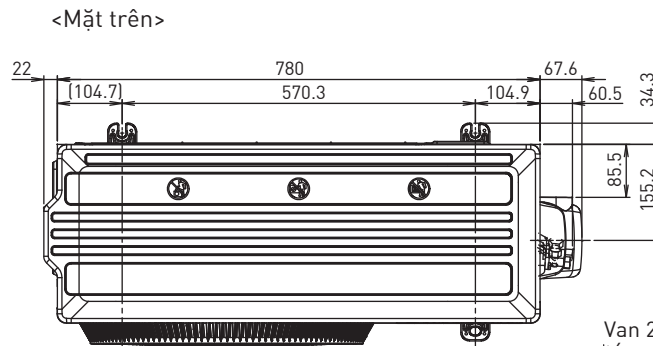
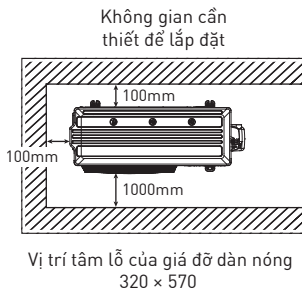

<Mặt bên>

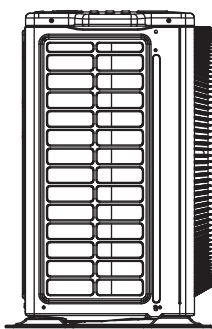

<Mặt trước>

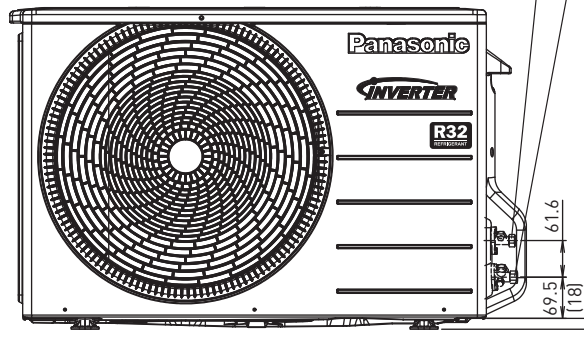

Van 2 ngã ở ống lỏng
(Áp suất cao)

Van 3 ngã ở ống ga
(Áp suất thấp)

<Mặt bên>

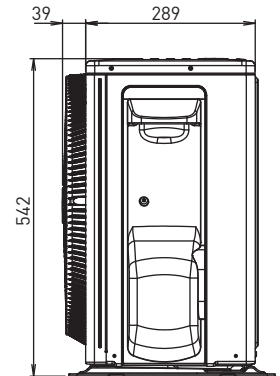

Đơn vị: mm

2.3 CU-PU18XKH-8M / CU-PU24XKH-8M

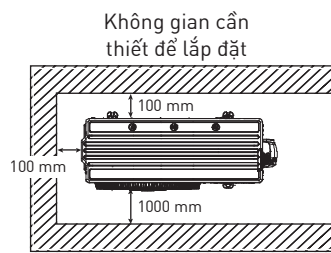

Kích thước phủ bì của dàn lạnh
330 x 540

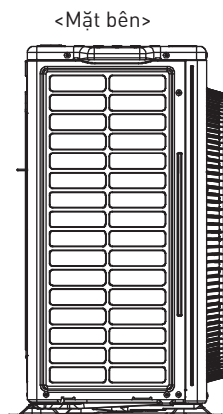
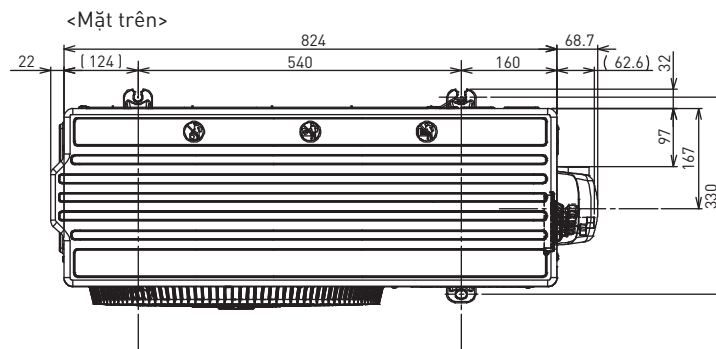

Đơn vị: mm

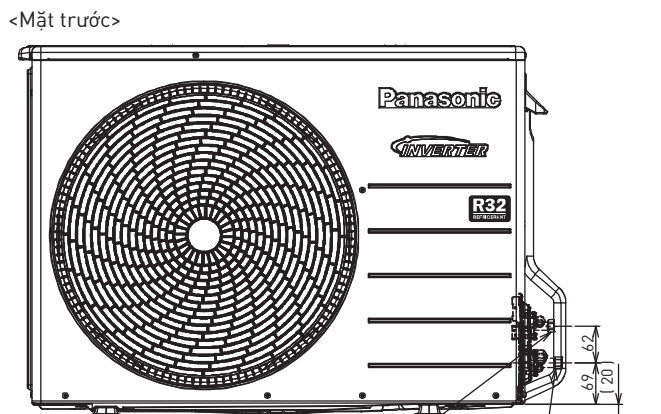

Van 2 ngã ở ống lỏng
(Áp suất cao)

Van 3 ngã ở ống ga
(Áp suất thấp)

