

# Kích thước

## 1 Dàn lạnh

### 1.1 CS-XPU18XKH-8B / CS-XPU24XKH-8

<Mặt trên>

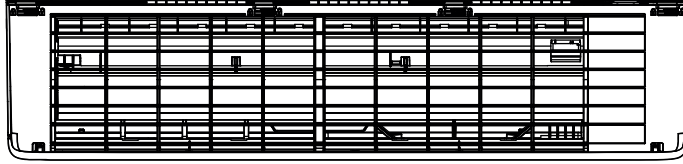

<Mặt bên>

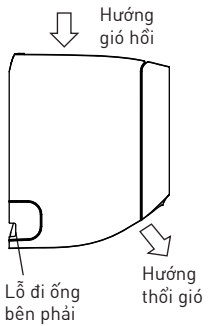

<Mặt trước>

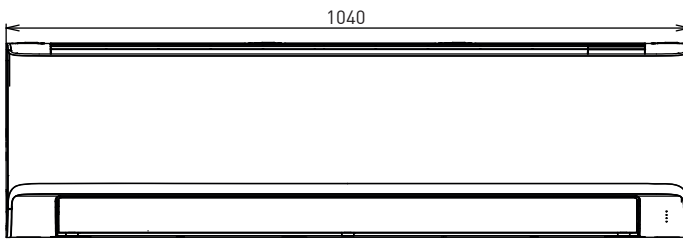

<Mặt bên>

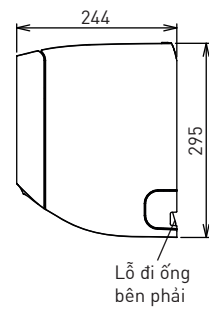

<Mặt dưới>

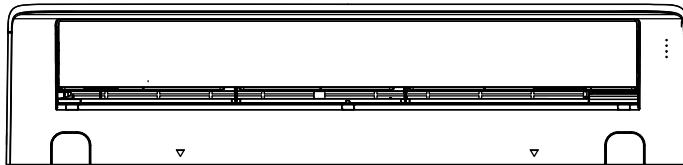

<Điều khiển từ xa>

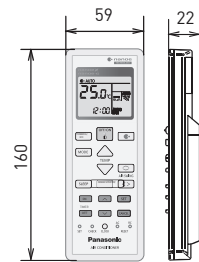

<Mặt sau>

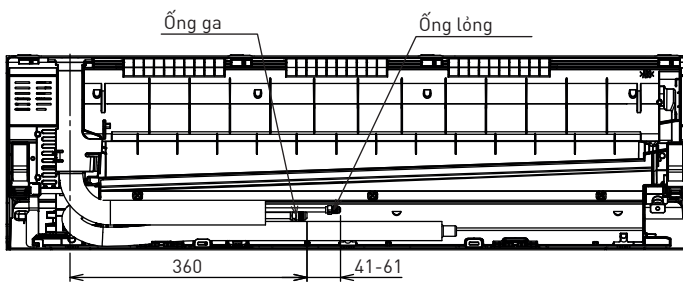

<Giá đỡ điều khiển từ xa>

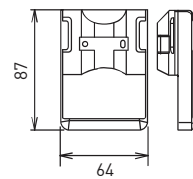

Vị trí tương đối giữa dàn lạnh và giá treo dàn lạnh <Mặt trước>

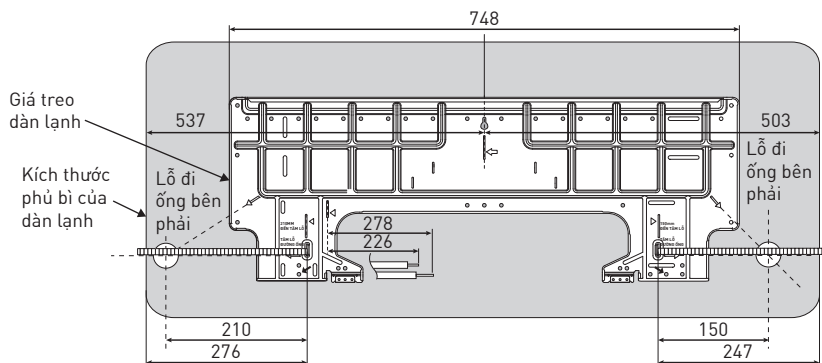

Đơn vị: mm

## 2 Dàn nóng

### 2.1 CU-XPU18XKH-8B / CU-XPU24XKH-8

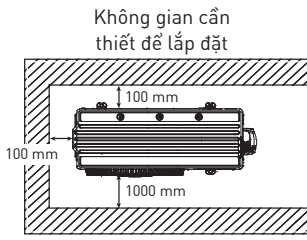

Vị trí tâm lỗ của giá đỡ dàn nóng  
330 x 540

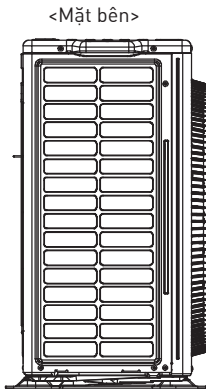
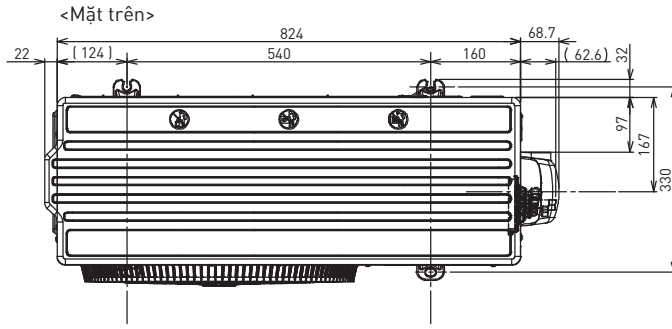

Đơn vị: mm

