

Panasonic®

INSTALLATION AND OPERATING INSTRUCTIONS Remote Control for Energy Recovery Ventilator (ERV) Model No. FV-SWGR1

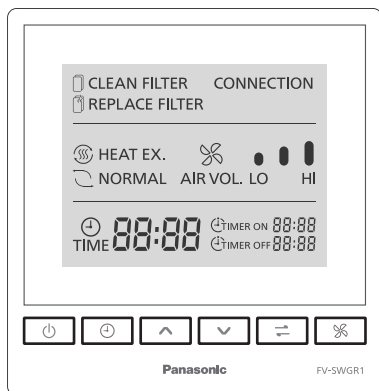

CONTENTS

SAFETY INSTRUCTIONS	2
INSTALLATION INSTRUCTIONS	2~3
INSTALLATION AND OPERATING REQUIREMENTS	4
SUPPLIED ACCESSORIES.....	4
PART NAMES AND DIMENSIONS.....	4
HOW TO INSTALL	5~7
TEST RUN	7
RS485 CONNECTION SETTINGS	7~8
LIST OF REGISTER ADDRESSES	8~10
KEY FUNCTIONS AND DISPLAY DESCRIPTION	10~11
OPERATION.....	11~12
USE AND MAINTENANCE INSTRUCTIONS.....	12
TROUBLESHOOTING.....	13
WIRING DIAGRAM	13
SPECIFICATIONS.....	14

Thank you for purchasing this **Panasonic** product.

Please read these instructions carefully before attempting to install, operate or service the **Panasonic** product.

Please carefully read "INSTALLATION INSTRUCTIONS" (P.2~3) of this instructions before installation. Failure to comply with instructions could result in personal injury or property damage. Please explain to users how to operate and maintain the product after installation, and this booklet should be presented to users. Please carefully read "USE AND MAINTENANCE INSTRUCTIONS" (P.12) of this instructions before operation. Please retain this booklet for future reference.

SAFETY INSTRUCTIONS

Please observe strictly

- Disconnect power supply before maintenance.
- This product is not intended for use by persons (including children) with reduced physical, sensory or mental capabilities, or lack of experience and knowledge, unless they have been given supervision or instruction concerning use of the product by a person responsible for the safety. Children should be supervised to ensure that they do not play with the product.
- If the supply cord is damaged, it must be replaced by manufacturer or its service agent or a similarly qualified person in order to avoid a hazard.

The following instructions should be strictly observed in order to prevent injury to the users and other people, or damage to property.

- The degrees of injury or damage that can occur when the instructions are ignored and if the product is not used properly have been classified and described by the following indications.



WARNING

This indication means: Must be treated seriously that this may result in death or serious injury.



CAUTION

This indication means: Must be treated seriously that this may result in injury or physical damage.

- Types of instructions that should be observed have been classified and described by the following pictorial symbols.



This symbol indicates the item is "PROHIBITED" to do.



This symbol indicates the "COMPULSORY" item that must be followed without failure.

INSTALLATION INSTRUCTIONS



WARNING

- Please stop the operation and cut off the power supply immediately if an abnormality occurs. Please contact the dealer where you purchased the product.
 - ! Otherwise, it may cause an electric shock or risk of fire.
- Be sure to entrust a professional to install the product securely.
 - ! Otherwise, it may cause an electric shock or risk of fire.
- Do not install the product in a place where combustible gas may leak.
 - ! Otherwise, it may result in a fire.

INSTALLATION INSTRUCTIONS

WARNING

- Please use fixed wiring with a nominal cross-sectional area of 1.5 mm² per core and a rated voltage of 300 V/500 V or less as the control wire between the power cord and the ERV.
 - ❗ Otherwise, it may result in fire.
- Do not connect cables using methods other than those specified in this manual.
 - ❗ Otherwise, it may cause an electric shock.
- Do not install the product in a bathroom or other high-humidity areas.
 - ⊘ Otherwise, it may pose a risk of fire or electric shock.
- Do not use wet hands to operate or pour water over the product.
 - ⊘ Otherwise, it may cause an electric shock.
- Always isolate the power supply to all the circuits before touching the terminals or wiring.
 - ❗ Otherwise, it may cause an electric shock.
- Never modify or repair the product by yourself. Please contact the dealer where you purchased the product.
 - ⊘ Otherwise, it may cause an electric shock or risk of fire.
- Never use any power supply other than the one with the rated voltage.
 - ⊘ Otherwise, it may pose a risk of fire or an electric shock.
- Do not spray combustibles directly onto the product.
 - ⊘ Otherwise, it may result in a fire.

CAUTION

- Gloves should be worn during installation.
 - ❗ Otherwise, it may cause scratches.
- Be sure to connect wires as specified in the Wiring Diagram.
 - ❗ Otherwise, it may cause damage to the controller, the ERV or the RS485-linked relay.
- Always use the supplied special-purpose or dedicated parts like mounting fixtures when needed.
 - ❗ Otherwise, the product may fall off, and thus cause injury.
- Do not press the screen of the product.
 - ❗ Otherwise, it may cause faults, screen breakage, etc.

INSTALLATION AND OPERATING REQUIREMENTS

- The remote control can link up to 10 energy recovery ventilators.
- The mounting surface should be as flat as possible to prevent deformation of the product. (If the wall is not flat, the LCD screen may be damaged, or faults may occur.)
- If the installation position is too high or too low, you may not be able to see the LCD screen clearly. It is recommended that the product be mounted 1.5 m or so above the ground for clear vision. For users with physical disabilities and wheelchair users, the height may need to be adjusted accordingly in line with local regulations.
- The remote control with the RS485 function shall be at least 1 m away from TV sets, broadcast radios, computers, etc. (Otherwise, it may cause distorted or skewed images or noises.)
- The switch box required for installation always keeps in mind the appearance specifications of the remote control, and ensure that the switch box you bought can match the remote control.
Recommended exterior dimensions: $\geq 102 \text{ mm} \times 102 \text{ mm} \times 35 \text{ mm}$ (H x W x D).

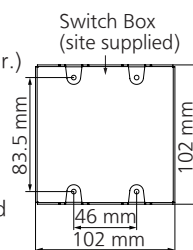

SUPPLIED ACCESSORIES

The product comes with the following accessories. After unpacking the packing case, check that all items are included. If anything is missing, please contact your dealer.

No.	①	②	③
Figure			
Name	Remote Control	Screws (M4x20)	Installation and Operating Instructions
Quantity	1	4	1

PART NAMES AND DIMENSIONS

Outside view

Unit: mm

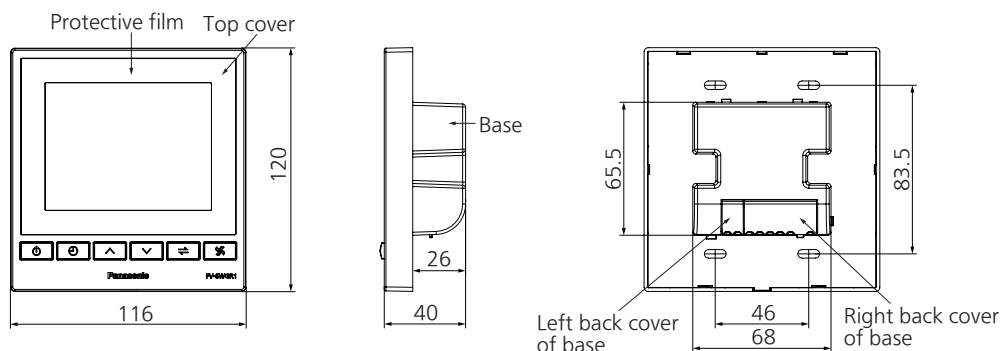

HOW TO INSTALL

1-1. Connect the wire

Draw out the control wire from the switch box, open the right back cover of the base, and connect the wire as illustrated in the Wiring Diagram. For details, please refer to the following figure or the attached Wiring Diagram. Finally, close the right back cover after checking that the wire is securely connected.

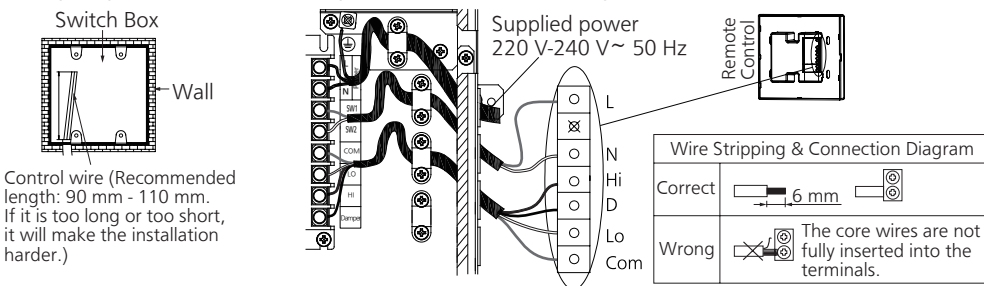

1-2. Disassemble the top cover

Insert a flat-head screwdriver into the groove as shown in the right figure, pry off the top cover, and remove gently.

Notice

Note that the top cover is connected to the base with a flexible flat cable. Do not pull hard, or the cable may become damaged.

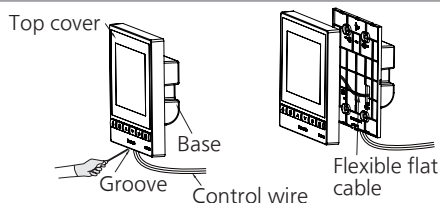

1-3. Fix the base into the switch box

Check that the flexible flat cable is not loose, and put the base into the switch box. Pay attention to the direction of the base (↑ UP indicates upward). Fix the base with the four supplied screws. Be careful not to over-tighten the screws because it could cause damage or deformation to the resin shell.

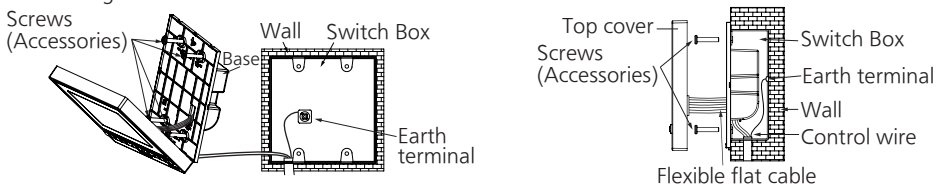

1-4. Fix the top cover

Fix the top cover to the base, close the upside snap joint bayonet first and then the downside one, as indicated by the arrow.

Upside snap joint bayonet

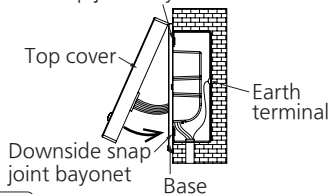

Notice

Do not press the LCD screen or damage to the screen may occur.

CAUTION

■ While installing the top cover, please make sure that the internal flexible flat cable is not caught by the circuit board or resin.



In case the pinched sheath is broken, current leakage may occur.

HOW TO INSTALL (RS485 CONNECTION)

2-1. Connect the wire

Low voltage connection (where the remote control is connected to the ERV): Refer to "1-1. Connect the wire" in the section "How to Install".

Extra-low voltage connection (where the remote control is connected to RS485): Open the left back cover, and refer to the figure below or the attached Wiring Diagram for details.

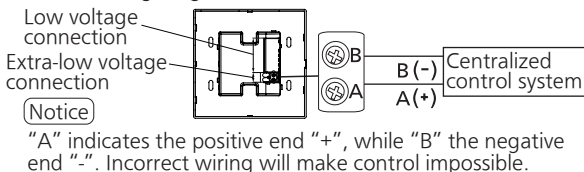
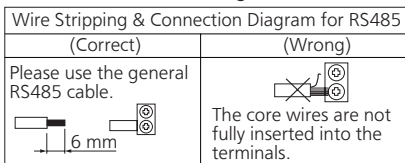

2-2. Disassemble the top cover

Refer to "1-2. Disassemble the Top Cover" in the section "How to Install".

2-3. RS485 Connection Settings

Terminal resistance setting

The terminal resistance of the RS485 unit is OFF by default (as shown in figure on the right). Do not turn it on if the wire connecting the product to the centralized control system is less than 200 m; but turn it on if the wire is 200 m or greater (Keeping it OFF may result in communication failure).

Notice

Terminal resistance: 120 Ω.

This value also applies to the relay.

To adjust the terminal resistance and machine address, please use a small flat-head screwdriver.

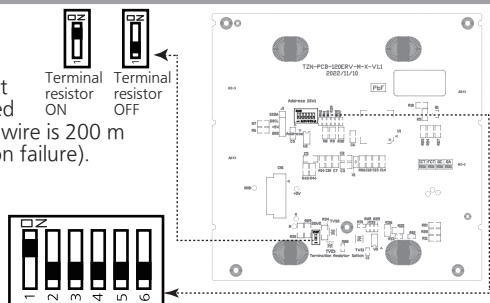

Machine address setting

DIP SW 6 bits for setting the machine address.

By default, the address is set to 1. (x: OFF ○: ON)

*Write down the address set for future reference.

List of the machine addresses																				
Address	DIP SW						Address	DIP SW						Address	DIP SW					
	1	2	3	4	5	6		1	2	3	4	5	6		1	2	3	4	5	6
1	○	x	x	x	x	x	22	x	○	○	x	○	x	43	○	○	x	○	x	○
2	x	○	x	x	x	x	23	○	○	○	x	○	x	44	x	x	○	○	x	○
3	○	○	x	x	x	x	24	x	x	x	○	○	x	45	○	x	○	○	x	○
4	x	x	○	x	x	x	25	○	x	x	○	○	x	46	x	○	○	○	x	○
5	○	x	○	x	x	x	26	x	○	x	○	○	x	47	○	○	○	○	x	○
6	x	○	○	x	x	x	27	○	○	x	○	○	x	48	x	x	x	x	○	○
7	○	○	○	x	x	x	28	x	x	○	○	○	x	49	○	x	x	x	○	○
8	x	x	x	○	x	x	29	○	x	○	○	○	x	50	x	○	x	x	○	○
9	○	x	x	○	x	x	30	x	○	○	○	○	x	51	○	○	x	x	○	○
10	x	○	x	○	x	x	31	○	○	○	○	○	x	52	x	x	○	x	○	○
11	○	○	x	○	x	x	32	x	x	x	x	x	○	53	○	x	○	x	○	○
12	x	x	○	○	x	x	33	○	x	x	x	x	○	54	x	○	○	x	○	○
13	○	x	○	○	x	x	34	x	○	x	x	x	○	55	○	○	x	○	○	○
14	x	○	○	○	x	x	35	○	○	x	x	x	○	56	x	x	x	○	○	○
15	○	○	○	○	x	x	36	x	x	○	x	x	○	57	○	x	x	○	○	○
16	x	x	x	x	○	x	37	○	x	○	x	x	○	58	x	○	x	○	○	○
17	○	x	x	x	○	x	38	x	○	○	x	x	○	59	○	○	x	○	○	○
18	x	○	x	x	○	x	39	○	○	○	x	x	○	60	x	x	○	○	○	○
19	○	○	x	x	○	x	40	x	x	x	○	x	○	61	○	x	○	○	○	○
20	x	x	○	x	○	x	41	○	x	x	○	x	○	62	x	○	○	○	○	○
21	○	x	○	x	○	x	42	x	○	x	○	x	○	63	○	○	○	○	○	○

HOW TO INSTALL (RS485 CONNECTION)

2-4. Fix the base into the switch box

Refer to "1-3. Fix the base into the switch box" in the section "How to Install".

2-5. Fix the top cover

Refer to "1-4. Fix the Top Cover" in the section "How to Install".

TEST RUN

When installation is complete, turn on the power, press each of the function keys on the remote control to check if the ERV works correctly. If the ERV does not operate, please check if the power supply is terminated correctly and securely.

RS485 CONNECTION SETTINGS

Specifications

Information transfer mode	Start-stop synchronous mode; start bit: 1bit; data bit: 8bit; stop bit: 1bit; parity check bit: null
Check Field	Adopt the 16-bit CRC (Cyclic Redundancy Check) in the MODBUS-RTU mode.
Basic form of protocol	Modbus frame structure
Address bar	Valid scope of the address: 1-63
Data zone	Byte order used in the Modbus data zone: Big-Endian. (High-order byte → Low-order byte)
Data transfer rate	9600 bps

RS485 CONNECTION SETTINGS

Communication frame structure

	①	②	③	④	⑤	⑥
Name	Start	Machine address	Function code	Data	Check code	End
Number of bytes	Default interval	1	1	n	2	Default interval

① Start: Set a default range of 3.65 ms or more between signals (without communication time).

② Machine address: Specify a machine address to connect the RS485 module. (Refer to "List of the machine addresses" for the setting method.)

③ Function code:

Function code	Content	Function description
0x03	Reading register	Reads register values.
0x06	Writing register	Writes a (single) set value.
0x10	Writing complex register	Writes a (complex) set value.

④ Data: The composition of the data section varies with the function code and register address. (Refer to "Cases of Setting Communication Framework".)

⑤ Check code: The calculated value of a 16-bit CRC in the Modbus-RTU mode.

• For CRC calculation, refer to below:

1. Preset a 16-bit register as 0FFFFH (all 1s), which is called a CRC register.
2. Perform an exclusive-or (XOR) operation between the 8 bits of the first byte in the data frame and the low byte in the CRC register, and store the result back to the CRC register.
3. Shift the CRC register one bit to the right, put a 0 in the most significant bit, shift out the least significant bit, and perform a detection.
4. If the least significant bit is 0: repeat Step 3 (for the next bit shift); if the least significant bit is 1: perform an exclusive-or (XOR) operation between the CRC register and the preset fixed value (0A001H).
5. Repeat Steps 3 and 4 until 8 bit shifts are performed. This completes the bit manipulation of an 8-bit byte.
6. Repeat Steps 2 through 5 to manipulate the next 8 bits until all byte manipulations are complete.
7. The final value of the CRC register is the CRC value.

⑥ End: Set a default range of over 3.65 ms between signals (without communication time).

LIST OF REGISTER ADDRESSES

■ Below is a list of register addresses used by the RS485 module for communication.

Register address	Data name	Function code	Read/Write	Data length [Byte]	Type	Data value
0x0001	Running state	0x03	R/W	2	UINT16	0x00: OFF
		0x06				0x01: ON
		0x10				0xFF: set Skip (keep the current setting)
0x0002	Running mode	0x03	R/W	2	UINT16	0x00: Heat exchange
		0x06				0x01: Normal ventilation
		0x10				0xFF: set Skip (keep the current setting)

LIST OF REGISTER ADDRESSES

Register address	Data name	Function code	Read/Write	Data length [Byte]	Type	Data value
0x0003	Air volume	0x03	R/W	2	UINT16	0x01: Low
		0x06				0x03: High
		0x10				0xFF: set Skip (keep the current setting)
0x000B	The time remaining to clean the filter	0x03	R	2	UINT16	0~720 h
0x000D	The time remaining to replace the filter	0x03	R	2	UINT16	0~2880 h
0x000E	Reservation *3	0x03	R/W	1 (Low-order byte)	UINT8	0xFF: set Skip (keep the current setting)
	Filter replacement cycle	0x06 0x10		1 (High-order byte)		UINT8
0x0011 *1	TIMER ON setting (Hours)	0x03 0x10	R/W	1 (Low-order byte)	UINT8	0x00~0x17: 0-23 hours 0x7F: no valid data
	TIMER ON setting (Minutes)			1 (High-order byte)		UINT8
0x0012 *1	TIMER ON	0x03 0x10	R/W	1 (Low-order byte)	UINT8	0x00: OFF 0x01: ON 0xFF: set Skip (keep the current setting)
	TIMER OFF			1 (High-order byte)		UINT8
0x0013 *1	TIMER OFF setting (Hours)	0x03 0x10	R/W	1 (Low-order byte)	UINT8	0x00~0x17: 0-23 hours 0x7F: no valid data
	TIMER OFF setting (Minutes)			1 (High-order byte)		UINT8
0x0015 *2	Reservation *3	0x10	W	1 (Low-order byte)	UINT8	0xFF: set Skip (keep the current setting)
	Network time (Minutes)			1 (High-order byte)		UINT8
0x0016 *2	Network time (Hours)	0x10	W	1 (Low-order byte)	UINT8	0x00~0x17: 0-23 hours 0xFF: set Skip (keep the current setting)
	Reservation *3			1 (High-order byte)		UINT8

The range of continuously accessible complex register addresses is as follows:

Read (function code 0x03): 0x0001~0x0003, 0x000B, 0x000D, 0x000E, 0x0011~0x0013

Write (function code 0x10): 0x0001~0x0003, 0x000E, 0x0011~0x0013, 0x0015~0x0016

*1 Use the function code 0x03 to read the complex register address (0x0011 to 0x0013) together.

Use the function code 0x10 to write the complex register address (0x0011 to 0x0013) together.

*2 Use the function code 0x10 to write the complex register address (0x0015 to 0x0016) together.

*3 It is a reserved data field. The reading value and writing value are invalid.

Note: Do not access undefined register addresses.

■ Network settings

By default, RS485 is set to ON.

The **CONNECTION** icon flashes rapidly: The Intranet connection is underway; The **CONNECTION** icon stays solid on: The Intranet connection is successful.

The **CONNECTION** icon goes off: No valid network signal has been detected (Possible causes: The centralized control system did not send any valid signal; the communication line is wrongly connected, or the line is broken; the RS485 function is disabled). In the event of an error check integrity of communication wiring and wiring termination.

(Notice)

1. Please set the data sending interval of the Modbus main node (centralized control system) to less than 1 minute to ensure a smooth network connection.

2. Press and hold the TIME key and the  key at the same time for 3 seconds to disable or enable the RS485 function.

• If the **CONNECTION** icon flashes slowly three times and then goes off, the RS485 function is disabled.

• If the **CONNECTION** icon flashes rapidly or stays solid on, the RS485 function is enabled.

LIST OF REGISTER ADDRESSES

Cases of Setting Communication Framework for the RS485 Device

When reading and writing the data of register addresses 0x0011 to 0x0013 for a device with 0x01 as its machine address.

Register address	0x0011: Set the time for TIMER ON.
	0x0012: Set TIMER ON/Cancel the timer.
	0x0013: Set the time for TIMER OFF.

Centralized control system → Controller (Reading the function code 0x03)

Machine address	Function code	Start address		Read quantity		Check code	
		High order	Low order	High order	Low order	Low order	High order
0x01	0x03	0x00	0x11	0x00	0x03	0x55	0xCE

Controller → Centralized control system (Reading feedback)

Machine address	Function code	Size of the data read	Data 1		Data 2		Data 3		Check code	
			High order	Low order	High order	Low order	High order	Low order	Low order	High order
0x01	0x03	0x06	0x01	0x10	0x01	0x01	0x3B	0x12	0x22	0x66

Centralized control system → Controller (Writing the function code 0x10)

Machine address	Function code	Start address		Write quantity		Size of the data	Data 1		Data 2		Data 3		Check code	
		High order	Low order	High order	Low order		High order	Low order	High order	Low order	High order	Low order	High order	
0x01	0x10	0x00	0x11	0x00	0x03	0x06	0x01	0x10	0x01	0x01	0x3B	0x12	0xB5	0xC3

Controller → Centralized control system (Writing feedback)

Machine address	Function code	Start address		write quantity		Check code			
		High order	Low order	High order	Low order	Low order	High order		
0x01	0x10	0x00	0x11	0x00	0x11	0x00	0x03	0xD0	0xD0

Error code response example

Machine address	Function code	Data	Check code	
		Error code	Low order	High order
0x01	*1	*2	Low-order data	High-order data

*1 The function code received by the RS485 module +0x80

*2 Error code content

Error code	Content	Description
0x01	Bad function code	An incorrespondent function code is specified.
0x02	Bad register code	A register address not covered in the list of register addresses is specified.
0x03	Bad request quantity	Inconsistent data quantity is specified.

KEY FUNCTIONS AND DISPLAY DESCRIPTION

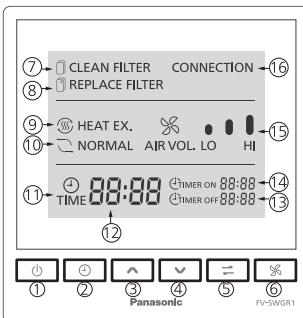

* If controller is not operated for 1 minute or longer the LCD backlight will go out. Press any key to turn the LCD backlight on.

No.	Name	Function
①	Standby key	ERV running/standby switchover
②	TIME key	Adjusts the clock and sets the TIMER ON/TIMER OFF function.
③	" ^ " key	Increases the time setting of the clock and the TIMER ON/TIMER OFF function; selects the mode of the clock and the TIMER ON/TIMER OFF function.
④	" ~ " key	Decreases the time setting of the clock and the TIMER ON/TIMER OFF function; selects the mode of the clock and the TIMER ON/TIMER OFF function.

KEY FUNCTIONS AND DISPLAY DESCRIPTION

No.	Name	Function
⑤	Heat exchange/ Normal ventilation key	Switches between heat exchange and normal ventilation.
⑥	Air volume key	Switches between the high and low volume.
⑦	CLEAN FILTER indicator	When the ERV has run for 720 hours, 1440 hours and 2160 hours, the CLEAN FILTER indicator flashes. In this case, press the “^” and “~” keys simultaneously for more than 3 seconds to clear the CLEAN FILTER indicator.
⑧	REPLACE FILTER indicator	When the ERV has run for 2880 hours, the REPLACE FILTER indicator flashes. In this case, press the “^” and “~” keys simultaneously for more than 3 seconds to clear the REPLACE FILTER indicator.
⑨	Heat exchange indicator	Shows the heat exchange mode of the ERV.
⑩	Normal ventilation indicator	Shows the normal ventilation mode of the ERV.
⑪	TIME indicator	If the local time is not set, the TIME indicator flashes. When you have set the local time, the TIME indicator stays solid on.
⑫	Clock time display	If the local time is not set, the clock time display flashes. After the local time is set, the local time is displayed all the time. When the ERV has run for 720 hours, 1440 hours and 2160 hours, F-1, F-2 and F-3 are displayed when the filter needs to be cleaned. When the ERV has run for 2880 hours, F-4 is displayed when the filter needs to be replaced. Press the “^” and “~” keys simultaneously for more than 3 seconds until the local time is displayed.
⑬	TIMER OFF indicator	Displays the actual time for turning off. The ERV will shut down when the time is reached.
⑭	TIMER ON indicator	Shows the actual time of turning on. The ERV will start when the time is reached.
⑮	Air volume indicator	Displays the air volume flow setting of the ERV. For the Low level, only the shortest of the three bars is displayed; for the High level, all the three bars are displayed. If no bar is lit, the ERV is disabled.
⑯	CONNECTION indicator	If the connection icon stays solid on, it means the RS485 has been connected. If the icon flashes rapidly, it indicates the RS485 is in the process of being connected; if the icon goes out, it shows that no valid network signal has been detected.

OPERATION

1. Power on/off

Press the Standby key to switch between the Running and Standby mode.

- The ERV starts in the last mode operated before switching off.





2. Shift the air volume



Press the AIR VOLUME key to shift the air flow volume between Hi and Lo.

3. Switch the ventilation mode

Press the HEAT EXCHANGE/NORMAL key to switch between heat exchange and normal ventilation.





4. Set the clock

- The initial time setting of the clock is 0:00.
- Long press the TIME key for 2 or more seconds until the TIME icon flashes on the LCD screen, and then press the TIME key again to enter the time setting mode.
- When the number for the hour flashes, press  or  to select the current time, and press the TIME key again to confirm the number of hours.
- When the number for the minute flashes, press  and  to select the current time, and press the TIME key again to confirm the number of minutes.
Then, press the TIME key once more to finish the setting.

Note: Each time you press  or  the number for the time increases or decreases by 1 hour or 1 minute, and press either key for 1.5 or more seconds for rapid increase/decrease of value.

When the CLEAN FILTER alert appears, the TIME indicator does not display. It will remain unlit until the cleaning and resetting is done.

5. Set the TIMER ON/OFF function

- TIMER ON and TIMER OFF are not available to set before the clock has been set.
- Press the TIME key for 2 or more seconds until the TIME icon flashes on the LCD screen, indicating that you can press  or  to select either TIMER ON or TIMER OFF. After that, press the TIME key again to enter the TIMER ON or TIMER OFF time setting.
- When the number for the hour flashes, press  or  to select a time for TIMER ON or TIMER OFF, and press the TIME key again to confirm the number of hours.

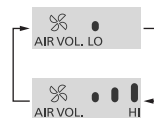

OPERATION

- When the number for the minute flashes, press or to select a time for TIMER ON or TIMER OFF, and press the TIME key again to confirm the number of minutes. After that, press the TIME key again to finalise the TIMER ON or TIMER OFF mode, and the TIMER ON/OFF indicator will stay solid on. The time set for TIMER ON/OFF is now set.
- While setting TIMER ON, you can press the AIR VOLUME key to set the air volume for the ERV after it starts. Note: Each time you press or , the number for the time increases or decreases by 1 hour or 1 minute, and press either key for 1.5 or more seconds for rapid increase/decrease of value.

6. Cancel the timer

Method①: Press TIME and simultaneously for 3 seconds to cancel the settings of both TIMER ON and TIMER OFF.

Method②: Set the hours or minutes of TIMER ON or TIMER OFF to “-”, to cancel TIMER ON or TIMER OFF respectively.

7. Clean the filter and reset the settings

When the filter requires cleaning, the CLEAN FILTER and TIME indicators act accordingly as stated in the table below.

CLEAN FILTER indicator	TIME indicator	Meaning	Remarks
CLEAN FILTER			
Flashing	F-1	The filter has been used for 1 month (720 hours).	Indicating the total running time of the ERV, excluding its stop time.
Flashing	F-2	The filter has been used for 2 months (1440 hours).	
Flashing	F-3	The filter has been used for 3 months(2160 hours).	

Having read the meanings in the above table, you can clean the filter by referring to the Installation and Operating Instructions for the ERV. After the cleaning, press and simultaneously for 3 seconds or above until the CLEAN FILTER indicator goes out and the present time is displayed as TIME. If the resetting is not done, the CLEAN FILTER and TIME alerts will continue.

■ If and do not turn on, please do not reset. Otherwise, the service duration of the filter will become 0.

8. Replace the filter and reset the settings

When flashes and TIME indicator displays F-4, the filter has been used for 4 months (2,880 hours). Please replace the filter. After the replacement, press and for 3 seconds or above until the REPLACE FILTER indicator goes out and the service duration of the filter will return to 0. The service time of the filter will be recalculated.

USE AND MAINTENANCE INSTRUCTIONS

WARNING

■ Disconnect power supply before maintenance.

Otherwise, it may cause an electric shock.

■ To relocate the remote control, please entrust the dealer where you purchased the product to reinstall it.

Otherwise, it may cause an electric shock or risk of fire.

■ Do not use wet hands to operate or pour water over the product.

Otherwise, it may cause an electric shock.

■ At the end of service life or when product is no longer required, in order to prevent accidental falls, be sure to dismount the product instead of leaving it unattended.

Otherwise, it may result in personal injury.

■ Do not spray combustibles directly onto the product.

Otherwise, it may cause a fire.

Notice

■ Wipe dirt carefully off the surface of the product with a cloth slightly dampened with neutral detergent, and wipe it dry with a dry and soft cloth.

■ Never clean the product with gasoline, diluent, benzene, abrasive powder, chemical cloth and spray insecticide. Otherwise, it may cause scratches or deformation.

TROUBLESHOOTING

Phenomenon	Solution
The product does not work after the standby switch is turned on.	Is the power supply connected? Is there a power failure?
The ERV does not act after the remote control is operated.	Is the power cord connection loose? Is the connection to the ERV correct? Is the wire connected to the ERV loose?

WIRING DIAGRAM

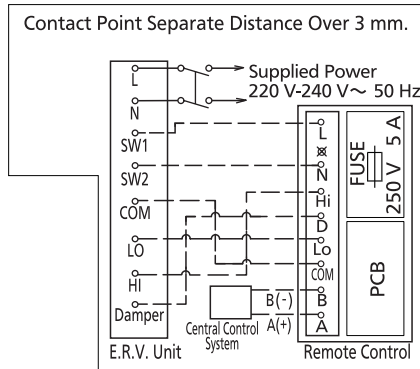

Note:

- The dotted lines in the diagram indicate wiring to be carried out on site by qualified professionals.
- Be sure to isolate the power supply before wiring.
- It's recommended to use the cable for connecting power main unit and switch, with a rated voltage of 300 V/500 V as stipulated in 60227 IEC 10 (fixed wiring). Cross-section area for each core wire is 1.5 mm².
- No more than 10 units can be connected, as over-current may result in fire.
- Protective gloves should be worn during installation.
- After the connection is complete, be sure to close the back cover of the remote control and confirm that it is clamped tightly.
- Please read the Installation and Operating Instructions carefully before wiring.

SPECIFICATIONS

Voltage and frequency	220 V-240 V~ 50 Hz
Rated power	2.0 W
Weight	0.26 kg
Ambient temperature	-10 °C ~40 °C

Panasonic Corporation

Web Site: <http://www.panasonic.com>

© Panasonic Corporation 2024

Issue date: 01/2024

P0124-0 SWGR14857