



Product information



Technical documents
Download from PRO CLUB

Panasonic®

Building Passion, Building Solutions. Panasonic Air Conditioning Systems

We face a time in which "quality air" differentiates business. It's a time for Panasonic to fully display its strengths. Our ability to assemble and build superior systems isn't just due to the rich resources we have as a comprehensive electronics manufacturer, but also to Panasonic's 100 years of tradition, where each person thinks and acts on their own initiative while working in a team to reach further heights. We do not compromise. Each of our independent selves is a one stop solution. We face our customers' challenges together with our customers and do all that we can to build effective systems. As a true partner for our customers, we strive to always be at the forefront of business.

- Please read the Installation Instructions carefully before installing the unit, and the Operating Instructions before using it.
- Specifications are subject to change without prior notice.
- The contents of this catalogue are accurate as of August 2023.
- Due to printing considerations, actual colours may vary slightly from those shown.
- All graphics are provided solely for the purpose of illustrating a point.



Do not add or replace refrigerant other than the specified type. Manufacturer is not responsible for damage or deterioration in safety due to usage of other refrigerant.

Authorised Dealer

FSV Mini FSV VIETNAM_AUGUST_2023

FSV VRF SYSTEMS 2023/2024



NEW ///

FSV EX

COOLING ONLY ///



FSV EX

HEAT PUMP ///



FSV EX

HEAT ///

RECOVERY ///



FSV

HEAT PUMP ///



nanoeX INVERTER

Panasonic Air-Conditioning Vietnam

(Ha Noi)

14th Floor, Charmvit Building,
117 Tran Duy Hung Street,
Trung Hoa Ward,
Cau Giay District, Hanoi.

(Da Nang)

16th Floor, Thanh Loi 2 Building,
1 Le Dinh Ly Street, Vinh Trung Ward,
Thanh Khe District, Danang City.

(Can Tho)

6th Floor, Xo So Kien Thiet Can Tho Building,
29 Cach Mang Thang Tam Street,
Thoi Binh Ward, Ninh Kieu District,
Can Tho City.

(Ho Chi Minh)

7th Floor, E-town 1 Building,
364 Cong Hoa Street, Ward 13,
Tan Binh District, Ho Chi Minh City.

Hotline: 1800 1593 / VRF Support Hotline: (+84) 902020300

QUALITY AIR FOR LIFE

FSV-EX Advantages



The most efficient, powerful and quiet system in Panasonic's history. There has never been a VRF system like it.

It's the story of a true game changer - Panasonic FSV-EX.

Extraordinary Energy-Saving Performance

The FSV-EX marks a revolutionary step forward in VRF efficiency. A look at the incredible EER value clearly indicates that. What's more, this high EER value is achieved even during part load operation.

This shows the extraordinary energy-saving performance the FSV-EX is capable of providing.

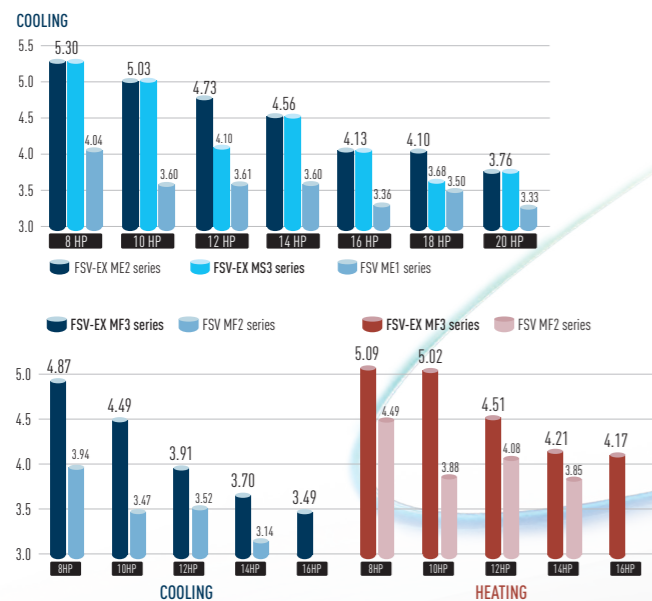

Extended Operation Range Up to 52°C

The FSV-EX can provide cooling even when the outside temperature reaches a maximum of about 52°C. And amazingly, it can still operate at 100% capacity when the outside temperature is as high as 43°C. This high power capability enables reliable operation even under extremely high temperature conditions.

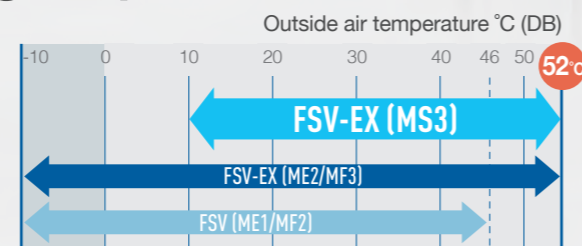

Low-Noise Operation

Numerous technological innovations, including an improved compressor and a newly designed bell mouth and larger fan, have dramatically reduced the outdoor noise level. The result is an even more comfortable building environment.

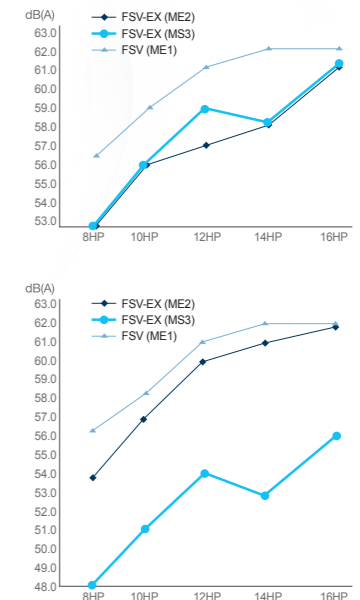

Multiple large-capacity all inverter twin rotary compressor

(multiple compressors for more than 14HP)

Two independently controlled inverter compressors achieve high efficiency. Redesigned components in the body provide performance improvement especially in the rated cooling condition and EER performance.

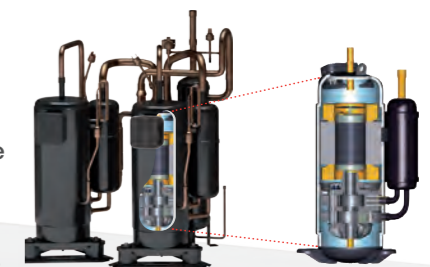

Enlarged heat exchanger surface area with triple surface*

The new heat exchanger features a triple-surface construction. Compared to the divided dual-surface construction in current models, there is no division of space and the area for heat exchange is larger. Also, highly efficient piping pattern increases heat exchange performance by 5%.*

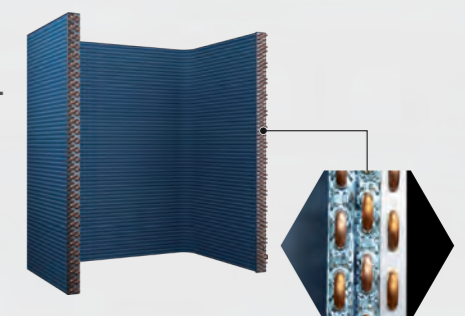

* For 8 and 10 HP of ME2, and 8, 10 and 12 HP of MS3, the heat exchanger is 2-row design.

Intelligent 3-stage Oil Management System



In a VRF system, where lengthy piping and a large number of indoor units need to be controlled collectively, the key to maintaining the system's reliability is to ensure an appropriate amount of oil is secured in the compressors. In order to avoid oil shortage in the compressor, maximum operation is normally forcibly conducted at regular intervals to recover oil from indoor units. This method, typically employed in a standard VRF, causes the system to overheat or overcool and thus waste energy.

In Panasonic FSV-EX systems, a sensor for detecting oil levels is mounted on the pipe of each compressor. In installations with multiple outdoor units, a shortage of oil in one compressor can be compensated for by recovering oil either from another compressor in the same unit, from a compressor in an adjacent outdoor unit, or from a connected indoor unit. Panasonic VRF systems provide users with a comfortable environment whilst saving energy.

The Panasonic system efficiently manages oil recovery in three stages; minimising the frequency of forced oil recovery while reducing energy cost and maintaining comfort.

STAGE-1

Panasonic compressors are equipped with sensors which monitor oil levels precisely at all times. If oil levels fall, oil can be transferred from other compressors within the same outdoor unit.



STAGE-2

If oil levels in all compressors within the outdoor unit fall, oil can be replenished from adjacent outdoor units.

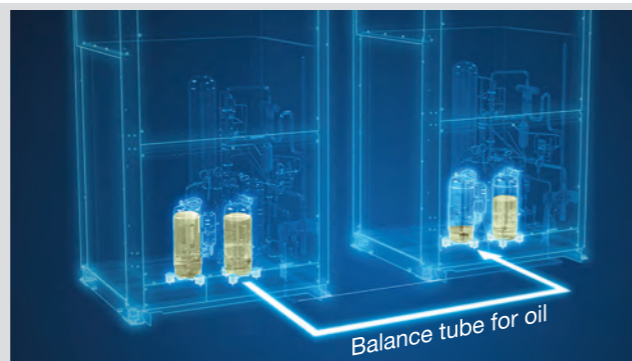

STAGE-3

Forced oil recovery is implemented only if oil levels become insufficient in spite of above measures. The Panasonic system's design concept is radically different from conventional oil systems.

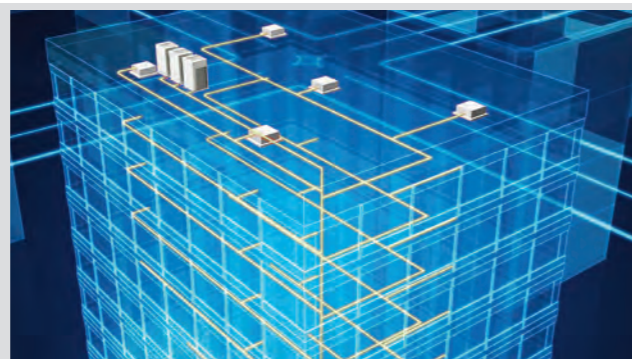

Features of 3-stage oil recovery design

1 Oil sensors mounted on each compressor

Oil sensors mounted on each Panasonic compressor precisely monitor oil levels, eliminating unnecessary oil recovery.



2 Highly functional oil separator

Thanks to extended separate piping, oil recovery efficiency reaches 90%, minimising the oil to be discharged from the compressor.

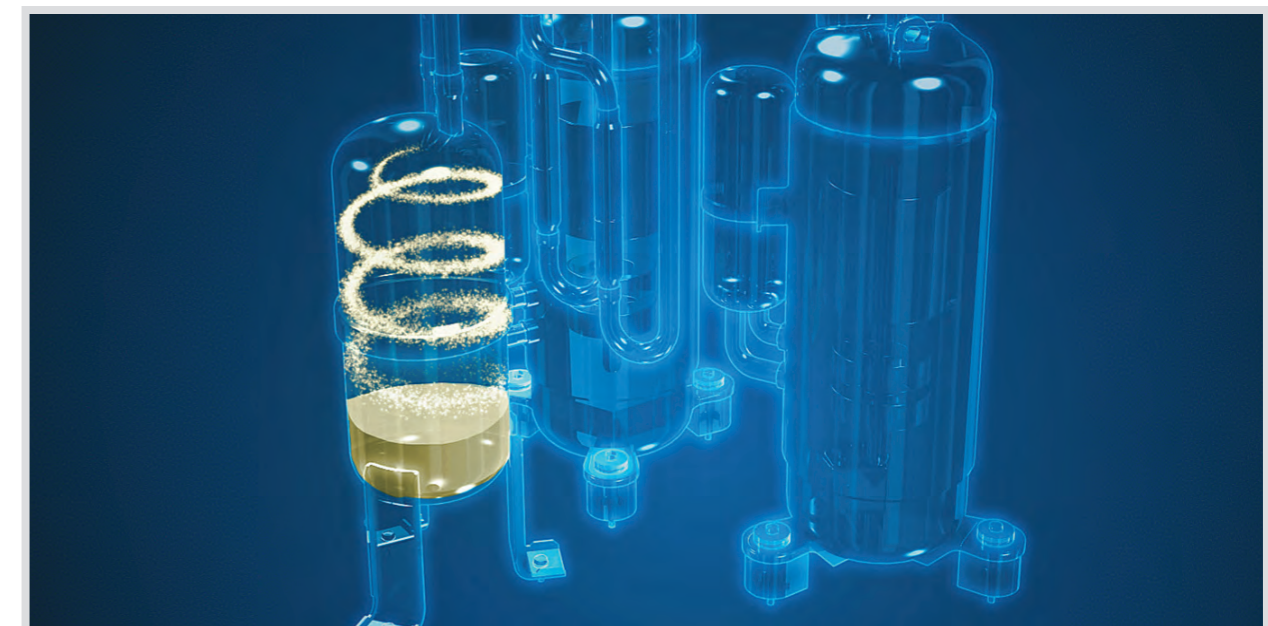

Panasonic VRF: Top In Comfort

Energy savings × Comfortable air conditioning ~Variable Evaporation Temperature (VET)~

Since 2006, all Panasonic VRF systems have included special VET technology, with variable refrigerant temperature, as standard. Our 'smart logic' system checks the temperature every 30 seconds, automatically adjusting the refrigerant temperature according to actual demand and outdoor conditions.

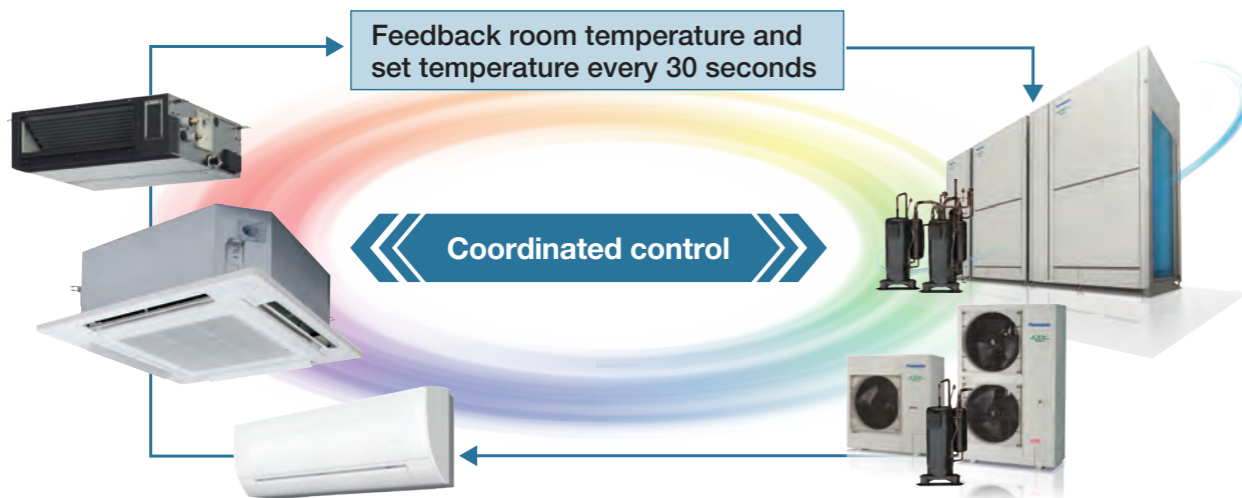

Calculate indoor refrigerant temperature and control the airflow automatically based on the difference between the setting temperature and actual indoor temperature.

Determine system refrigerant temperature and control compressor speed.

* When fan speed is Auto.

Achieves room-by-room comfort and overall system energy savings by controlling optimal refrigerant temperature and circulation volume based on all information of the entire system.

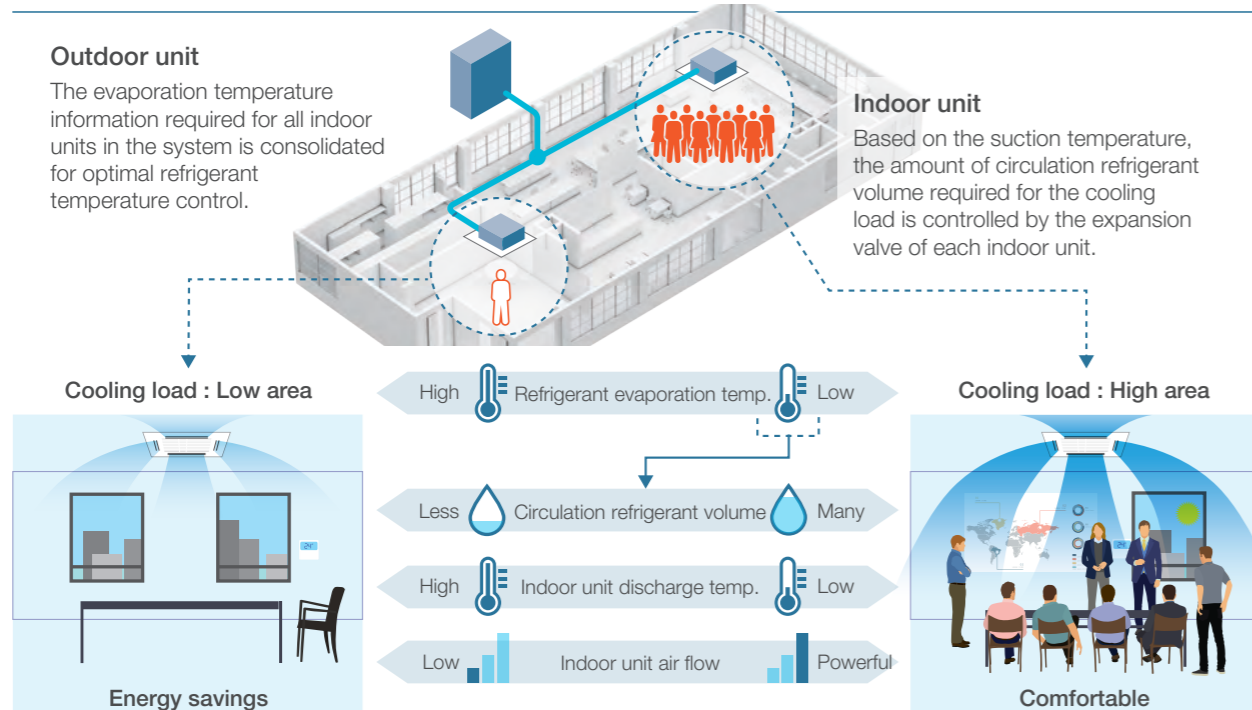

Combination of VET technology and inverter compressor achieves both energy savings and comfort by smoothly controlling the compressor to match the air conditioning load without stopping the compressor for optimum performance.

Image of room temperature change during cooling operation by scene.

1) Normal environment

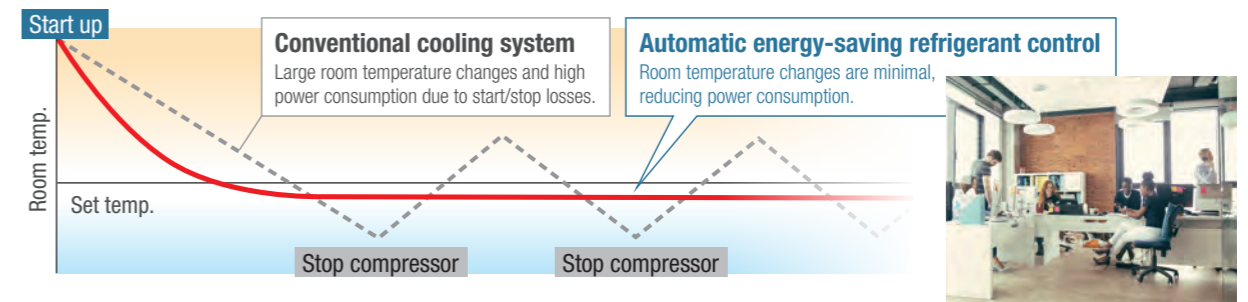

2) Environment with severe cooling load

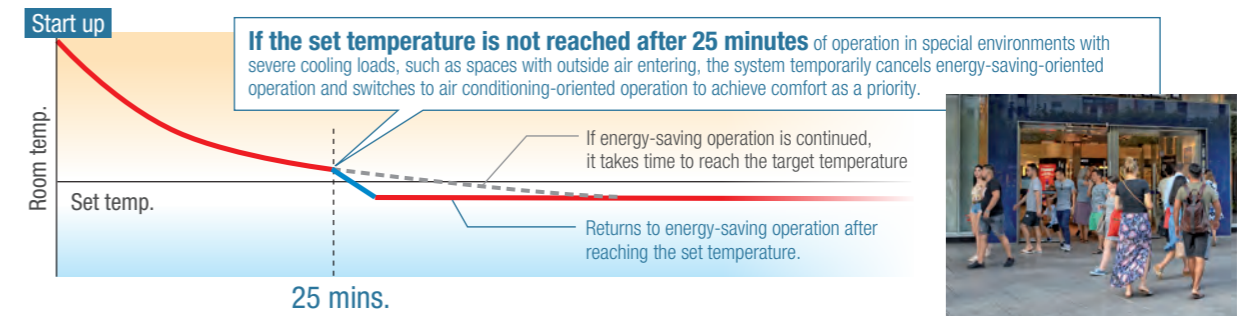

FSV-EX Advantages

Increased piping length for greater design flexibility

ME2 MS3

*1: 40 m if the outdoor unit is below the indoor unit. Elevation difference of Max. 90m in case of ODU is higher than IDU may be allowed following certain conditions.

*1, *2: Please consult with Panasonic sales engineers about the certain conditions in case of piping elevation of over 50m or level difference between indoor units over 15m is required.

MS3 series with exceeding 82HP does not support a height difference of 90m and a level difference of 30m.

Adaptable to various building types and sizes

Actual piping length : **200m**

(equivalent piping length : 210m)

Max. total piping length:1,000m

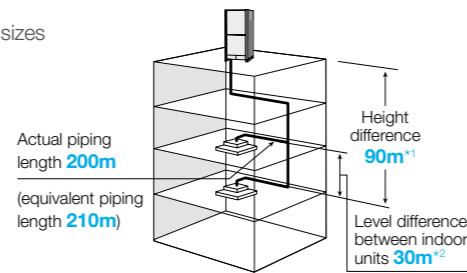

Connectable indoor/outdoor unit capacity ratio up to 130%*1

ME2 MS3

FSV systems attain maximum indoor unit connection capacity of up to 130 %*1 of the unit's connection range, depending on the outdoor and indoor models selected. So for a reasonable investment, FSV systems provide an ideal air conditioning solution for locations where full cooling/heating are not always required.

*1 82HP and above is equivalent to 80HP.

SYSTEM / HP	8	10	12	14	16	18	20	22	24	26	28	30	32	34	36	38	40	42	44	46	48	50	52	54	56	58	60	62	64	66	68	70	72	74	76	78	80	82	84	86	88	90	92	94	96	
SYSTEM / kW	22.4	28.0	33.5	40.0	45.0	50.0	56.0	61.5	68.0	73.0	78.5	85.0	90.0	96.0	101.0	107.0	113.0	118.0	124.0	130.0	135.0	140.0	145.0	151.0	156.0	162.0	168.0	174.0	180.0	185.0	190.0	196.0	202.0	208.0	213.0	219.0	224.0	230.0	240.0	240.0	240.0	250.0	260.0	270.0		
	ME2 SERIES																																													
	MS3 SERIES																																													
MNclU	13	16	19	23	26	29	33	36	40	43	46	50	53	56	59	63	64	64	64	64	64	64	64	64	64	64	64	64	64	64	64	64	64	64	64	64	64	64	64	64	64	64	64	64	64	64
No.1	28.1	36.4	43.6	52.0	58.5	65.0	72.8	80.0	88.4	94.9	102.1	110.5	117.0	124.8	131.3	138.1	146.9	153.4	161.2	169.0	175.5	182.0	188.5	196.3	202.8	210.6	218.4	226.2	234.0	240.5	247.0	254.8	262.6	270.4	278.9	284.7	291.2	291.2	291.2	291.2	291.2	291.2	291.2	291.2	291.2	
No.2	44.8	56.0	67.0	80.0	90.0	100.0	112.0	123.0	136.0	146.0	157.0	170.0	180.0	192.0	202.0	214.0	226.0	236.0	248.0	260.0	270.0	280.0	290.0	302.0	312.0	324.0	336.0	348.0	360.0	370.0	380.0	392.0	404.0	416.0	426.0	438.0	448.0	448.0	448.0	448.0	448.0	448.0	448.0	448.0	448.0	448.0

MNclU : Maximum Number of Connectable Indoor Unit

No.1 : Max connectable IDU capacity / kW (without condition) No.2 : Max connectable IDU capacity / kW (with below *2 condition)

Note: If more than 100% indoor units are operated with a high load, the units may not perform at the rated capacity. For the details, please consult with an authorised Panasonic dealer

*2 If the following conditions are satisfied, the effective range is "Max connectable IDU capacity / kW (with below *condition) figures" written in above No.2.

i) Obey the limited number of connectable indoor units.

ii) The lower limit of operating range for heating outdoor temperature is limited to -10°CWB (standard -25°CWB). (Only for ME2 series.)

iii) Simultaneous operation is limited to less than "Max connectable IDU capacity / kW (without condition) figures" written in above No.1.

Wide operating range

ME2 MS3

- Cooling operation is possible when outdoor temperature as low as -10°C DB
- Cooling operation is possible when outdoor temperature as high as 52°C DB
- Heating operation is possible when outdoor temperature as low as -25°C WB

The remote controller temperature can be set from 18°C up to 30°C (Cooling), 16°C up to 30°C (Heating)*.

* Depending on the type of remote controller.

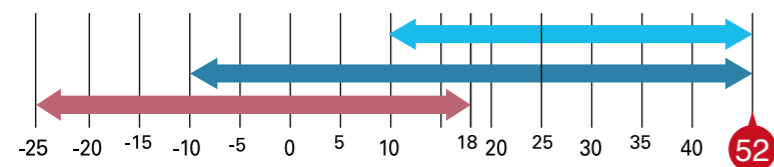

- Cooling: 10°C DB ~ 52°C DB (MS3)
- Cooling: -10°C DB ~ 52°C DB (ME2)
- Heating: -25°C WB ~ 18°C WB (ME2)

* For further information please refer to the capacity tables in the Technical Data Book.

High-durability outdoor unit

ME2

Corrosion-resistance treated for high resistance to rust and salty air to assure long-lasting performance.



Note: Selecting this unit does not completely eliminate the possibility of rust developing. For details concerning unit installation and maintenance, please consult an authorised dealer.

* Specific model with suffix "E" has this treatment.

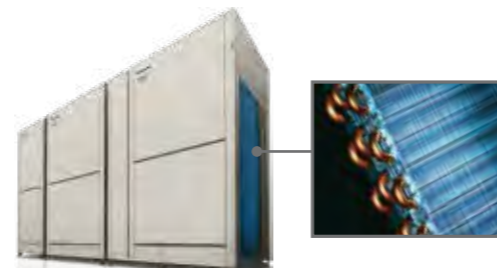

Prevents unit stoppages due to short circuits caused by geckos

ME2 MS3

One of the common causes of failures of the outdoor unit is electrical short circuits caused by geckos, small animals such as rats and insects entering the unit. The unit eliminates gaps that prevent geckos from entering the internal PCB and thus prevent operation stoppages.

Change Slit

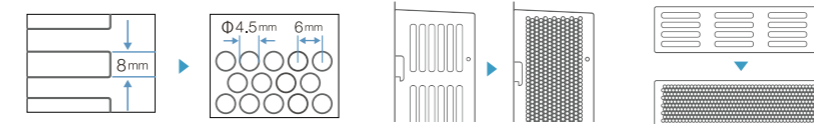

Excellent energy savings

ME2 MS3

The operation efficiency has been improved using highly efficient R410A refrigerant, new DC inverter compressor, and new heat exchanger design.

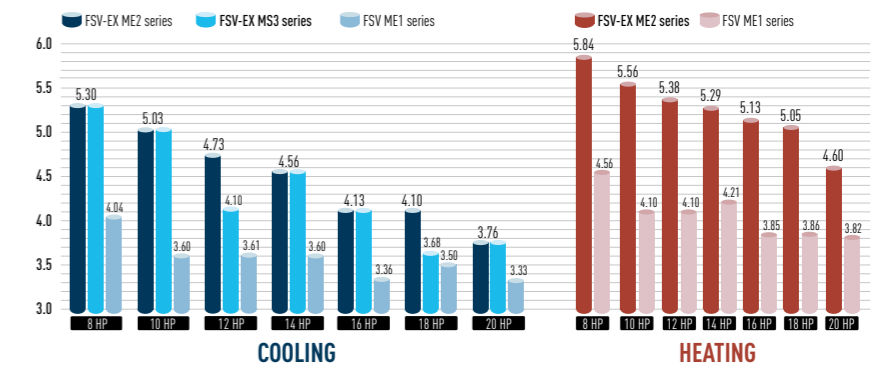

High external static pressure on condensers

ME2 MS3

With a newly designed fan, fan guard, motor, and casing, new models can be custom-installed on-site to provide up to 80 Pa of external static pressure. An air discharge duct prevents shortages of air circulation, allowing outdoor units to be installed on every floor of a building.



Fan

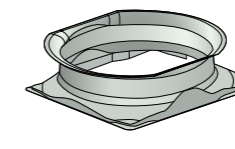

Fan Motor and Casing

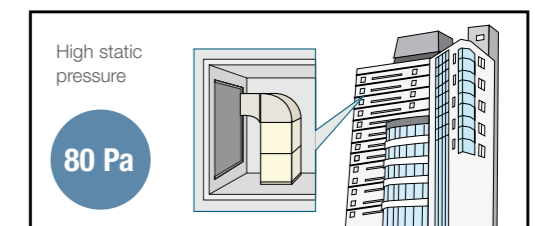

INDEX

2 FSV-EX Advantages	22 2-WAY FSV-EX ME2 Series	86 Panasonic Comfort Cloud
6 Panasonic VRF: Top In Comfort	26 3-WAY FSV-EX MF3 Series	88 VRF Smart Connectivity+
8 FSV-EX Advantages	34 2-WAY Mini-FSV LE Series	92 Panasonic AC Smart Cloud
10 Air Handling Unit Kit	40 nanoe™ X	94 FSV Controllers
12 CAC Design Support Software	44 CONEX	96 P-AIMS
14 FSV Systems	46 Indoor Units	100 Panasonic VRF Global Project References
16 FSV-EX MS3 Series	84 Smart Connectivity and Control Solutions	102 Panasonic Pro Club Global

Air Handling Unit Kit

AHU Kit connects FSV-EX and FSV outdoor units to Air Handling Units System



If you require this fresh air solution, please contact an authorized Panasonic distributor.

Connect Air Handling Unit to your FSV-EX and FSV systems for a high efficiency operation.

Application: Hotels, offices, server rooms or all large buildings where air quality control such as humidity control and fresh air are needed.

Project References

Office

Hong Kong
Red Cross Headquarters



Air Conditioning System:
VRF 2-way FSV ME1 series:
2 systems
Indoor Units: 2 units
AHU Kit: 6 units
Cooling Capacity: 280 kW / 80 USRT



Residential + Commercial

Malaysia Utropolis, Glenmarie



Air Conditioning System:
VRF 2-way FSV ME1 series:
29 systems
Indoor Units: 168 units
AHU Kit: 9 units
Cooling Capacity: 3,077 kW / 875 USRT



Air Handling Unit Kit to connect to your ventilation system

AHU Connection Kit

PCB, Power trans, Terminal block

Remote control can be easily installed on the AHU Kit box. (Remote control must be purchased separately.)

Expansion valve

Thermistor x2 (Refrigerant: E1, E3)

Thermistor x2 (Air: Tf, Tb)



Optional remote controller

High-spec Wired Remote Controller CZ-RTC5B



Timer remote controller. CZ-RTC4

Optional parts: Following functions are available by using different type of control accessories:

CZ-RTC4 Wired remote controller

- Operation-ON/OFF
- Mode select
- Temperature setting
- * Fan operation signal can be taken from the PCB.

T10 terminal

- Input signal= Operation ON/OFF

Remote controller prohibition

- Output signal= Operating-ON status
- Alarm output (by DC12 V)

OPTION terminal, DC12V outlet

- Output signal= Cool / Heat/Fan status
- Defrost
- Thermostat-ON

CZ-CAPBC2 Seri-para I/O unit for each indoor unit

- Temperature setting by 0-10 V or 0-140 Ω input signal
- Room (inlet air) temp outlet by 4-20 mA
- Mode select or/and ON/OFF control
- Fan operation control
- Operation status output/ Alarm output

Technical Zoom

- Max. piping length: 100m (actual)/ 120m (equivalent)
- Difference between longest and shortest piping from first branch: 10m
- Max. length of branch tubing: 12m
- * Other conditions to be referred the standard piping design regulations.
- Available temperature range in Heating: -20 °C (WB)-15 °C (WB)
- Available temperature range for the suction air at AHU Kit: Cool: 18-32 °C / Heat: 16-30 °C

CZ-280MAH1 // CZ-560MAH1

- The system controlled by the suction air (or return air from room) temperature as same as standard indoor unit. (Selectable mode: Automatic / Cooling / Heating / Fan / Dry (but same as Cool))
- The discharge air temperature is also controlled to prevent too-low air discharge in Cooling or too-high air discharge in Heating. (in case of VRF system)
- Demand control (Forcible thermostat-OFF control by operating current)

- Defrost operation signal, Thermo-ON/OFF states output
- External target temperature setting via Indoor/Outdoor signal interface is available with CZ-CAPBC2. (Ex. 0 - 10 V)
- Connectable with P-LINK system

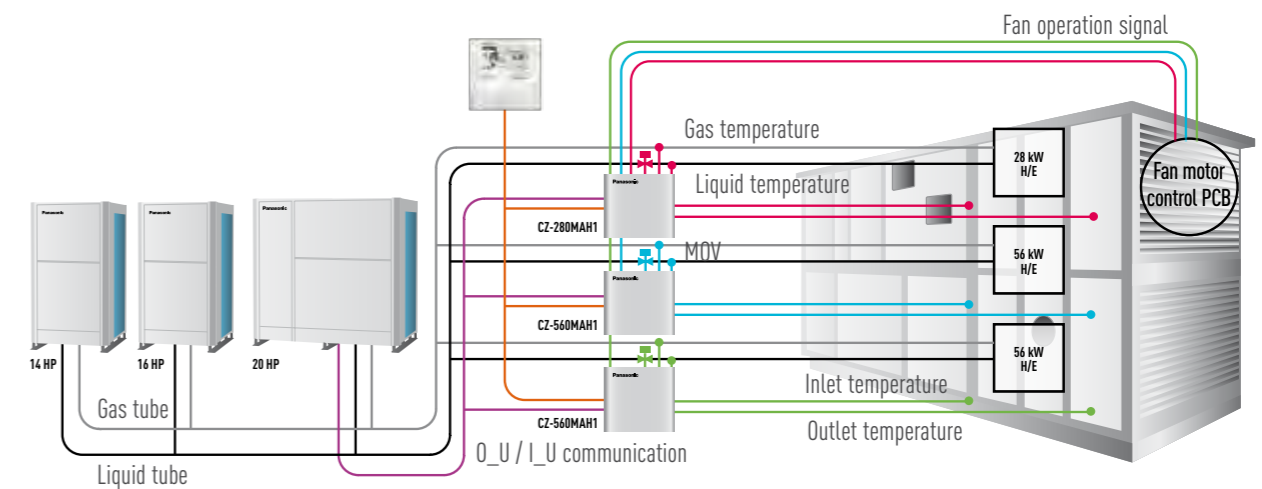

System and regulations. System overview

A: AHU Kit controller box (with control PCB)

B: AHU equipment (Field supplied)

C: Remote controller (option parts)

D: Outdoor unit

E: Gas piping (Field supplied)

F: Liquid piping (Field supplied)

G: Electronic expansion valve

H: Thermistor for gas pipe (E3)

I: Thermistor for liquid pipe (E1)

J: Thermistor for suction air (TA)

K: Thermistor for discharge air (BL)

L: Inter unit wiring

M: Magnetic relay for operating the blower (Field supplied)

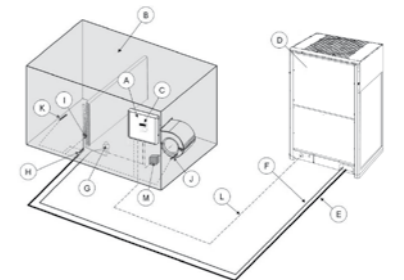

AHU Connection Kit / System Combination

	Capacity (HP)	Outdoor unit combination				AHU kit combination				
	28.0 kW (10 HP)	U-10MS3H7				CZ-280MAH1				
	56.0 kW (20 HP)	U-20MS3H7				CZ-560MAH1				
	85.0 kW (30 HP)	U-12MS3H7	U-18MS3H7			CZ-560MAH1	CZ-280MAH1			
	113.0 kW (40 HP)	U-16MS3H7	U-24MS3H7			CZ-560MAH1	CZ-560MAH1			
FSV-EX ME2/MS3 series (Space-saving Combination)	140.0 kW (50 HP)	U-8MS3H7	U-18MS3H7	U-24MS3H7		CZ-560MAH1	CZ-560MAH1	CZ-280MAH1		
	168.0 kW (60 HP)	U-12MS3H7	U-24MS3H7	U-24MS3H7		CZ-560MAH1	CZ-560MAH1	CZ-560MAH1		
	196.0 kW (70 HP)	U-22MS3H7	U-24MS3H7	U-24MS3H7	U-20ME2H7	CZ-560MAH1	CZ-560MAH1	CZ-560MAH1	CZ-280MAH1	
	224.0 kW (80 HP)	U-8MS3H7	U-24MS3H7	U-24MS3H7	U-24MS3H7	CZ-560MAH1	CZ-560MAH1	CZ-560MAH1	CZ-560MAH1	
	254.0 kW (90HP)	U-18MS3H7	U-24MS3H7	U-24MS3H7	U-24MS3H7	CZ-560MAH1	CZ-560MAH1	CZ-560MAH1	CZ-560MAH1	CZ-280MAH1

*These are preliminary. Please consult with Panasonic sales engineers.

CAC Design Support Software



Features the unique Drawing Capture Mode function providing More thorough spec-in and tender quotation support for easier, Faster completion of work.

Drawing Capture Mode Diagram

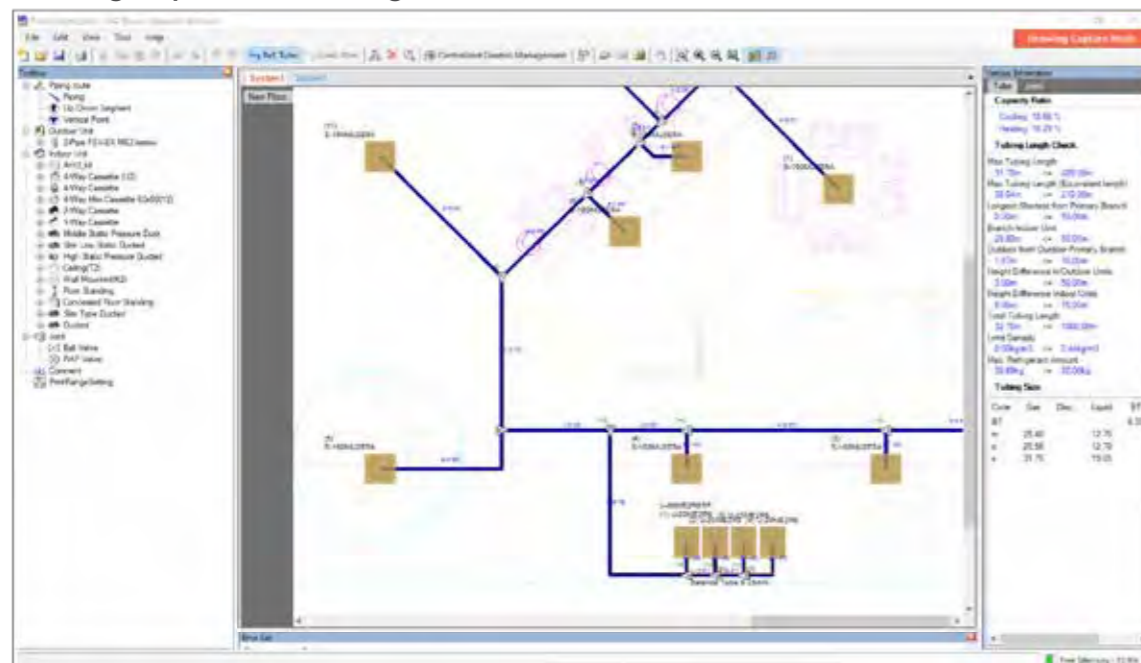

Schematic Mode Diagram

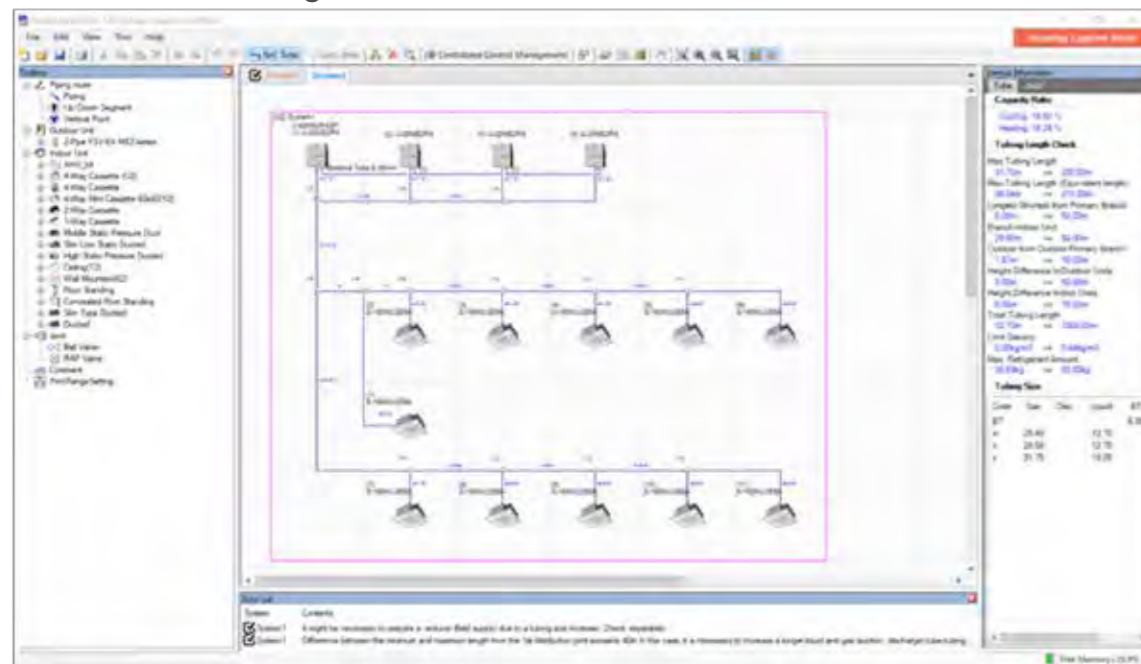

The Panasonic CAC Design Support software can be used for all Panasonic FSV

Panasonic has identified the importance of ever-increasing demands for fast and accurate responses to customer requests in our industry. More and more emphasis is being placed upon energy-efficiency in our marketplace. The ability to calculate cooling/heating loads and produce information of actual design conditions is a major advantage to any architect, consultant, contractor or end user. Panasonic understands the time-poor and demanding industry we are in and we are pleased to announce the launch of the next generation of our system design software program. The Panasonic CAC Design Support Software has been customized to make the selection and design process as quick and easy as possible. The design package utilizes system wizards and import tools to enable both simple and complex systems to be created. In addition, the system will allow outdoor and indoor units to be dragged on an interactive desktop. This allows users to create everything from realistic floor plans with detailed piping and wiring schematics to send out with quotations, through to installation guidance drawings.

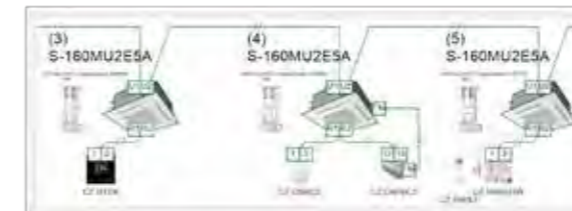

Order No.	Model Name	Brand	Capacity	Power	Flow Rate	Height	Weight	Volume	Material	Color	Remarks
01	S-160MU2E5A	Outdoor	16.0kW	12.5A	1.2m	100kg	0.15m³	1.0	Aluminum	White	Outdoor Unit
02	IC-01	Indoor	16.0kW	12.5A	1.2m	100kg	0.15m³	1.0	Aluminum	White	Indoor Unit
03	IC-02	Indoor	16.0kW	12.5A	1.2m	100kg	0.15m³	1.0	Aluminum	White	Indoor Unit
04	IC-03	Indoor	16.0kW	12.5A	1.2m	100kg	0.15m³	1.0	Aluminum	White	Indoor Unit
05	IC-04	Indoor	16.0kW	12.5A	1.2m	100kg	0.15m³	1.0	Aluminum	White	Indoor Unit
06	IC-05	Indoor	16.0kW	12.5A	1.2m	100kg	0.15m³	1.0	Aluminum	White	Indoor Unit
07	IC-06	Indoor	16.0kW	12.5A	1.2m	100kg	0.15m³	1.0	Aluminum	White	Indoor Unit
08	IC-07	Indoor	16.0kW	12.5A	1.2m	100kg	0.15m³	1.0	Aluminum	White	Indoor Unit
09	IC-08	Indoor	16.0kW	12.5A	1.2m	100kg	0.15m³	1.0	Aluminum	White	Indoor Unit

Features

- Drawing Capture mode
Design selection from building floor drawing.
- Any kind of drawing format. (.pdf, .dxf, .dwg, etc.)
- Conventional Schematic diagram.
- Easy to use system wizards.
- Converted duties for conditions and pipework.
- Auto(CAD) [.dxf/.dwg], Excel and PDF export.
- Detailed wiring and pipework diagrams with advising terminal number.

FSV Systems

FSV systems are designed for energy savings, high efficiency, and high durability with strong cooling power even operating at high ambient temperature. Panasonic continuously apply advanced technologies to meet the requirements of diverse situations and contribute to the creation of comfortable living spaces.



FSV-EX MS3 Series

Cooling-only model with space-saving system and high efficiency

Space-saving Combination Model

Cooling only Type

- Wide range of systems from 8HP to 96HP
- Class-leading EER of 5.3 (for 8HP model)
- Industry-leading low noise of 53.0 DB (8HP model)
- Cooling operation possible with outdoor temperature as high as 52°C (DB)
- Long maximum pipe length (up to 1,000 m)
- Up to 64 indoor units connectable
- External static pressure of 80 Pa

High Efficiency Combination Model

Cooling only Type

- Wide range of systems from 8HP to 64HP
- Class-leading EER of 5.3 (for 8HP model)
- Higher EER than the Space-saving Combination Model
e.g., a combination of two 10HP units delivering 20HP reduces compressor load.



NEW



MS3 series movie

3-WAY FSV-EX MF3 Series

For simultaneous heating and cooling operation

Cooling and Heating Simultaneous Type

- Wide range of systems from 8HP to 48HP
- Top class EER : 4.87 / COP : 5.09 (in the case of 8HP)
- Longer max piping length (up to 500 m)
- Increased max number of connectable indoor units (up to 52)
- External static pressure up to 80Pa
- Cooling operation is possible when outdoor temperature as high as 52°C DB
- Operating range to provide heating at outdoor temperature as low as -20°C WB
- Suitable for R22 renewal projects



Heat Recovery Type

2-WAY FSV-EX ME2 Series

Extraordinary energy-saving performance and powerful operation

Space-saving Combination Model

Cooling or Heating Type High-Durability Model

- Wide range of systems from 8HP to 80HP
- Class-leading EER of 5.3 (for 8HP model)
- Industry-leading low noise of 53.0 DB (8HP model)
- Cooling operation possible with outdoor temperature as high as 52°C (DB)
- Long maximum pipe length (up to 1,000 m)
- Up to 64 indoor units connectable
- External static pressure of 80 Pa
- Extended operating range allows heating with outdoor temperatures as low as -25°C (WB)

High Efficiency Combination Model

Cooling or Heating Type High-Durability Model

- Wide range of systems from 8HP to 64HP
- Class-leading EER of 5.3 (for 8HP model)
- Higher EER than the Space-saving Combination Model
e.g., a combination of two 10HP units delivering 20HP reduces compressor load.



2-WAY Mini-FSV LE Series

For small-scale commercial and residential use

Cooling or Heating Type 1-phase
Cooling or Heating Type 3-phase

High-Durability Model

4/5/6 HP 8/10 HP

- High external static pressure 35Pa
- Top-class EER: 5.08 (In case of 4HP) / 4.20 (In case of 8HP)
- Wide operation range: Cooling: -10°C to 46°C DB, Heating at: -20°C to 18°C DB
- Maximum number of connectable indoor units : 13 (In case of 8/10HP)
- Actual piping length : 150m
Max. piping length : 150m (4/5/6HP) / 300m (8/10HP)
- Suitable for R22 renewal projects



LE2

LE1

Industry Top Class EER/COP

Cooling Only FSV-EX MS3 Series **HIGH EFFICIENCY COMBINATION MODEL**

Appearance																			
HP	8	10	12	14	16	18	20	22	24										
Model name	U-8MS3H7	U-10MS3H7	U-12MS3H7	U-14MS3H7	U-16MS3H7	U-18MS3H7E U-10MS3H7	U-20MS3H7E U-10MS3H7	U-22MS3H7E U-12MS3H7	U-24MS3H7E U-12MS3H7										
Power supply	380/400/415V/3-phase/50Hz 380/400V/3-phase/60Hz																		
Capacity	Cooling	kW	22.4	28.0	33.5	40.0	45.0	50.0	56.0	61.5	68.0								
		BTU/h	76,500	95,600	114,300	136,500	153,600	170,600	191,100	209,900	232,100								
EER / COP	Cooling	W/W	5.30	5.03	4.10	4.56	4.13	5.15	5.05	4.49	4.07								
Dimensions	H x W x D	mm	1,842 x 770 x 1,000	1,842 x 770 x 1,000	1,842 x 770 x 1,000	1,842 x 1,180 x 1,000	1,842 x 1,180 x 1,000	1,842 x 1,600 x 1,000	1,842 x 1,600 x 1,000	1,842 x 1,600 x 1,000	1,842 x 1,600 x 1,000								
Net weight		kg	210	210	210	313	313	420	420	420	420								
Electrical ratings	Cooling	Running current	A	7.14 / 6.78 / 6.54	9.62 / 9.14 / 8.81	13.6 / 13.0 / 12.5	15.3 / 14.5 / 14.0	18.4 / 17.5 / 16.8	16.6 / 15.7 / 15.2	19.2 / 18.2 / 17.5	23.1 / 22.0 / 21.2	27.9 / 26.5 / 25.5							
		Power input	kW	4.23	5.57	8.17	8.77	10.9	9.70	11.1	13.7	16.7							
Starting current		A	1	1	1	2	2	2	2	2	2								
Air flow rate		m³/h	13,440	13,440	13,440	13,920	13,920	26,880	26,880	26,880	26,880								
		L/s	3,733	3,733	3,733	3,867	3,867	7,467	7,467	7,467	7,467								
Refrigerant amount at shipment		kg	5.6	5.6	5.6	8.3	8.3	11.2	11.2	11.2	11.2								
External static pressure		Pa	80	80	80	80	80	80	80	80	80								
Piping connections	Gas pipe	mm (inches)	Ø19.05 (Ø3/4)	Ø22.22 (Ø7/8)	Ø28.58 (Ø1-1/8)	Ø28.58 (Ø1-1/8)	Ø28.58 (Ø1-1/8)	Ø28.58 (Ø1-1/8)	Ø28.58 (Ø1-1/8)	Ø28.58 (Ø1-1/8)	Ø28.58 (Ø1-1/8)								
	Liquid pipe	mm (inches)	Ø9.52 (Ø3/8)	Ø9.52 (Ø3/8)	Ø12.70 (Ø1/2)	Ø12.70 (Ø1/2)	Ø12.70 (Ø1/2)	Ø12.70 (Ø1/2)	Ø15.88 (Ø5/8)	Ø15.88 (Ø5/8)	Ø15.88 (Ø5/8)								
	Balance pipe	mm (inches)	Ø6.35 (Ø1/4)	Ø6.35 (Ø1/4)	Ø6.35 (Ø1/4)	Ø6.35 (Ø1/4)	Ø6.35 (Ø1/4)	Ø6.35 (Ø1/4)	Ø6.35 (Ø1/4)	Ø6.35 (Ø1/4)	Ø6.35 (Ø1/4)								
Ambient temperature operating range			Cooling: 10°C (DB)~ +52°C (DB)																
Sound pressure level	Normal mode	dB (A)	53.0	56.0	59.0	58.0	61.0	58.0	59.0	61.0	62.0								
	Silent mode (2)	dB (A)	48.0	51.0	54.0	53.0	56.0	53.0	54.0	56.0	57.0								
Sound power level	Normal mode	dB	74.0	77.0	80.0	79.0	82.0	79.0	80.0	82.0	83.0								

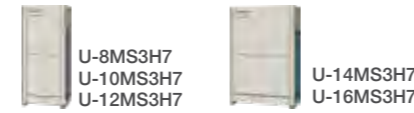

HP		26	28	30	32	34	36	38	40	42	44	46	48	50	52														
Model name		U-26MS3H7E U-10MS3H7 U-16MS3H7	U-28MS3H7E U-12MS3H7 U-16MS3H7	U-30MS3H7E U-14MS3H7 U-16MS3H7	U-32MS3H7E U-16MS3H7	U-34MS3H7E U-10MS3H7 U-12MS3H7	U-36MS3H7E U-12MS3H7 U-12MS3H7	U-38MS3H7E U-10MS3H7 U-12MS3H7	U-40MS3H7E U-12MS3H7 U-16MS3H7	U-42MS3H7E U-10MS3H7 U-16MS3H7	U-44MS3H7E U-12MS3H7 U-16MS3H7	U-46MS3H7E U-14MS3H7 U-16MS3H7	U-48MS3H7E U-16MS3H7 U-16MS3H7	U-50MS3H7E U-10MS3H7 U-12MS3H7 U-12MS3H7	U-52MS3H7E U-12MS3H7 U-12MS3H7 U-16MS3H7														
Power supply		380/400/415V/3-phase/50Hz 380/400V/3-phase/60Hz																											
Capacity	Cooling	kW	73.0	78.5	85.0	90.0	96.0	101.0	107.0	113.0	118.0	124.0	130.0	135.0	140.0	145.0													
		BTU/h	249,100	267,900	290,100	307,200	327,600	344,700	365,200	385,700	402,700	423,200	443,700	460,800	477,800	494,900													
EER / COP	Cooling	W/W	4.42	4.11	4.31	4.13	4.30	4.09	4.31	4.09	4.31	4.11	4.25	4.13	4.27	4.12													
Dimensions	H x W x D	mm	1,842 x 2,010 x 1,000	1,842 x 2,010 x 1,000	1,842 x 2,420 x 1,000	1,842 x 2,420 x 1,000	1,842 x 2,430 x 1,000	1,842 x 2,430 x 1,000	1,842 x 2,840 x 1,000	1,842 x 2,840 x 1,000	1,842 x 3,250 x 1,000	1,842 x 3,250 x 1,000	1,842 x 3,660 x 1,000	1,842 x 3,660 x 1,000	1,842 x 3,670 x 1,000	1,842 x 3,670 x 1,000													
Net weight		kg	523	523	626	626	630	630	733	733	836	836	939	939	943	943													
Electrical ratings	Cooling	Running current	A	28.2 / 26.8 / 25.8	32.2 / 30.6 / 29.5	33.6 / 31.9 / 30.8	36.8 / 35.0 / 33.7	37.6 / 35.8 / 34.5	41.2 / 39.2 / 37.8	41.9 / 39.8 / 38.3	46.1 / 43.8 / 42.2	46.3 / 43.9 / 42.4	51.0 / 48.4 / 46.7	52.2 / 49.6 / 47.8	55.2 / 52.4 / 50.5	55.4 / 52.6 / 50.7	58.8 / 55.8 / 53.8												
		Power input	kW	16.5	19.1	19.7	21.8	22.3	24.7	24.8	27.6	27.4	30.2	30.6	32.7	32.8	35.2												
Starting current		A	3	3	4	4	3	3	4	4	5	5	6	6	5	5													
Air flow rate		m³/h	27,360	27,360	27,840	27,840	40,320	40,320	40,800	40,800	41,280	41,280	41,760	41,760	54,240	54,240													
		L/s	7,600	7,600	7,733	7,733	11,200	11,200	11,333	11,333	11,467	11,467	11,600	11,600	15,067	15,067													
Refrigerant amount at shipment		kg	13.9	13.9	16.6	16.6	16.8	16.8	19.5	19.5	22.2	22.2	24.9	24.9	25.1	25.1													
External static pressure		Pa	80	80	80	80	80	80	80	80	80	80	80	80	80	80													
Piping connections	Gas pipe	mm (inches)	Ø34.92 (Ø1-3/8)	Ø34.92 (Ø1-3/8)	Ø34.92 (Ø1-3/8)	Ø34.92 (Ø1-3/8)	Ø34.92 (Ø1-3/8)	Ø34.92 (Ø1-3/8)	Ø41.28 (Ø1-5/8)	Ø41.28 (Ø1-5/8)	Ø41.28 (Ø1-5/8)	Ø41.28 (Ø1-5/8)	Ø41.28 (Ø1-5/8)	Ø41.28 (Ø1-5/8)	Ø41.28 (Ø1-5/8)	Ø41.28 (Ø1-5/8)													
	Liquid pipe	mm (inches)	Ø19.05 (Ø3/4)	Ø19.05 (Ø3/4)	Ø19.05 (Ø3/4)	Ø19.05 (Ø3/4)	Ø19.05 (Ø3/4)	Ø19.05 (Ø3/4)	Ø19.05 (Ø3/4)	Ø19.05 (Ø3/4)	Ø19.05 (Ø3/4)	Ø19.05 (Ø3/4)	Ø19.05 (Ø3/4)	Ø19.05 (Ø3/4)	Ø19.05 (Ø3/4)	Ø19.05 (Ø3/4)													
	Balance pipe	mm (inches)	Ø6.35 (Ø1/4)	Ø6.35 (Ø1/4)	Ø6.35 (Ø1/4)	Ø6.35 (Ø1/4)	Ø6.35 (Ø1/4)	Ø6.35 (Ø1/4)	Ø6.35 (Ø1/4)	Ø6.35 (Ø1/4)	Ø6.35 (Ø1/4)	Ø6.35 (Ø1/4)	Ø6.35 (Ø1/4)	Ø6.35 (Ø1/4)	Ø6.35 (Ø1/4)	Ø6.35 (Ø1/4)													
Ambient temperature operating range			Cooling: 10°C (DB)~ +52°C (DB)																										
Sound pressure level	Normal mode	dB (A)	62.0	63.0	63.0	64.0	63.0	64.0	65.0	65.0	66.0	65.0	66.0	65.0	66.0	65.0													
	Silent mode (2)	dB (A)	57.0	58.0	58.0	59.0	58.0	59.0	59.0	60.0	60.0	60.0	60.0	61.0	60.0	61.0													
Sound power level	Normal mode	dB	83.0	84.0	84.0	85.0	84.0	85.0	85.0	86.0	86.0	86.0	86.0	87.0	86.0	87.0													

Appearance												
HP	54	56	58	60	62	64						
Model name	U-54MS3H7E U-10MS3H7 U-12MS3H7 U-16MS3H7 U-16MS3H7	U-56MS3H7E U-12MS3H7 U-12MS3H7 U-16MS3H7 U-16MS3H7	U-58MS3H7E U-10MS3H7 U-16MS3H7 U-16MS3H7 U-16MS3H7	U-60MS3H7E U-12MS3H7 U-16MS3H7 U-16MS3H7 U-16MS3H7	U-62MS3H7E U-14MS3H7 U-16MS3H7 U-16MS3H7 U-16MS3H7	U-64MS3H7E U-16MS3H7 U-16MS3H7 U-16MS3H7 U-16MS3H7						
Power supply	380/400/415V/3-phase/50Hz 380/400V/3-phase/60Hz											
Capacity	Cooling	kW	151.0	156.0	162.0	168.0	174.0	180.0				
		BTU/h	515,400	532,400	552,900	573,400	593,900	614,300				
EER / COP	Cooling	W/W	4.27	4.13	4.27	4.13	4.23	4.13				
Dimensions	H x W x D	mm	1,842 x 4,080 x 1,000	1,842 x 4,080 x 1,000	1,842 x 4,490 x 1,000	1,842 x 4,490 x 1,000	1,842 x 4,900 x 1,000	1,842 x 4,900 x 1,000				
Net weight		kg	1,046	1,046	1,149	1,149	1,252	1,252				
Electrical ratings	Cooling	Running current	A	59.8 / 56.8 / 54.7	63.8 / 60.6 / 58.4	64.0 / 60.8 / 58.6	68.7 / 65.3 / 62.9	70.2 / 66.7 / 64.2	73.6 / 69.9 / 67.4			
		Power input	kW	35.4	37.8	37.9	40.7	41.1	43.6			
Starting current		A	6	6	7	7	8	8				
Air flow rate		m³/h	54,720	54,720	55,200	55,200	55,680	55,680				
		L/s	15,200	15,200	15,333	15,333	15,467	15,467				
Refrigerant amount at shipment		kg	27.8	27.8	30.5	30.5	33.2	33.2				
External static pressure		Pa	80	80	80	80	80	80				
Piping connections	Gas pipe	mm (inches)	Ø41.28 (Ø1-5/8)	Ø41.28 (Ø1-5/8)	Ø41.28 (Ø1-5/8)	Ø41.28 (Ø1-5/8)	Ø41.28 (Ø1-5/8)	Ø41.28 (Ø1-5/8)				
	Liquid pipe	mm (inches)	Ø19.05 (Ø3/4)	Ø19.05 (Ø3/4)	Ø19.05 (Ø3/4)	Ø19.05 (Ø3/4)	Ø19.05 (Ø3/4)	Ø19.05 (Ø3/4)				
	Balance pipe	mm (inches)	Ø6.35 (Ø1/4)	Ø6.35 (Ø1/4)	Ø6.35 (Ø1/4)	Ø6.35 (Ø1/4)	Ø6.35 (Ø1/4)	Ø6.35 (Ø1/4)				
Ambient temperature operating range			Cooling: 10°C (DB)~ +52°C (DB)									
Sound pressure level	Normal mode	dB (A)	66.0	66.0	66.0	67.0	66.0	67.0				
	Silent mode (2)	dB (A)	61.0	61.0	61.0	62.0	61.0	62.0				
Sound power level	Normal mode	dB	87.0	87.0	87.0	88.0	87.0	88.0				

GLOBALREMARKS

Rated conditions:	Cooling
Indoor air temperature	27°C DB / 19°C WB
Outdoor air temperature	35°C DB

These specifications are subject to change without notice.

8 / 10 / 12 HP

According to the installation site, you may choose the setting position in the depth direction of the anchor bolt from A, B or C.

- A: (Installation hole pitch) For removing tube forward
- B: (Installation hole pitch) For removing the downward
- C: (Installation hole pitch)

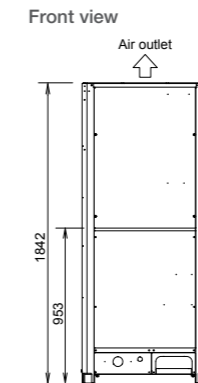
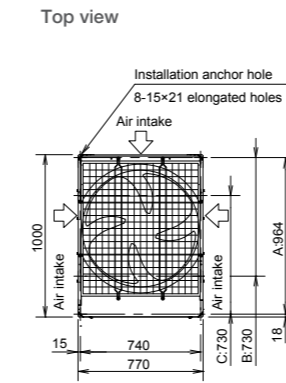

unit: mm

14 / 16 HP

According to the installation site, you may choose the setting position in the depth direction of the anchor bolt from A, B or C.

- A: (Installation hole pitch) For removing tube forward
- B: (Installation hole pitch) For removing the downward
- C: (Installation hole pitch)

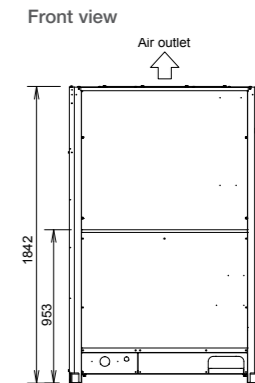
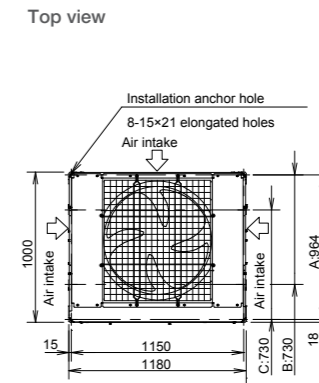

unit: mm

Cooling Only FSV-EX MS3 Series

SPACE SAVING COMBINATION MODEL

Appearance											
HP		8	10	12	14	16	18	20	22	24	
Model name		U-8MS3H7 U-10MS3H7 U-12MS3H7	U-10MS3H7 U-18MS3H7 U-24MS3H7	U-12MS3H7 U-18MS3H7 U-24MS3H7	U-14MS3H7 U-16MS3H7 U-18MS3H7	U-16MS3H7 U-18MS3H7 U-24MS3H7	U-18MS3H7 U-20MS3H7 U-24MS3H7	U-20MS3H7 U-22MS3H7 U-24MS3H7	U-22MS3H7 U-24MS3H7	U-24MS3H7	
Power supply		380/400/415V/3-phase/50Hz 380/400V/3-phase/60Hz									
Capacity	Cooling	kW	22.4	28.0	33.5	40.0	45.0	50.0	56.0	61.5	68.0
		BTU/h	76,500	95,600	114,300	136,500	153,600	170,600	191,100	209,900	232,100
EER / COP	Cooling	W/W	5.30	5.03	4.10	4.56	4.13	3.68	3.76	3.60	3.42
Dimensions	H x W x D	mm	1,842 x 770 x 1,000	1,842 x 770 x 1,000	1,842 x 770 x 1,000	1,842 x 1,180 x 1,000	1,842 x 1,180 x 1,000	1,842 x 1,180 x 1,000	1,842 x 1,540 x 1,000	1,842 x 1,540 x 1,000	1,842 x 1,540 x 1,000
		kg	210	210	210	313	313	313	366	366	366
Electrical ratings	Cooling	Running current	A	7.14 / 6.78 / 6.54	9.62 / 9.14 / 8.81	13.6 / 13.0 / 12.5	15.3 / 14.5 / 14.0	18.4 / 17.5 / 16.8	23.0 / 21.8 / 21.0	24.6 / 23.4 / 22.5	28.2 / 26.8 / 25.9
		Power input	kW	4.23	5.57	8.17	8.77	10.9	13.6	14.9	17.1
Starting current		A	1	1	1	2	2	2	2	2	
Air flow rate		m³/h	13,440	13,440	13,440	13,920	13,920	13,920	24,300	24,300	24,300
		L/s	3,733	3,733	3,733	3,867	3,867	3,867	6,750	6,750	6,750
Refrigerant amount at shipment		kg	5.6	5.6	5.6	8.3	8.3	8.3	9.5	9.5	9.5
External static pressure		Pa	80	80	80	80	80	80	80	80	
Piping connections	Gas pipe	mm (inches)	Ø19.05 (Ø3/4)	Ø22.22 (Ø7/8)	Ø28.58 (Ø1-1/8)	Ø28.58 (Ø1-1/8)	Ø28.58 (Ø1-1/8)	Ø28.58 (Ø1-1/8)	Ø28.58 (Ø1-1/8)	Ø28.58 (Ø1-1/8)	Ø28.58 (Ø1-1/8)
	Liquid pipe	mm (inches)	Ø9.52 (Ø3/8)	Ø9.52 (Ø3/8)	Ø12.70 (Ø1/2)	Ø12.70 (Ø1/2)	Ø12.70 (Ø1/2)	Ø15.88 (Ø5/8)	Ø15.88 (Ø5/8)	Ø15.88 (Ø5/8)	Ø15.88 (Ø5/8)
	Balance pipe	mm (inches)	Ø6.35 (Ø1/4)	Ø6.35 (Ø1/4)	Ø6.35 (Ø1/4)	Ø6.35 (Ø1/4)	Ø6.35 (Ø1/4)	Ø6.35 (Ø1/4)	Ø6.35 (Ø1/4)	Ø6.35 (Ø1/4)	Ø6.35 (Ø1/4)
Ambient temperature operating range			Cooling: 10°C (DB)~ +52°C (DB)								
Sound pressure level	Normal mode	dB (A)	53.0	56.0	59.0	58.0	61.0	62.0	59.0	62.0	62.0
	Silent mode (2)	dB (A)	48.0	51.0	54.0	53.0	56.0	57.0	54.0	57.0	57.0
Sound power level	Normal mode	dB	74.0	77.0	80.0	79.0	82.0	83.0	80.0	83.0	83.0

Appearance														
HP		26	28	30	32	34	36	38	40	42	44	46	48	
Model name		U-26MS3H7SP U-8MS3H7 U-10MS3H7 U-12MS3H7	U-28MS3H7SP U-10MS3H7 U-18MS3H7	U-30MS3H7SP U-12MS3H7 U-18MS3H7	U-32MS3H7SP U-8MS3H7 U-24MS3H7	U-34MS3H7SP U-10MS3H7 U-24MS3H7	U-36MS3H7SP U-12MS3H7 U-24MS3H7	U-38MS3H7SP U-14MS3H7 U-24MS3H7	U-40MS3H7SP U-16MS3H7 U-24MS3H7	U-42MS3H7SP U-18MS3H7 U-24MS3H7	U-44MS3H7SP U-20MS3H7 U-24MS3H7	U-46MS3H7SP U-22MS3H7 U-24MS3H7	U-48MS3H7SP U-24MS3H7	
Power supply		380/400/415V/3-phase/50Hz 380/400V/3-phase/60Hz												
Capacity	Cooling	kW	73.0	78.5	85.0	90.0	96.0	101.0	107.0	113.0	118.0	124.0	130.0	135.0
		BTU/h	249,100	267,900	290,100	307,200	327,600	344,700	365,200	385,700	402,700	423,200	443,700	460,800
EER / COP	Cooling	W/W	4.03	4.05	3.79	3.75	3.76	3.63	3.78	3.67	3.52	3.56	3.49	3.44
Dimensions	H x W x D	mm	1,842 x 2,010 x 1,000	1,842 x 2,010 x 1,000	1,842 x 2,010 x 1,000	1,842 x 2,370 x 1,000	1,842 x 2,370 x 1,000	1,842 x 2,370 x 1,000	1,842 x 2,780 x 1,000	1,842 x 2,780 x 1,000	1,842 x 2,780 x 1,000	1,842 x 2,780 x 1,000	1,842 x 3,140 x 1,000	1,842 x 3,140 x 1,000
		kg	523	523	523	576	576	576	679	679	679	732	732	732
Electrical ratings	Cooling	Running current	A	30.6 / 29.0 / 28.0	33.1 / 31.5 / 30.3	37.8 / 35.9 / 34.6	39.6 / 37.7 / 36.3	42.6 / 40.4 / 39.0	45.9 / 43.6 / 42.0	47.8 / 45.4 / 43.7	51.4 / 48.9 / 47.1	55.9 / 53.1 / 51.2	57.5 / 54.6 / 52.6	61.4 / 58.4 / 56.3
		Power input	kW	18.1	19.4	22.4	24.0	25.5	27.8	28.3	30.8	33.5	34.8	37.2
Starting current		A	3	3	3	3	3	3	4	4	4	4	4	
Air flow rate		m³/h	27,360	27,360	27,360	37,740	37,740	37,740	38,220	38,220	38,220	48,600	48,600	48,600
		L/s	7,600	7,600	7,600	10,483	10,483	10,483	10,617	10,617	10,617	13,500	13,500	13,500
Refrigerant amount at shipment		kg	13.9	13.9	13.9	15.1	15.1	15.1	17.8	17.8	17.8	19.0	19.0	19.0
External static pressure		Pa	80	80	80	80	80	80	80	80	80	80	80	
Piping connections	Gas pipe	mm (inches)	Ø34.92 (Ø1-3/8)	Ø34.92 (Ø1-3/8)	Ø34.92 (Ø1-3/8)	Ø34.92 (Ø1-3/8)	Ø34.92 (Ø1-3/8)	Ø41.28 (Ø1-5/8)	Ø41.28 (Ø1-5/8)	Ø41.28 (Ø1-5/8)	Ø41.28 (Ø1-5/8)	Ø41.28 (Ø1-5/8)	Ø41.28 (Ø1-5/8)	Ø41.28 (Ø1-5/8)
	Liquid pipe	mm (inches)	Ø19.05 (Ø3/4)	Ø19.05 (Ø3/4)	Ø19.05 (Ø3/4)	Ø19.05 (Ø3/4)	Ø19.05 (Ø3/4)	Ø19.05 (Ø3/4)	Ø19.05 (Ø3/4)	Ø19.05 (Ø3/4)	Ø19.05 (Ø3/4)	Ø19.05 (Ø3/4)	Ø19.05 (Ø3/4)	Ø19.05 (Ø3/4)
	Balance pipe	mm (inches)	Ø6.35 (Ø1/4)	Ø6.35 (Ø1/4)	Ø6.35 (Ø1/4)	Ø6.35 (Ø1/4)	Ø6.35 (Ø1/4)	Ø6.35 (Ø1/4)	Ø6.35 (Ø1/4)	Ø6.35 (Ø1/4)	Ø6.35 (Ø1/4)	Ø6.35 (Ø1/4)	Ø6.35 (Ø1/4)	Ø6.35 (Ø1/4)
Ambient temperature operating range			Cooling: 10°C (DB)~ +52°C (DB)											
Sound pressure level	Normal mode	dB (A)	63.0	63.0	64.0	63.0	63.0	64.0	63.0	65.0	65.0	64.0	65.0	65.0
	Silent mode (2)	dB (A)	58.0	58.0	59.0	58.0	58.0	59.0	58.0	60.0	60.0	59.0	60.0	60.0
Sound power level	Normal mode	dB	84.0	84.0	85.0	84.0	84.0	85.0	84.0	86.0	86.0	85.0	86.0	86.0

Appearance											
HP		50	52	54	56	58	60	62	64	66	
Model name		U-8MS3H7 U-10MS3H7 U-12MS3H7 U-18MS3H7 U-24MS3H7	U-10MS3H7 U-18MS3H7 U-24MS3H7	U-12MS3H7 U-18MS3H7 U-24MS3H7	U-8MS3H7 U-24MS3H7 U-24MS3H7	U-10MS3H7 U-24MS3H7 U-24MS3H7	U-12MS3H7 U-24MS3H7 U-24MS3H7	U-14MS3H7 U-24MS3H7 U-24MS3H7	U-16MS3H7 U-24MS3H7 U-24MS3H7	U-18MS3H7 U-24MS3H7 U-24MS3H7	
Power supply		380/400/415V/3-phase/50Hz 380/400V/3-phase/60Hz									
Capacity	Cooling	kW	140.0	145.0	151.0	156.0	162.0	174.0	180.0	185.0	
		BTU/h	477,800	494,900	515,400	532,400	552,900	573,400	593,900	614,300	631,400
EER / COP	Cooling	W/W	3.72	3.75	3.65	3.63	3.64	3.55	3.59	3.50	
Dimensions	H x W x D	mm	1,842 x 3,610 x 1,000	1,842 x 3,610 x 1,000	1,842 x 3,610 x 1,000	1,842 x 3,970 x 1,000	1,842 x 3,970 x 1,000	1,842 x 3,970 x 1,000	1,842 x 4,380 x 1,000	1,842 x 4,380 x 1,000	
		kg	889	889	889	942	942	942	1,045	1,045	1,045
Electrical ratings	Cooling	Running current	A	62.8 / 59.6 / 57.5	64.6 / 61.4 / 59.2	69.1 / 65.7 / 63.3	71.0 / 67.5 / 65.0	73.5 / 69.8 / 67.3	78.1 / 74.2 / 71.5	79.6 / 75.7 / 72.9	82.9 / 78.8 / 75.9
		Power input	kW	37.6	38.7	41.4	43.0	44.5	47.3	50.2	52.9
Starting current		A	5	5	5	5	5	6	6	6	
Air flow rate		m³/h	51,660	51,660	51,660	62,040	62,040	62,040	62,520	62,520	
		L/s	14,350	14,350	14,350	17,233	17,233	17,233	17,367	17,367	
Refrigerant amount at shipment		kg	23.4	23.4	23.4	24.6	24.6	24.6	27.3	27.3	
External static pressure		Pa	80	80	80	80	80	80	80	80	
Piping connections	Gas pipe	mm (inches)	Ø41.28 (Ø1-5/8)	Ø41.28 (Ø1-5/8)	Ø41.28 (Ø1-5/8)	Ø41.28 (Ø1-5/8)	Ø41.28 (Ø1-5/8)	Ø41.28 (Ø1-5/8)	Ø41.28 (Ø1-5/8)	Ø41.28 (Ø1-5/8)	
	Liquid pipe	mm (inches)	Ø19.05 (Ø3/4)	Ø19.05 (Ø3/4)	Ø19.05 (Ø3/4)	Ø19.05 (Ø3/4)	Ø19.05 (Ø3/4)	Ø19.05 (Ø3/4)	Ø19.05 (Ø3/4)	Ø19.05 (Ø3/4)	
	Balance pipe	mm (inches)	Ø6.35 (Ø1/4)	Ø6.35 (Ø1/4)	Ø6.35 (Ø1/4)	Ø6.35 (Ø1/4)	Ø6.35 (Ø1/4)	Ø6.35 (Ø1/4)	Ø6.35 (Ø1/4)	Ø6.35 (Ø1/4)	
Ambient temperature operating range			Cooling: 10°C (DB)~ +52°C (DB)								
Sound pressure level	Normal mode	dB (A)	65.0	66.0	66.0	65.0	66.0	66.0	66.0	67.0	
	Silent mode (2)	dB (A)	60.0	61.0	61.0	60.0	61.0	61.0	61.0	62.0	
Sound power level	Normal mode	dB	86.0	87.0	87.0	86.0	87.0	87.0	87.0	88.0	

Appearance														
HP		68	70	72	74	76	78	80	82	84	86	88	90	
Model name		U-68MS3H7SP U-20MS3H7 U-24MS3H7 U-24MS3H7	U-70MS3H7SP U-22MS3H7 U-24MS3H7 U-24MS3H7	U-72MS3H7SP U-24MS3H7 U-24MS3H7 U-24MS3H7	U-74MS3H7SP U-8MS3H7 U-18MS3H7 U-24MS3H7 U-24MS3H7	U-76MS3H7SP U-10MS3H7 U-18MS3H7 U-24MS3H7 U-24MS3H7	U-78MS3H7SP U-12MS3H7 U-18MS3H7 U-24MS3H7 U-24MS3H7	U-80MS3H7SP U-8MS3H7 U-10MS3H7 U-24MS3H7 U-24MS3H7	U-82MS3H7SP U-10MS3H7 U-12MS3H7 U-24MS3H7 U-24MS3H7	U-84MS3H7SP U-12MS3H7 U-14MS3H7 U-24MS3H7 U-24MS3H7	U-86MS3H7SP U-14MS3H7 U-16MS3H7 U-24MS3H7 U-24MS3H7	U-88MS3H7SP U-16MS3H7 U-18MS3H7 U-24MS3H7 U-24MS3H7	U-90MS3H7SP U-18MS3H7 U-24MS3H7 U-24MS3H7	
Power supply		380/400/415V/3-phase/50Hz 380/400V/3-phase/60Hz												
Capacity	Cooling	kW	190.0	196.0	202.0	208.0	213.0	219.0	224.0	232.0	238.0	244.0	249.0	254.0
		BTU/h	648,500	668,900	689,400	709,900	727,000	747,400	764,500	791,800	812,300	832,800	849,800	866,900
EER / COP	Cooling	W/W	3.53	3.49	3.44	3.62	3.64	3.57	3.56	3.56	3.50	3.57	3.47	
Dimensions	H x W x D	mm	1,842 x 4,740 x 1,000	1,842 x 4,740 x 1,000	1,842 x 4,740 x 1,000	1,842 x 5,210 x 1,000	1,842 x 5,210 x 1,000	1,842 x 5,210 x 1,000	1,842 x 5,210 x 1,000					

Cooling Only FSV-EX MS3 Series

SPACE SAVING COMBINATION MODEL



Appearance						
HP		92	94	96		
		U-92MS3H7SP	U-94MS3H7SP	U-96MS3H7SP		
Model name		U-20MS3H7 U-24MS3H7 U-24MS3H7	U-22MS3H7 U-24MS3H7 U-24MS3H7	U-24MS3H7 U-24MS3H7 U-24MS3H7		
Power supply		380/400/415V/3-phase/50Hz 380/400/3-phase/60Hz				
Capacity	Cooling	kW	260.0	266.0	272.0	
		BTU/h	887,400	907,800	928,300	
EER / COP	Cooling	W/W	3.49	3.45	3.42	
Dimensions	H x W x D	mm	1,842 x 6,340 x 1,000	1,842 x 6,340 x 1,000	1,842 x 6,340 x 1,000	
			Net weight	kg	1,464	1,464
Electrical ratings	Cooling	Running current	A	123.0 / 116.9 / 112.7	127.2 / 120.8 / 116.4	131.3 / 124.7 / 120.2
		Power input	kW	74.5	77.0	79.5
Starting current		A	8	8	8	
Air flow rate		m ³ /h	97,200	97,200	97,200	
		L/s	27,000	27,000	27,000	
Refrigerant amount at shipment		kg	38.0	38.0	38.0	
External static pressure		Pa	80	80	80	
Piping connections	Gas pipe	mm (inches)	Ø53.98 (Ø2-1/8)	Ø53.98 (Ø2-1/8)	Ø53.98 (Ø2-1/8)	
	Liquid pipe	mm (inches)	Ø22.22 (Ø7/8)	Ø22.22 (Ø7/8)	Ø22.22 (Ø7/8)	
	Balance pipe	mm (inches)	Ø6.35 (Ø1/4)	Ø6.35 (Ø1/4)	Ø6.35 (Ø1/4)	
Ambient temperature operating range			Cooling: 10°C (DB)~ +52°C (DB)			
Sound pressure level	Normal mode	dB (A)	67.0	68.0	68.0	
	Silent mode (2)	dB (A)	62.0	63.0	63.0	
Sound power level	Normal mode	dB	88.0	89.0	89.0	

GLOBALREMARKS

Rated conditions:	Cooling
Indoor air temperature	27°C DB / 19°C WB
Outdoor air temperature	35°C DB

These specifications are subject to change without notice.

8 / 10 / 12 HP

According to the installation site, you may choose the setting position in the depth direction of the anchor bolt from A, B or C.

A: (Installation hole pitch) For removing tube forward
 B: (Installation hole pitch) For removing the downward
 C: (Installation hole pitch)

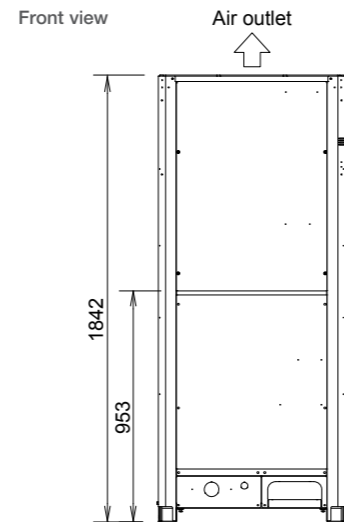
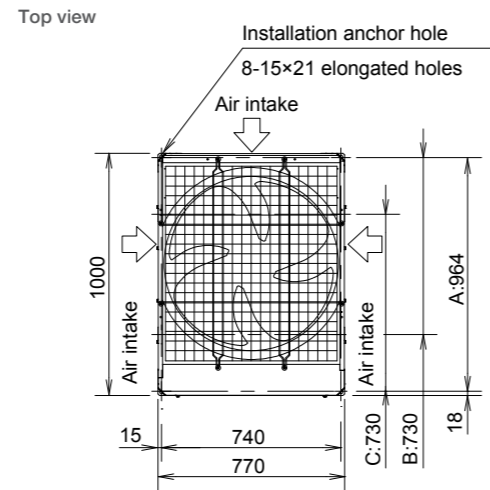

unit: mm

14 / 16 / 18 HP

According to the installation site, you may choose the setting position in the depth direction of the anchor bolt from A, B or C.

A: (Installation hole pitch) For removing tube forward
 B: (Installation hole pitch) For removing the downward
 C: (Installation hole pitch)

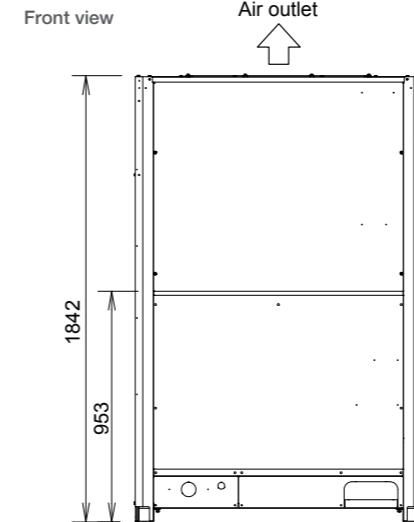
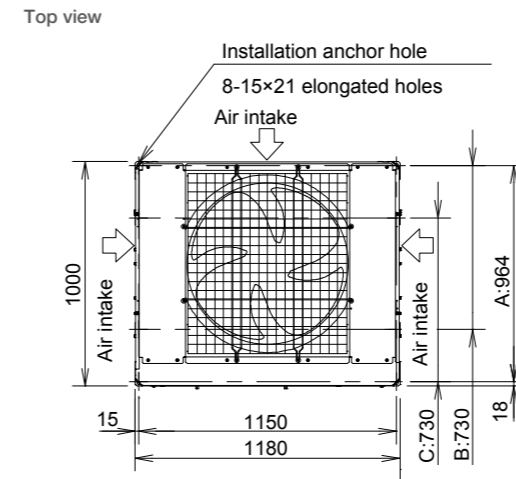

unit: mm

20 / 22 / 24 HP

According to the installation site, you may choose the setting position in the depth direction of the anchor bolt from A, B or C.

A: (Installation hole pitch) For removing tube forward
 B: (Installation hole pitch) For removing the downward
 C: (Installation hole pitch)

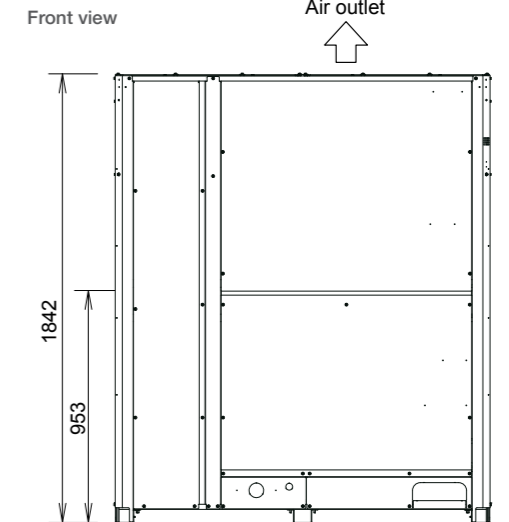
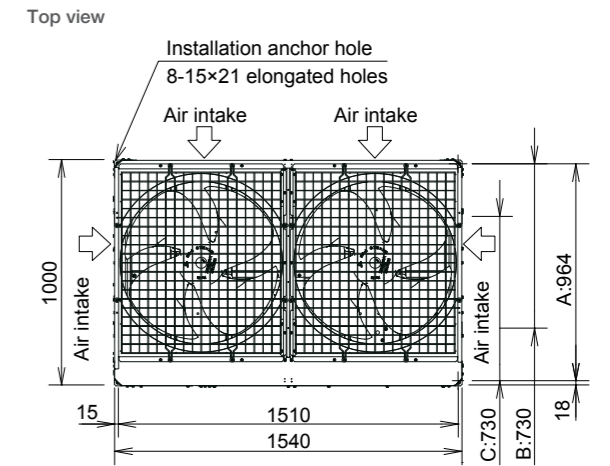

unit: mm

2-WAY FSV-EX ME2 Series

High Efficiency Combination Model

Appearance														
HP		8	10	12	14	16	18	20	22	24	26			
Model name		U-8ME2H7 U-10ME2H7	U-12ME2H7 U-14ME2H7	U-16ME2H7 U-18ME2H7	U-20ME2H7 U-22ME2H7	U-24ME2H7 U-26ME2H7	U-28ME2H7 U-30ME2H7	U-32ME2H7 U-34ME2H7	U-36ME2H7 U-38ME2H7	U-40ME2H7 U-42ME2H7	U-44ME2H7 U-46ME2H7	U-48ME2H7 U-50ME2H7	U-52ME2H7 U-54ME2H7	
Power supply		380/400/415V/3-phase/50Hz 380/400V/3-phase/60Hz												
Capacity	Cooling	kW	22.4	28.0	33.5	40.0	45.0	50.0	56.0	61.5	68.0	73.0		
	BTU/h		76,500	95,600	114,300	136,500	153,600	170,600	191,100	209,900	232,100	249,100		
EER / COP	Cooling	W/W	5.30	5.03	4.73	4.56	4.13	5.15	5.05	4.84	4.69	4.42		
	Heating	W/W	5.84	5.56	5.38	5.29	5.13	5.71	5.58	5.48	5.31	5.29		
Dimensions	H x W x D	mm	1,842 x 770 x 1,000	1,842 x 770 x 1,000	1,842 x 1,180 x 1,000	1,842 x 1,180 x 1,000	1,842 x 1,180 x 1,000	1,842 x 1,600 x 1,000	1,842 x 1,600 x 1,000	1,842 x 2,010 x 1,000	1,842 x 2,420 x 1,000	1,842 x 2,010 x 1,000		
Net weight		kg	210	210	270	315	315	420	420	480	540	525		
Electrical ratings	Cooling	Running current	A	7.14 / 6.78 / 6.54	9.62 / 9.14 / 8.81	11.8 / 11.2 / 10.8	15.3 / 14.5 / 14.0	18.4 / 17.5 / 16.8	16.6 / 15.7 / 15.2	19.2 / 18.2 / 17.5	21.4 / 20.4 / 19.6	24.2 / 23.0 / 22.2	28.2 / 26.8 / 25.8	
		Power input	kW	4.23	5.57	7.08	8.77	10.9	9.70	11.1	12.7	14.5	16.5	
	Heating	Running current	A	7.15 / 6.79 / 6.54	9.68 / 9.20 / 8.86	11.6 / 11.1 / 10.7	14.9 / 14.1 / 13.6	16.6 / 15.8 / 15.2	16.5 / 15.7 / 15.1	19.3 / 18.3 / 17.7	21.3 / 20.2 / 19.5	24.0 / 22.8 / 22.0	26.3 / 25.0 / 24.1	
		Power input	kW	4.28	5.67	6.97	8.51	9.75	9.80	11.3	12.6	14.4	15.4	
Starting current		A	1	1	1	2	2	2	2	2	3			
Air flow rate		m³/h	13,440	13,440	13,920	13,920	13,920	26,880	26,880	27,360	27,840	27,360		
		L/s	3,733	3,733	3,867	3,867	3,867	7,467	7,467	7,600	7,733	7,600		
Refrigerant amount at shipment		kg	5.6	5.6	8.3	8.3	8.3	11.2	11.2	13.9	16.6	13.9		
External static pressure		Pa	80	80	80	80	80	80	80	80	80	80		
Piping connections	Gas pipe	mm (inches)	Ø19.05 (Ø3/4)	Ø22.22 (Ø7/8)	Ø25.40 (Ø1)	Ø25.40 (Ø1)	Ø28.58 (Ø1-1/8)	Ø28.58 (Ø1-1/8)	Ø28.58 (Ø1-1/8)	Ø28.58 (Ø1-1/8)	Ø28.58 (Ø1-1/8)	Ø31.75 (Ø1-1/4)		
	Liquid pipe	mm (inches)	Ø9.52 (Ø3/8)	Ø9.52 (Ø3/8)	Ø12.70 (Ø1/2)	Ø12.70 (Ø1/2)	Ø12.70 (Ø1/2)	Ø15.88 (Ø5/8)	Ø15.88 (Ø5/8)	Ø15.88 (Ø5/8)	Ø15.88 (Ø5/8)	Ø19.05 (Ø3/4)		
	Balance pipe	mm (inches)	Ø6.35 (Ø1/4)	Ø6.35 (Ø1/4)	Ø6.35 (Ø1/4)	Ø6.35 (Ø1/4)	Ø6.35 (Ø1/4)	Ø6.35 (Ø1/4)	Ø6.35 (Ø1/4)	Ø6.35 (Ø1/4)	Ø6.35 (Ø1/4)	Ø6.35 (Ø1/4)		
Ambient temperature operating range			Cooling: -10°C (DB)~ +52°C (DB); Heating: -25°C (WB)~ +18°C (WB)											
Sound pressure level	Normal mode	dB (A)	53.0	56.0	57.0	58.0	61.0	58.0	59.0	59.5	60.0	62.5		
	Silent mode (2)	dB (A)	48.0	51.0	52.0	53.0	56.0	53.0	54.0	54.5	55.0	57.5		
Sound power level	Normal mode	dB	74.0	77.0	78.0	79.0	82.0	79.0	80.0	80.5	81.0	83.5		

Appearance								
HP		56	58	60	62	64		
Model name		U-56ME2H7 U-58ME2H7 U-60ME2H7 U-62ME2H7	U-60ME2H7 U-62ME2H7 U-64ME2H7 U-66ME2H7	U-66ME2H7 U-68ME2H7 U-70ME2H7 U-72ME2H7	U-72ME2H7 U-74ME2H7 U-76ME2H7 U-78ME2H7	U-78ME2H7 U-80ME2H7 U-82ME2H7 U-84ME2H7		
Power supply		380/400/415V/3-phase/50Hz 380/400V/3-phase/60Hz						
Capacity	Cooling	kW	156.0	162.0	168.0	174.0	180.0	
	BTU/h		532,400	552,900	573,400	593,900	614,300	
EER / COP	Cooling	W/W	4.38	4.27	4.24	4.23	4.13	
	Heating	W/W	5.24	5.19	5.15	5.16	5.11	
Dimensions	H x W x D	mm	1,842 x 4,900 x 1,000	1,842 x 4,490 x 1,000	1,842 x 4,900 x 1,000	1,842 x 4,900 x 1,000	1,842 x 4,900 x 1,000	
Net weight		kg	1,170	1,155	1,215	1,260	1,260	
Electrical ratings	Cooling	Running current	A	60.1 / 57.1 / 55.0	64.0 / 60.8 / 58.6	66.9 / 63.5 / 61.2	70.2 / 66.7 / 64.2	73.6 / 69.9 / 67.4
		Power input	kW	35.6	37.9	39.6	41.1	43.6
	Heating	Running current	A	56.4 / 53.6 / 51.6	59.9 / 56.9 / 54.9	62.7 / 59.5 / 57.4	64.5 / 61.3 / 59.1	67.1 / 63.7 / 61.4
		Power input	kW	33.4	35.1	36.7	37.8	39.3
Starting current		A	6	7	7	8	8	
Air flow rate		m³/h	55,680	55,200	55,680	55,680	55,680	
		L/s	15,467	15,333	15,467	15,467	15,467	
Refrigerant amount at shipment		kg	33.2	30.5	33.2	33.2	33.2	
External static pressure		Pa	80	80	80	80	80	
Piping connections	Gas pipe	mm (inches)	Ø38.10 (Ø1-1/2)	Ø38.10 (Ø1-1/2)	Ø38.10 (Ø1-1/2)	Ø41.28 (Ø1-5/8)	Ø41.28 (Ø1-5/8)	
	Liquid pipe	mm (inches)	Ø19.05 (Ø3/4)	Ø19.05 (Ø3/4)	Ø19.05 (Ø3/4)	Ø19.05 (Ø3/4)	Ø19.05 (Ø3/4)	
	Balance pipe	mm (inches)	Ø6.35 (Ø1/4)	Ø6.35 (Ø1/4)	Ø6.35 (Ø1/4)	Ø6.35 (Ø1/4)	Ø6.35 (Ø1/4)	
Ambient temperature operating range			Cooling: -10°C (DB)~ +52°C (DB); Heating: -25°C (WB)~ +18°C (WB)					
Sound pressure level	Normal mode	dB (A)	65.5	66.5	66.5	66.5	67.0	
	Silent mode	dB (A)	60.5	61.5	61.5	61.5	62.0	
Sound power level	Normal mode	dB	86.5	87.5	87.5	87.5	88.0	

Global remarks

Rated conditions:	Cooling	Heating
Indoor air temperature	27°C DB / 19°C WB	20°C DB
Outdoor air temperature	35°C DB	7°C DB / 6°C WB

These specifications are subject to change without notice. High durable model (with suffix "E") has same specifications.



28	30	32	34	36	38	40	42	44	46	48	50	52	54
U-28ME2H7	U-30ME2H7	U-32ME2H7	U-34ME2H7E	U-36ME2H7E	U-38ME2H7E	U-40ME2H7E	U-42ME2H7	U-44ME2H7	U-46ME2H7	U-48ME2H7	U-50ME2H7E	U-52ME2H7E	U-54ME2H7E
U-12ME2H7 U-16ME2H7	U-14ME2H7 U-16ME2H7	U-16ME2H7 U-16ME2H7	U-10ME2H7 U-12ME2H7 U-12ME2H7	U-12ME2H7 U-12ME2H7 U-12ME2H7	U-10ME2H7 U-12ME2H7 U-16ME2H7	U-12ME2H7 U-12ME2H7 U-16ME2H7	U-10ME2H7 U-16ME2H7 U-16ME2H7	U-12ME2H7 U-16ME2H7 U-16ME2H7	U-14ME2H7 U-16ME2H7 U-16ME2H7	U-16ME2H7 U-16ME2H7 U-16ME2H7	U-10ME2H7 U-12ME2H7 U-12ME2H7 U-16ME2H7	U-12ME2H7 U-12ME2H7 U-12ME2H7 U-16ME2H7	U-10ME2H7 U-12ME2H7 U-12ME2H7 U-16ME2H7
380/400/415V/3-phase/50Hz 380/400V/3-phase/60Hz													
78.5	85.0	90.0	96.0	101.0	107.0	113.0	118.0	124.0	130.0	135.0	140.0	145.0	151.0
267,900	290,100	307,200	327,600	344,700	365,200	385,700	402,700	423,200	443,700	460,800	477,800	494,900	515,400
87.5	95.0	100.0	108.0	113.0	119.0	127.0	132.0	138.0	145.0	150.0	155.0	160.0	169.0
298,600	324,200	341,300	368,600	385,700	406,100	433,400	450,500	471,000	494,900	511,900	529,000	546,100	576,800
4.36	4.31	4.13	4.80	4.72	4.51	4.45	4.31	4.26	4.25	4.13	4.58	4.53	4.40
5.24	5.19	5.13	5.40	5.38	5.31	5.23	5.22	5.19	5.18	5.12	5.36	5.33	5.26
1,842 x 2,420 x 1,000	1,842 x 2,420 x 1,000	1,842 x 2,420 x 1,000	1,842 x 3,250 x 1,000	1,842 x 3,660 x 1,000	1,842 x 3,250 x 1,000	1,842 x 3,660 x 1,000	1,842 x 3,250 x 1,000	1,842 x 3,660 x 1,000	1,842 x 3,660 x 1,000	1,842 x 3,660 x 1,000	1,842 x 4,490 x 1,000	1,842 x 4,900 x 1,000	1,842 x 4,490 x 1,000
585	630	630	750	810	795	855	840	900	945	945	1,065	1,125	1,110
30.4 / 28.9 / 27.8	33.6 / 31.9 / 30.8	36.8 / 35.0 / 33.7	33.8 / 32.1 / 30.9	35.7 / 33.9 / 32.7	40.0 / 38.0 / 36.6	42.4 / 40.3 / 38.8	46.3 / 43.9 / 42.4	49.1 / 46.7 / 45.0	52.2 / 49.6 / 47.8	55.2 / 52.4 / 50.5	51.7 / 49.1 / 47.3	53.4 / 50.8 / 48.9	57.9 / 55.0 / 53.0
18.0	19.7	21.8	20.0	21.4	23.7	25.4	27.4	29.1	30.6	32.7	30.6	32.0	34.3
28.2 / 26.8 / 25.8	31.6 / 30.0 / 28.9	33.3 / 31.6 / 30.5	33.8 / 32.1 / 30.9	35.1 / 33.3 / 32.1	37.8 / 35.9 / 34.6	41.0 / 39.0 / 37.6	43.2 / 41.0 / 39.5	44.9 / 42.7 / 41.1	48.3 / 45.9 / 44.3	50.0 / 47.5 / 45.8	48.8 / 46.3 / 44.7	50.6 / 48.1 / 46.4	54.8 / 52.1 / 50.2
16.7	18.3	19.5	20.0	21.0	22.4	24.3	25.3	26.6	28.0	29.3	28.9	30.0	32.1
3	4	4	3	3	4	4	5	5	6	6	5	5	6
27,840	27,840	27,840	41,280	41,760	41,280	41,760	41,280	41,760	41,760	41,760	55,200	55,680	55,200
7,733	7,733	7,733	11,467	11,600	11,467	11,600	11,467	11,600	11,600	11,600	15,333	15,467	15,333
16.6	16.6	16.6	22.2	24.9	22.2	24.9	22.2	24.9	24.9	24.9	30.5	33.2	30.5
80	80	80	80	80	80	80	80	80	80	80	80	80	80
Ø31.75 (Ø1-1/4)	Ø31.75 (Ø1-1/4)	Ø31.75 (Ø1-1/4)	Ø31.75 (Ø1-1/4)	Ø38.10 (Ø1-1/2)	Ø38.10 (Ø1-1/2)	Ø38.10 (Ø1-1/2)	Ø38.10 (Ø1-1/2)	Ø38.10 (Ø1-1/2)	Ø38.10 (Ø1-1/2)	Ø38.10 (Ø1-1/2)	Ø38.10 (Ø1-1/2)	Ø38.10 (Ø1-1/2)	Ø38.10 (Ø1-1/2)
Ø19.05 (Ø3/4)	Ø19.05 (Ø3/4)	Ø19.05 (Ø3/4)	Ø19.05 (Ø3/4)	Ø19.05 (Ø3/4)	Ø19.05 (Ø3/4)	Ø19.05 (Ø3/4)	Ø19.05 (Ø3/4)	Ø19.05 (Ø3/4)	Ø19.05 (Ø3/4)	Ø19.05 (Ø3/4)	Ø19.05 (Ø3/4)	Ø19.05 (Ø3/4)	Ø19.05 (Ø3/4)
Ø6.35 (Ø1/4)	Ø6.35 (Ø1/4)	Ø6.35 (Ø1/4)	Ø6.35 (Ø1/4)	Ø6.35 (Ø1/4)	Ø6.35 (Ø1/4)	Ø6.35 (Ø1/4)	Ø6.35 (Ø1/4)	Ø6.35 (Ø1/4)	Ø6.35 (Ø1/4)	Ø6.35 (Ø1/4)	Ø6.35 (Ø1/4)	Ø6.35 (Ø1/4)	Ø6.35 (Ø1/4)
Cooling: -10°C (DB)~ +52°C (DB); Heating: -25°C (WB)~ +18°C (WB)													
62.5	63.0	64.0	61.5	62.0	63.5	63.5	65.0	65.0	65.0	66.0	64.5	64.5	65.5
57.5	58.0	59.0	56.5	57.0	58.5	58.5	60.0	60.0	60.0	61.0	59.5	59.5	60.5
83.5	84.0	85.0	82.5	83.0	84.5	84.5	86.0						

2-WAY FSV-EX ME2 Series

Space-saving Combination Model

Appearance											
HP		8	10	12	14	16	18	20	22	24	
Model name		U-8ME2H7	U-10ME2H7	U-12ME2H7	U-14ME2H7	U-16ME2H7	U-18ME2H7	U-20ME2H7	U-10ME2H7 U-12ME2H7	U-12ME2H7 U-12ME2H7	
Power supply		380/400/415V/3-phase/50Hz 380/400V/3-phase/60Hz									
Capacity	Cooling	kW	22.4	28.0	33.5	40.0	45.0	50.0	56.0	61.5	68.0
		BTU/h	76,500	95,600	114,300	136,500	153,600	170,600	191,100	209,900	232,100
EER / COP	Cooling	W/W	5.30	5.03	4.73	4.56	4.13	4.10	3.76	4.84	4.69
		W/W	5.84	5.56	5.38	5.29	5.13	5.05	4.60	5.48	5.31
Dimensions	H x W x D	mm	1,842 x 770 x 1,000	1,842 x 770 x 1,000	1,842 x 1,180 x 1,000	1,842 x 1,180 x 1,000	1,842 x 1,180 x 1,000	1,842 x 1,540 x 1,000	1,842 x 1,540 x 1,000	1,842 x 2,010 x 1,000	1,842 x 2,420 x 1,000
		kg	210	210	270	315	315	375	375	480	540
Electrical ratings	Cooling	Running current A	7.14 / 6.78 / 6.54	9.62 / 9.14 / 8.81	11.8 / 11.2 / 10.8	15.3 / 14.5 / 14.0	18.4 / 17.5 / 16.8	20.6 / 19.6 / 18.9	24.6 / 23.4 / 22.5	21.4 / 20.4 / 19.6	24.2 / 23.0 / 22.2
		Power input kW	4.23	5.57	7.08	8.77	10.9	12.2	14.9	12.7	14.5
	Heating	Running current A	7.15 / 6.79 / 6.54	9.68 / 9.20 / 8.86	11.6 / 11.1 / 10.7	14.9 / 14.1 / 13.6	16.6 / 15.8 / 15.2	18.9 / 18.0 / 17.4	22.9 / 21.7 / 20.9	21.3 / 20.2 / 19.5	24.0 / 22.8 / 22.0
		Power input kW	4.28	5.67	6.97	8.51	9.75	11.1	13.7	12.6	14.4
Starting current	A	1	1	1	2	2	2	2	2	2	
Air flow rate	m³/h	13,440	13,440	13,920	13,920	13,920	24,300	24,300	27,360	27,840	
	L/s	3,733	3,733	3,867	3,867	3,867	6,750	6,750	7,600	7,733	
Refrigerant amount at shipment	kg	5.6	5.6	8.3	8.3	8.3	9.5	9.5	13.9	16.6	
External static pressure	Pa	80	80	80	80	80	80	80	80	80	
Piping connections	Gas pipe	mm (inches)	Ø19.05 (Ø3/4)	Ø22.22 (Ø7/8)	Ø25.40 (Ø1)	Ø25.40 (Ø1)	Ø28.58 (Ø1-1/8)	Ø28.58 (Ø1-1/8)	Ø28.58 (Ø1-1/8)	Ø28.58 (Ø1-1/8)	Ø28.58 (Ø1-1/8)
	Liquid pipe	mm (inches)	Ø9.52 (Ø3/8)	Ø9.52 (Ø3/8)	Ø12.70 (Ø1/2)	Ø12.70 (Ø1/2)	Ø12.70 (Ø1/2)	Ø15.88 (Ø5/8)	Ø15.88 (Ø5/8)	Ø15.88 (Ø5/8)	Ø15.88 (Ø5/8)
	Balance pipe	mm (inches)	Ø6.35 (Ø1/4)	Ø6.35 (Ø1/4)	Ø6.35 (Ø1/4)	Ø6.35 (Ø1/4)	Ø6.35 (Ø1/4)	Ø6.35 (Ø1/4)	Ø6.35 (Ø1/4)	Ø6.35 (Ø1/4)	Ø6.35 (Ø1/4)
Ambient temperature operating range		Cooling: -10°C (DB)~ +52°C (DB); Heating: -25°C (WB)~ +18°C (WB)									
Sound pressure level	Normal mode	dB (A)	53.0	56.0	57.0	58.0	61.0	59.0	59.0	59.5	60.0
	Silent mode (2)	dB (A)	48.0	51.0	52.0	53.0	56.0	54.0	54.0	54.5	55.0
Sound power level	Normal mode	dB	74.0	77.0	78.0	79.0	82.0	80.0	80.0	80.5	81.0

Appearance											
HP		50	52	54	56	58	60	62	64	66	
Model name		U-14ME2H7 U-16ME2H7 U-20ME2H7	U-16ME2H7 U-16ME2H7 U-20ME2H7	U-14ME2H7 U-20ME2H7 U-20ME2H7	U-16ME2H7 U-20ME2H7 U-20ME2H7	U-18ME2H7 U-20ME2H7 U-20ME2H7	U-20ME2H7 U-20ME2H7 U-20ME2H7	U-14ME2H7 U-16ME2H7 U-16ME2H7	U-16ME2H7 U-16ME2H7 U-16ME2H7	U-10ME2H7 U-16ME2H7 U-20ME2H7	
Power supply		380/400/415V/3-phase/50Hz 380/400V/3-phase/60Hz									
Capacity	Cooling	kW	140.0	145.0	151.0	156.0	162.0	168.0	174.0	180.0	185.0
		BTU/h	477,800	494,900	515,400	532,400	552,900	573,400	593,900	614,300	631,400
EER / COP	Cooling	W/W	4.09	3.99	3.95	3.87	3.86	3.76	4.23	4.13	4.00
		W/W	5.00	4.95	4.79	4.76	4.73	4.60	5.16	5.11	4.85
Dimensions	H x W x D	mm	1,842 x 4,020 x 1,000	1,842 x 4,020 x 1,000	1,842 x 4,380 x 1,000	1,842 x 4,380 x 1,000	1,842 x 4,740 x 1,000	1,842 x 4,740 x 1,000	1,842 x 4,900 x 1,000	1,842 x 4,900 x 1,000	1,842 x 5,210 x 1,000
		kg	1,005	1,005	1,065	1,065	1,125	1,125	1,260	1,260	1,275
Electrical ratings	Cooling	Running current A	57.7 / 54.8 / 52.9	60.6 / 57.6 / 55.5	63.8 / 60.6 / 58.4	67.3 / 63.9 / 61.6	70.1 / 66.6 / 64.2	73.8 / 70.1 / 67.6	70.2 / 66.7 / 64.2	73.6 / 69.9 / 67.4	77.3 / 73.4 / 70.8
		Power input kW	34.2	36.3	38.2	40.3	42.0	44.7	41.1	43.6	46.3
	Heating	Running current A	52.9 / 50.3 / 48.5	54.5 / 51.8 / 49.9	59.6 / 56.6 / 54.6	62.1 / 59.0 / 56.9	65.0 / 61.7 / 59.5	68.6 / 65.2 / 62.8	64.5 / 61.3 / 59.1	67.1 / 63.7 / 61.4	72.1 / 68.5 / 66.0
		Power input kW	31.0	32.3	35.3	36.8	38.5	41.1	37.8	39.3	42.7
Starting current	A	6	6	6	6	6	6	8	8	7	
Air flow rate	m³/h	52,140	52,140	62,520	62,520	72,900	72,900	55,680	55,680	75,960	
	L/s	14,483	14,483	17,367	17,367	20,250	20,250	15,467	15,467	21,100	
Refrigerant amount at shipment	kg	26.1	26.1	27.3	27.3	28.5	28.5	33.2	33.2	32.9	
External static pressure	Pa	80	80	80	80	80	80	80	80	80	
Piping connections	Gas pipe	mm (inches)	Ø38.10 (Ø1-1/2)	Ø38.10 (Ø1-1/2)	Ø38.10 (Ø1-1/2)	Ø38.10 (Ø1-1/2)	Ø38.10 (Ø1-1/2)	Ø41.28 (Ø1-5/8)	Ø41.28 (Ø1-5/8)	Ø41.28 (Ø1-5/8)	
	Liquid pipe	mm (inches)	Ø19.05 (Ø3/4)	Ø19.05 (Ø3/4)	Ø19.05 (Ø3/4)	Ø19.05 (Ø3/4)	Ø19.05 (Ø3/4)	Ø19.05 (Ø3/4)	Ø19.05 (Ø3/4)	Ø19.05 (Ø3/4)	
	Balance pipe	mm (inches)	Ø6.35 (Ø1/4)	Ø6.35 (Ø1/4)	Ø6.35 (Ø1/4)	Ø6.35 (Ø1/4)	Ø6.35 (Ø1/4)	Ø6.35 (Ø1/4)	Ø6.35 (Ø1/4)	Ø6.35 (Ø1/4)	
Ambient temperature operating range		Cooling: -10°C (DB)~ +52°C (DB); Heating: -25°C (WB)~ +18°C (WB)									
Sound pressure level	Normal mode	dB (A)	64.5	65.5	63.5	64.0	64.0	66.5	67.0	65.5	65.5
	Silent mode	dB (A)	59.5	60.5	58.5	59.5	59.0	59.0	61.5	62.0	60.5
Sound power level	Normal mode	dB	85.5	86.5	84.5	85.5	85.0	85.0	87.5	88.0	86.5

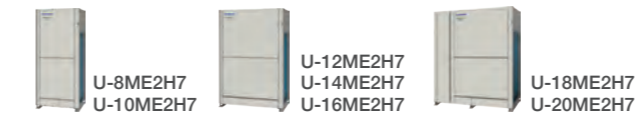

Appearance														
HP		26	28	30	32	34	36	38	40	42	44	46	48	
Model name		U-10ME2H7 U-16ME2H7	U-12ME2H7 U-16ME2H7	U-14ME2H7 U-16ME2H7	U-16ME2H7 U-16ME2H7	U-14ME2H7 U-20ME2H7	U-16ME2H7 U-20ME2H7	U-18ME2H7 U-20ME2H7	U-20ME2H7 U-20ME2H7	U-10ME2H7 U-16ME2H7 U-16ME2H7	U-12ME2H7 U-16ME2H7 U-16ME2H7	U-14ME2H7 U-16ME2H7 U-16ME2H7	U-16ME2H7 U-16ME2H7 U-16ME2H7	
Power supply		380/400/415V/3-phase/50Hz 380/400V/3-phase/60Hz												
Capacity	Cooling	kW	73.0	78.5	85.0	90.0	96.0	101.0	107.0	113.0	118.0	124.0	130.0	135.0
		BTU/h	249,100	267,900	290,100	307,200	327,600	344,700	365,200	385,700	402,700	423,200	443,700	460,800
EER / COP	Cooling	W/W	81.5	87.5	95.0	100.0	108.0	113.0	119.0	127.0	132.0	138.0	145.0	150.0
		W/W	278,200	298,600	324,200	341,300	368,600	385,700	406,100	433,400	450,500	471,000	494,900	511,900
Electrical ratings	Cooling	Running current A	4.42	4.36	4.31	4.31	4.05	3.91	3.89	3.74	4.31	4.26	4.25	4.13
		Power input kW	5.29	5.24	5.19	5.13	4.86	4.81	4.80	4.58	5.22	5.19	5.18	5.12
	Heating	Running current A	28.2 / 26.8 / 25.8	30.4 / 28.9 / 27.8	33.6 / 31.9 / 30.8	36.8 / 35.0 / 33.7	40.0 / 38.0 / 36.6	43.1 / 40.9 / 39.4	45.9 / 43.6 / 42.0	49.9 / 47.4 / 45.7	46.3 / 43.9 / 42.4	49.1 / 46.7 / 45.0	52.2 / 49.6 / 47.8	55.2 / 52.4 / 50.5
		Power input kW	16.5	18.0	19.7	21.8	23.7	25.8	27.5	30.2	27.4	29.1	30.6	32.7
Starting current	A	26.3 / 25.0 / 24.1	28.2 / 26.8 / 25.8	31.6 / 30.0 / 28.9	33.3 / 31.6 / 30.5	37.9 / 36.0 / 34.7	39.7 / 37.7 / 36.3	41.9 / 39.8 / 38.3	46.2 / 43.9 / 42.3	43.2 / 41.0 / 39.5	44.9 / 42.7 / 41.1	48.3 / 45.9 / 44.3	50.0 / 47.5 / 45.8	
Air flow rate	m³/h	15.4	16.7	18.3	19.5	22.2	23.5	24.8	27.7	25.3	26.6	28.0	29.3	
	L/s	3	3	4	4	4	4	4	4	5	5	6	6	
Refrigerant amount at shipment	kg	27,360	27,840	27,840	27,840	38,220	38,220	48,600	48,600	41,280	41,760	41,760	41,760	
External static pressure	Pa	7,600	7,733	7,733	7,733	10,617	10,617	13,500	13,500	11,467	11,600	11,600	11,600	
Piping connections	Gas pipe	mm (inches)	Ø31.75 (Ø1-1/4)	Ø31.75 (Ø1-1/4)	Ø31.75 (Ø1-1/4)	Ø31.75 (Ø1-1/4)	Ø31.75 (Ø1-1/4)	Ø31.75 (Ø1-1/4)	Ø31.75 (Ø1-1/4)	Ø38.10 (Ø1-1/2)	Ø38.10 (Ø1-1/2)	Ø38.10 (Ø1-1/2)	Ø38.10 (Ø1-1/2)	
	Liquid pipe	mm (inches)	Ø19.05 (Ø3/4)	Ø19.05 (Ø3/4)	Ø19.05 (Ø3/4)	Ø19.05 (Ø3/4)	Ø19.05 (Ø3/4)	Ø19.05 (Ø3/4)	Ø19.05 (Ø3/4)	Ø19.05 (Ø3/4)	Ø19.05 (Ø3/4)	Ø19.05 (Ø3/4)	Ø19.05 (Ø3/4)	
	Balance pipe	mm (inches)	Ø6.35 (Ø1/4)	Ø6.35 (Ø1/4)	Ø6.35 (Ø1/4)	Ø6.35 (Ø1/4)	Ø6.35 (Ø1/4)	Ø6.35 (Ø1/4)	Ø6.35 (Ø1/4)	Ø6.35 (Ø1/4)	Ø6.35 (Ø1/4)	Ø6.35 (Ø1/4)	Ø6.35 (Ø1/4)	
Ambient temperature operating range		Cooling: -10°C (DB)~ +52°C (DB); Heating: -25°C (WB)~ +18°C (WB)												
Sound pressure level	Normal mode	dB (A)	62.5	62.5	63.0	64.0	61.5	63.5	62.0	65.0	65.0	65.0	66.0	
	Silent mode	dB (A)	57.5	57.5	58.0	59.0	56.5	58.5	57.0	60.0	60.0	60.0	61.0	
Sound power level	Normal mode	dB	83.5	83.5	84.0	85.0	82.5	84.5	83.0	86.0	86.0	86.0	87.0	

Appearance									
HP		68	70	72	74	76	78	80	
Model name		U-12ME2H7 U-16ME2H7 U-20ME2H7 U-20ME2H7	U-10ME2H7 U-16ME2H7 U-20ME2H7 U-20ME2H7	U-16ME2H7 U-16ME2H7 U-20ME2H7 U-20ME2H7	U-16ME2H7 U-18ME2H7 U-20ME2H7 U-20ME2H7	U-16ME2H7 U-20ME2H7 U-20ME2H7 U-20ME2H7	U-18ME2H7 U-20ME2H7 U-20ME2H7 U-20ME2H7	U-20ME2H7 U-20ME2H7 U-20ME2H7 U-20ME2H7	
Power supply		380/400/4							

Simultaneous heating and cooling VRF system 3-WAY FSV-EX MF3 Series

Increased max. number of connectable indoor units

The 3-WAY MF3 series has four DC inverter outdoor units from 16HP as the basic models, and by combination of up to three units, an air-conditioning capacity of 8HP to 48HP can be set according to the user needs.

System (HP)	8	10	12	14	16	18	20	22	24	26	28	30	32	34	36	38	40	42	44	46	48
Outdoor units	8	10	12	14	16	10	12	12	16	16	16	16	16	16	16	16	16	16	16	16	16
Connectable indoor units	15	19	22	27	30	34	38	41	46	49	52	52	52	52	52	52	52	52	52	52	52

Connectable indoor/outdoor unit capacity ratio up to 150%

Long piping design

Adaptable to various building types and sizes
Actual piping length : 200m
Max piping length : 500m

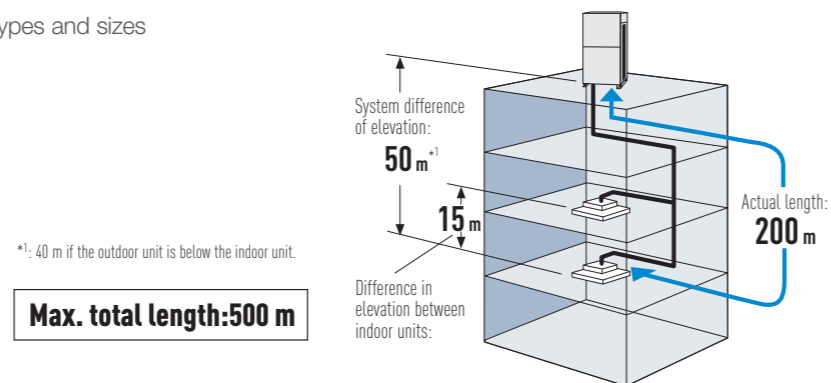

Up to 40m piping after first branch

Up to 52 units can be connected to one system. Flexible piping layout makes it easier to design systems for locations such as train stations, airports, schools and hospitals.

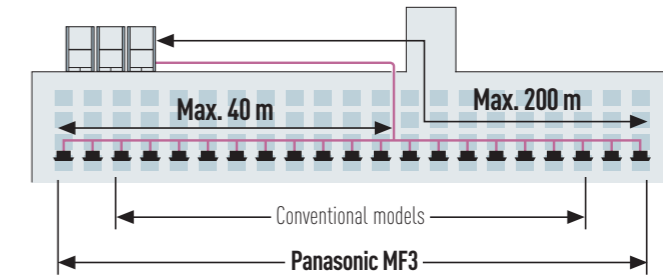

Extended operating range

Cooling operation range:

The cooling operation range has been extended to -10°C DB to +52°C DB by changing the outdoor fan to an inverter type.

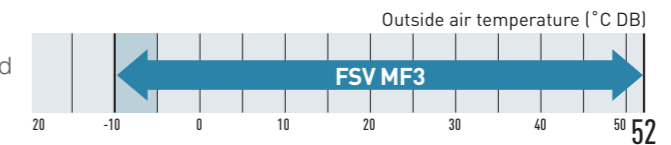

Heating operation range:

Stable heating operation even with an outside air temperature of -20°C WB

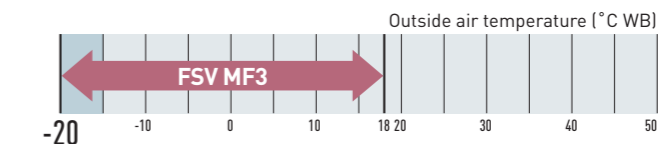

Wide temperature setting range

Wired remote control heating temperature setting range is 16 to 30°C

Remark: Cooling/heating capacity depend on indoor/outdoor temperature. Please refer technical databook.

Excellent energy saving

The operation efficiency has been improved using highly efficient R410A refrigerant, new DC inverter compressor, and new heat exchanger design.

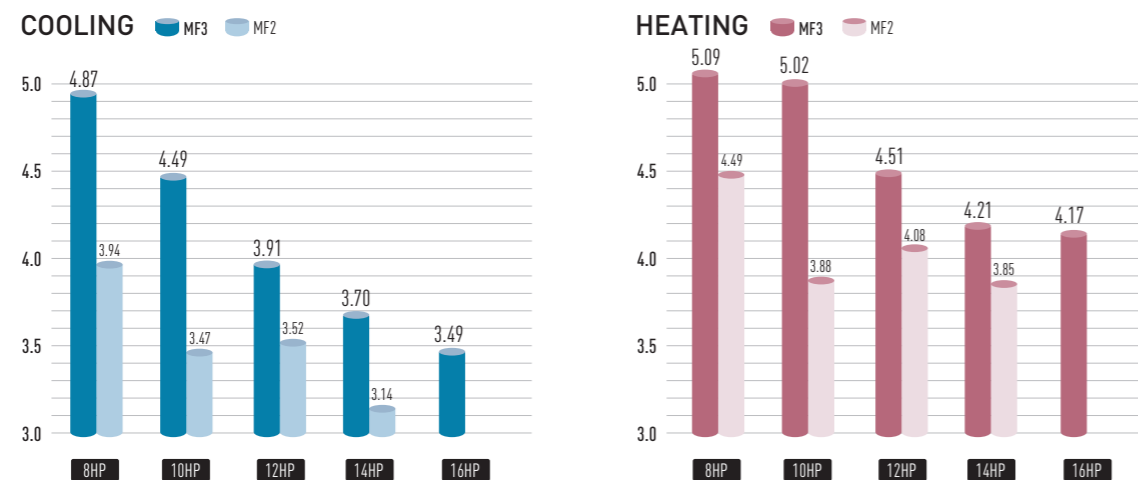

3-WAY FSV-EX MF3 Series

Appearance													
HP		8	10	12	14	16	18	20	22	24	26		
Model name		U-8MF3R7	U-10MF3R7	U-12MF3R7	U-14MF3R7	U-16MF3R7	U-8MF3R7 U-10MF3R7	U-8MF3R7 U-12MF3R7	U-10MF3R7 U-12MF3R7	U-12MF3R7 U-16MF3R7	U-10MF3R7 U-16MF3R7		
Power supply		380/400/415V/3-phase/50Hz 380/400V/3-phase/60											
Capacity	Cooling	kW	22.4	28.0	33.5	40.0	45.0	50.0	56.0	61.5	68.0	73.0	
		BTU/h	76,500	95,600	114,300	136,500	153,600	170,600	191,100	209,900	232,100	249,100	
	Heating	kW	25.0	31.5	37.5	45.0	50.0	56.0	63.0	69.0	76.5	81.5	
		BTU/h	85,300	107,500	128,000	153,600	170,600	191,100	215,000	235,500	261,100	278,200	
EER / COP	Cooling	W/W	4.87	4.49	3.91	3.70	3.49	4.67	4.24	4.16	3.89	3.82	
	Heating	W/W	5.09	5.02	4.51	4.21	4.17	5.09	4.70	4.73	4.47	4.45	
Dimensions	H x W x D	mm	1,842x1,180 x1,000	1,842x1,180 x1,000	1,842x1,180 x1,000	1,842x1,180 x1,000	1,842x1,180 x1,000	1,842x2,420 x1,000	1,842x2,420 x1,000	1,842x2,420 x1,000	1,842x2,420 x1,000	1,842x2,420 x1,000	
Net weight		kg	264	265	289	337	337	529	553	553	578	602	
Electrical ratings	Cooling	Running current	A	7.52/7.14/6.88	10.4/9.88/9.52	13.9/13.2/12.7	18.2/17.3/16.7	21.3/20.2/12.9	17.7/16.8/16.2	21.3/20.3/19.5	24.2/23.0/22.1	28.3/26.9/25.9	31.5/30.0/28.9
		Power input	kW	4.60	6.23	8.57	10.8	12.9	10.7	13.2	14.8	17.5	19.1
	Heating	Running current	A	8.02/7.62/7.34	10.5/9.95/9.59	13.4/12.8/12.3	18.1/17.2/16.5	20.0/19.0/18.3	18.2/17.3/16.6	21.7/20.6/19.8	23.9/22.7/21.8	27.6/26.3/25.3	30.6/29.0/28.0
		Power input	kW	4.91	6.27	8.32	10.7	12.0	11.0	13.4	14.6	17.1	18.3
Air flow rate		m³/h	12,600	13,200	13,920	13,920	13,920	25,800	26,520	27,120	27,840	27,120	
		L/s	3,500	3,667	3,867	3,867	3,867	7,167	7,367	7,533	7,733	7,533	
Refrigerant amount at shipment		kg	9.8	9.8	11.8	11.8	11.8	19.6	21.6	21.6	23.6	21.6	
Piping connections	Suction pipe	mm (inches)	Ø19.05 (Ø3/4)	Ø22.22 (Ø7/8)	Ø25.40 (Ø1)	Ø25.40 (Ø1)	Ø28.58 (Ø1-1/8)	Ø28.58 (Ø1-1/8)	Ø28.58 (Ø1-1/8)	Ø28.58 (Ø1-1/8)	Ø31.75 (Ø1-1/4)	Ø31.75 (Ø1-1/4)	
	Discharge pipe	mm (inches)	Ø15.88 (Ø5/8)	Ø19.05 (Ø3/4)	Ø19.05 (Ø3/4)	Ø22.22 (Ø7/8)	Ø22.22 (Ø7/8)	Ø22.22 (Ø7/8)	Ø22.22 (Ø7/8)	Ø25.40 (Ø1)	Ø25.40 (Ø1)	Ø25.40 (Ø1)	
	Liquid pipe	mm (inches)	Ø9.52 (Ø3/8)	Ø9.52 (Ø3/8)	Ø12.70 (Ø1/2)	Ø12.70 (Ø1/2)	Ø12.70 (Ø1/2)	Ø15.88 (Ø5/8)	Ø15.88 (Ø5/8)	Ø15.88 (Ø5/8)	Ø15.88 (Ø5/8)	Ø19.05 (Ø3/4)	
	Balance pipe	mm (inches)	Ø6.35 (Ø1/4)	Ø6.35 (Ø1/4)	Ø6.35 (Ø1/4)	Ø6.35 (Ø1/4)	Ø6.35 (Ø1/4)	Ø6.35 (Ø1/4)	Ø6.35 (Ø1/4)	Ø6.35 (Ø1/4)	Ø6.35 (Ø1/4)	Ø6.35 (Ø1/4)	
Ambient temperature operating range													
Sound pressure level	Normal mode	dB (A)	54.0	57.0	60.0	61.0	62.0	59.0	61.0	62.0	63.0	63.5	
	Silent mode	dB (A)	49.0	52.0	55.0	56.0	57.0	54.0	56.0	57.0	58.0	58.5	

Appearance														
HP		28	30	32	34	36	38	40	42	44	46	48		
Model name		U-12MF3R7 U-16MF3R7	U-14MF3R7 U-16MF3R7	U-16MF3R7 U-16MF3R7	U-8MF3R7 U-10MF2R7 U-16MF3R7	U-8MF3R7 U-12MF3R7 U-16MF3R7	U-10MF3R7 U-12MF3R7 U-16MF3R7	U-8MF3R7 U-16MF3R7	U-10MF3R7 U-16MF3R7	U-12MF3R7 U-16MF3R7	U-14MF3R7 U-16MF3R7	U-16MF3R7 U-16MF3R7		
Power supply		380/400/415V/3-phase/50Hz 380/400V/3-phase/60												
Capacity	Cooling	kW	78.5	85.0	90.0	96.0	101.0	107.0	113.0	118.0	124.0	130.0	135.0	
		BTU/h	267,900	290,100	307,200	327,600	344,700	365,200	385,700	402,700	423,200	443,700	460,800	
	Heating	kW	87.5	95.0	100.0	108.0	113.0	119.0	127.0	132.0	138.0	145.0	150.0	
		BTU/h	298,600	324,200	341,300	368,600	385,700	406,100	433,400	450,500	471,000	494,900	511,900	
EER / COP	Cooling	W/W	3.65	3.59	3.49	4.00	3.87	3.84	3.69	3.69	3.58	3.55	3.49	
	Heating	W/W	4.31	4.19	4.17	4.56	4.45	4.47	4.29	4.34	4.25	4.18	4.17	
Dimensions	H x W x D	mm	1,842x2,420 x1,000	1,842x2,420 x1,000	1,842x2,420 x1,000	1,842x3,660 x1,000	1,842x3,660 x1,000	1,842x3,660 x1,000	1,842x3,660 x1,000	1,842x3,660 x1,000	1,842x3,660 x1,000	1,842x3,660 x1,000	1,842x3,660 x1,000	
Net weight		kg	626	674	674	866	890	891	938	939	963	1,011	1,011	
Electrical ratings	Cooling	Running current	A	35.133.4/32.2	39.6/37.6/36.2	42.6/40.5/39.0	39.6/37.7/36.3	42.6/40.5/39.0	46.1/43.8/42.2	50.5/48.0/46.3	52.8/50.2/48.4	56.5/53.7/51.8	61.1/58.1/56.0	63.9/60.7/58.5
		Power input	kW	21.5	23.7	25.8	24.0	26.1	27.9	30.6	32.0	34.6	36.6	38.7
	Heating	Running current	A	33.5/31.8/30.7	37.9/36.0/34.7	40.1/38.1/36.7	39.6/37.6/36.2	41.9/39.8/38.4	43.9/41.7/40.2	49.4/46.9/45.3	50.8/48.2/46.5	53.7/51.0/49.1	57.9/55.0/53.0	60.1/57.1/55.0
		Power input	kW	20.3	22.7	24.0	23.7	25.4	26.6	29.6	30.4	32.5	34.7	36.0
Air flow rate		m³/h	27,840	27,840	27,840	39,720	40,440	41,040	40,440	41,040	41,760	41,760	41,760	
		L/s	7,733	7,733	7,733	11,033	11,233	11,400	11,233	11,400	11,600	11,600	11,600	
Refrigerant amount at shipment		kg	23.6	23.6	23.6	31.4	33.4	33.4	33.4	33.4	35.4	35.4	35.4	
Piping connections	Suction pipe	mm (inches)	Ø31.75 (Ø1-1/4)	Ø31.75 (Ø1-1/4)	Ø31.75 (Ø1-1/4)	Ø31.75 (Ø1-1/4)	Ø38.1 (Ø1-1/2)	Ø38.1 (Ø1-1/2)	Ø38.1 (Ø1-1/2)	Ø38.1 (Ø1-1/2)	Ø38.1 (Ø1-1/2)	Ø38.1 (Ø1-1/2)	Ø38.1 (Ø1-1/2)	
	Discharge pipe	mm (inches)	Ø28.58 (Ø1-1/8)	Ø28.58 (Ø1-1/8)	Ø28.58 (Ø1-1/8)	Ø28.58 (Ø1-1/8)	Ø28.58 (Ø1-1/8)	Ø28.58 (Ø1-1/8)	Ø31.75 (Ø1-1/4)	Ø31.75 (Ø1-1/4)	Ø31.75 (Ø1-1/4)	Ø31.75 (Ø1-1/4)	Ø31.75 (Ø1-1/4)	
	Liquid pipe	mm (inches)	Ø19.05 (Ø3/4)	Ø19.05 (Ø3/4)	Ø19.05 (Ø3/4)	Ø19.05 (Ø3/4)	Ø19.05 (Ø3/4)	Ø19.05 (Ø3/4)	Ø19.05 (Ø3/4)	Ø19.05 (Ø3/4)	Ø19.05 (Ø3/4)	Ø19.05 (Ø3/4)	Ø19.05 (Ø3/4)	
	Balance pipe	mm (inches)	Ø6.35 (Ø1/4)	Ø6.35 (Ø1/4)	Ø6.35 (Ø1/4)	Ø6.35 (Ø1/4)	Ø6.35 (Ø1/4)	Ø6.35 (Ø1/4)	Ø6.35 (Ø1/4)	Ø6.35 (Ø1/4)	Ø6.35 (Ø1/4)	Ø6.35 (Ø1/4)	Ø6.35 (Ø1/4)	
Ambient temperature operating range			Cooling/Dry: -10°C~+52°C (DB). Heating: -20°C~+18°C (WB) Simultaneous operation: -10°C~+24°C (DB)											
Sound pressure level	Normal mode	dB (A)	64.5	64.5	65.0	64.0	64.5	65.0	65.5	66.0	66.5	66.5	67.0	
	Silent mode	dB (A)	59.5	59.5	60.0	59.0	59.5	60.0	60.5	61.0	61.5	61.5	62.0	

GLOBAL REMARKS	Rated conditions:	Cooling	Heating
	Indoor air temperature	27°C DB / 19°C WB	20°C DB
	Outdoor air temperature	35°C DB	7°C DB / 6°C WB

These specifications are subject to change without notice.
* For mixed heating and cooling operation with an outdoor temperature in excess of 24°C DB, please use 50% or more of the horsepower of the outdoor unit for cooling operation.

System example

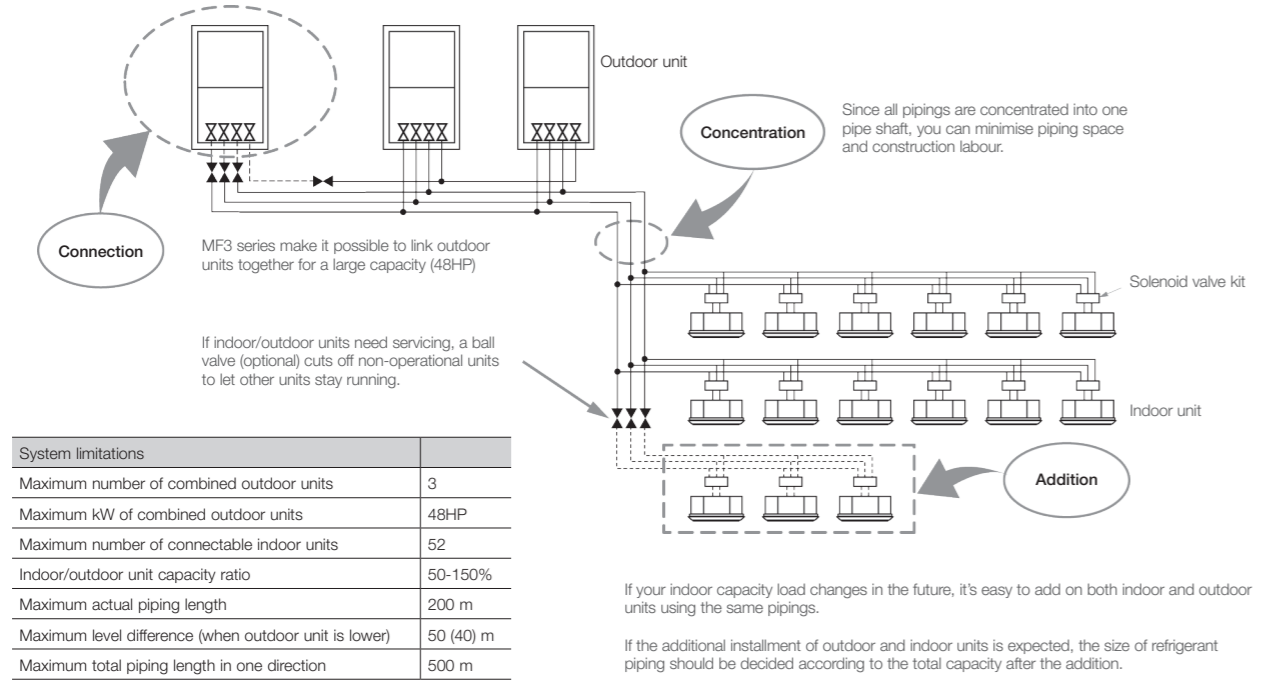

Dimensions

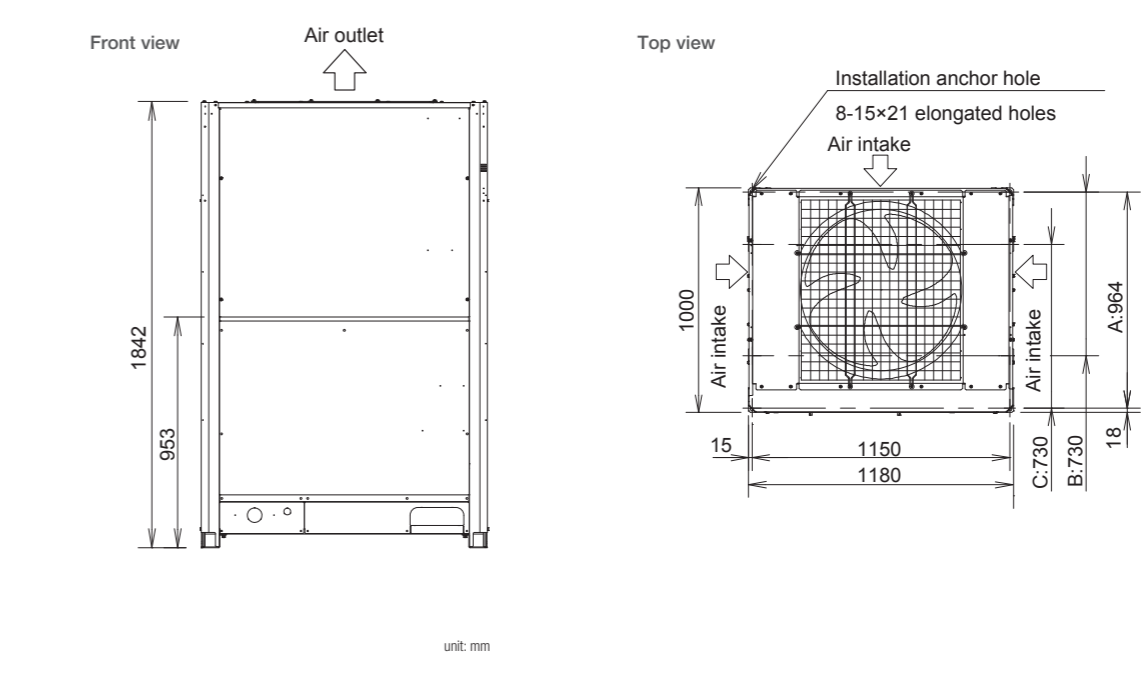

Piping design

Select the installation location so that the length and size of refrigerant tubing are within the allowable range shown in the figure below.

- Main tubing length (maximum tubing size) $LM = LA + LB \dots$
- Main distribution tubes LC – LH are selected according to the capacity after the distribution joint.
- The outdoor connection main tubing (LO portion) is determined by the total capacity of the outdoor units that are connected to the tube ends.
- Sizes of indoor unit connection tubing $\phi 1 - \phi 52$ are determined by the connection tubing sizes on the indoor units.

R410A optional distribution joint
 CZ-P680PH2 (for outdoor unit)
 CZ-P1350PH2 (for outdoor unit)
 CZ-P224BH2 (for indoor unit)
 CZ-P680BH2 (for indoor unit)
 CZ-P1350BH2 (for indoor unit)

Explanation of symbols:
 Distribution joint (CZ: optional parts)
 Ball valve (field supply)
 T-joint (field supply)
 Solidly welded shut (pinch weld)

* Be sure to use special R410A distribution joints (CZ: optional parts) for outdoor unit connections and tubing branches.

Table 2 Ranges that Apply to Refrigerant Tubing Lengths and to Differences in Installation Heights

Ranges that apply to refrigerant piping lengths and to differences in installation heights

Item	Mark	Contents	Length (m)
Allowable tubing length	L1	Max. tubing length	Actual length $\leq 200^{*2}$ Equivalent length $\leq 210^{*2}$
	$\Delta L (L2 - L4)$	Difference between max. length and min. length from the 1st distribution joint	$\leq 50^{*4}$
	LM	Max. length of main tubing (at maximum size) *Even after 1st distribution joint, LM is allowed if at maximum tubing length.	$\leq 50^{*3}$
	$\phi 1, \phi 2 - \phi 52$	Max. length of each distribution tube	$\leq 50^{*5}$
	$L1 + \phi 1 + \phi 2 - \phi 51 + \phi A + \phi B + LF + LG + LH$	Total max. tubing length including length of each distribution tube (only liquid tube)	≤ 500
	$\phi A, \phi B + LO, \phi C + LO$	Maximum tubing length from outdoor's 1st distribution joint to each outdoor unit	≤ 10
	$\phi 1 - 2, \phi 2 - 2 - \phi 52 - 2$	Max. length between solenoid valve kit and indoor unit	≤ 30
Allowable elevation difference	H1	When outdoor unit is installed higher than indoor unit	≤ 50
	H2	When outdoor unit is installed lower than indoor unit	≤ 40
	H3	Max. difference between indoor units	≤ 15
Allowable length of joint tubing	H3	Max. difference between outdoor units	≤ 4
	L3	T-joint tubing (field-supply); Max. tubing length between the first T-joint and solidly welded-shut end point	≤ 2

L = Length, H = Height
 1: The outdoor connection main tubing (LO portion) is determined by the total capacity of the outdoor units that are connected to the tube ends.
 2: If the longest tubing length (L1) exceeds 90 m (equivalent length), increase the sizes of the main tubes (LM) by 1 rank for the suction tubes, discharge tubes and liquid tubes. Use a field supply reducer. Select the tube size from the table of main tubing sizes and from the table of refrigerant tubing sizes.
 3: If the longest main tubing length (LM) exceeds 50 m, increase the main tubing size at the portion before 50 m by 1 rank for the suction tubes and discharge tubes. Use a field supply reducer. Determine the length less than the limitation of allowable maximum tubing length. For the portion that exceeds 50 m, set based on the main tubing size (LA) listed in Table 3.
 4: If the tubing length marked "L" (L2-L4) exceeds 40 m, increase the tubing size at the portion after the 1st distribution joint by 1 rank for the liquid tube, suction tube and discharge tube. Refer to the Technical Data for the details.
 5: If any of the tubing length exceeds 30 m, increase the size of the suction tubes, discharge tubes and liquid tubes by 1 rank. Please refer to the Technical Data for the details.

System limitations

Max. number of combined outdoor units	3
Max. HP of combined outdoor units	135kW(48HP)
Max. number of connectable indoor units	52
Indoor/outdoor unit capacity ratio	50-150%

*1: In the case of 24 HP (type 68.0 kW) or smaller units, the number is limited by the total capacity of the connected indoor units.
 *2: Up to 3 units can be connected if the system has been extended.
 *3: It is strongly recommended that you choose the unit so the load can become between 50 and 130 %.

Additional refrigerant charge

Liquid piping size mm (inches)	Amount of refrigerant charge/m (g/m)
$\phi 6.35 (\phi 1/4)$	26
$\phi 9.52 (\phi 3/8)$	56
$\phi 12.7 (\phi 1/2)$	128
$\phi 15.88 (\phi 5/8)$	185
$\phi 19.05 (\phi 3/4)$	259
$\phi 22.22 (\phi 7/8)$	366

Necessary Amount of Additional Refrigerant Charge per meter, According to Discharge Tubing Size

Discharge tubing size	mm	$\phi 12.7$	$\phi 15.88$	$\phi 19.05$	$\phi 22.22$	$\phi 25.4$	$\phi 28.58$	$\phi 31.75$	$\phi 38.1$
Additional amount	g/m	12	21	31	41	55	71	89	126

*Additional refrigerant charge amount of discharge tubing should be less than 9,000g.

Distribution joint kits

Remarks	Model name	Cooling capacity after distribution
For outdoor unit	1. CZ-P680PH2	24HP or less
	2. CZ-P1350PH2	42HP or less
For indoor unit	3. CZ-P224BH2	8HP or less
	4. CZ-P680BH2	24HP or less
	5. CZ-P1350BH2	42HP or less

Refrigerant piping

Piping size mm (inches)		1/2 H, H material	
Material O	Material H	Outer diameter	Wall thickness
Outer diameter	Wall thickness	Outer diameter	Wall thickness
$\phi 6.35 (\phi 1/4)$	t 0.8 mm	$\phi 22.22 (\phi 7/8)$	t 1.0 mm
$\phi 9.52 (\phi 3/8)$	t 0.8 mm	$\phi 25.4 (\phi 1)$	t 1.0 mm
$\phi 12.7 (\phi 1/2)$	t 0.8 mm	$\phi 28.58 (\phi 1-1/8)$	t 1.0 mm
$\phi 15.88 (\phi 5/8)$	t 1.0 mm	$\phi 31.75 (\phi 1-1/4)$	t 1.1 mm
$\phi 19.05 (\phi 3/4)$	t 1.0 mm	$\phi 38.1 (\phi 1-1/2)$	t 1.15 mm
		$\phi 41.28 (\phi 1-5/8)$	t 1.20 mm

Note: When pipe bending is to be performed, the bending radius shall be at least 4 times the outer diameter. Also, take sufficient care to prevent pipe collapse and damage at the time of bending.

Refrigerant Branch Pipes (optional accessories) for 3-Way MF3 Series

Optional Distribution Joint Kits

See the installation instructions packaged with the distribution joint kit for the installation procedure.

Model name	capacity after distribution JOINT	Remarks
1. CZ-P680PH2	68.0 kW or less	For outdoor unit
2. CZ-P1350PH2	greater than 68.0 kW and no more than 118.0 kW	For outdoor unit
3. CZ-P224BH2	22.4 kW or less	For indoor unit
4. CZ-P680BH2	greater than 22.4 kW and no more than 68.0 kW	For indoor unit
5. CZ-P1350BH2	greater than 68.0 kW and no more than 118.0 kW	For indoor unit

1. CZ-P680PH2

Use: For outdoor unit (Capacity after distribution joint is 68.0 kW or less.)

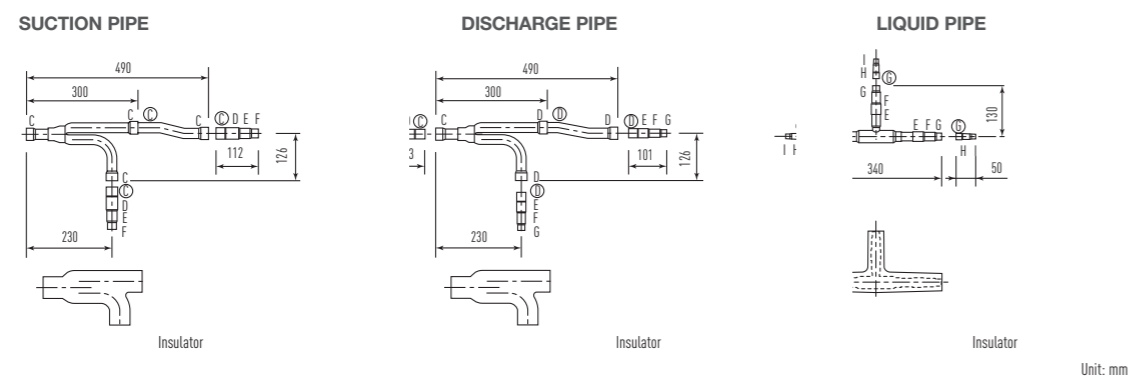

Dimensions for connections of each part										
Position	A	B	C	D	E	F	G	H	I	J
Dimension (mm)	Ø38.10	Ø31.75	Ø28.58	Ø25.40	Ø22.22	Ø19.05	Ø15.88	Ø12.70	Ø9.52	Ø6.35
(inches)	Ø1-1/2	Ø1-1/4	Ø1-1/8	Ø1	Ø7/8	Ø3/4	Ø5/8	Ø1/2	Ø3/8	Ø1/4

2. CZ-P1350PH2

Use: For outdoor unit (Capacity after distribution joint is greater than 68.0 kW and no more than 118.0 kW.)

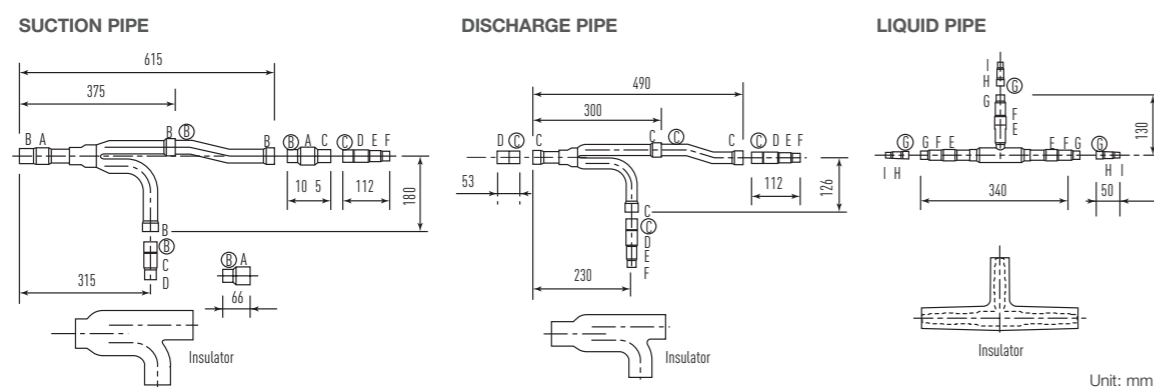

Dimensions for connections of each part										
Position	A	B	C	D	E	F	G	H	I	J
Dimension (mm)	Ø38.10	Ø31.75	Ø28.58	Ø25.40	Ø22.22	Ø19.05	Ø15.88	Ø12.70	Ø9.52	Ø6.35
(inches)	Ø1-1/2	Ø1-1/4	Ø1-1/8	Ø1	Ø7/8	Ø3/4	Ø5/8	Ø1/2	Ø3/8	Ø1/4

Example: [F below indicates inner diameter. (F) below indicates outer diameter.]

3. CZ-P224BH2

Use: For indoor unit (Capacity after distribution joint is 22.4 kW or less.)

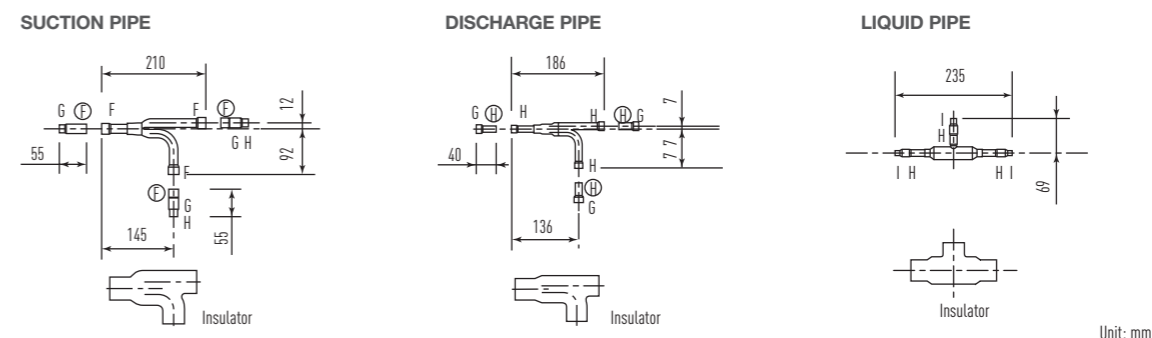

Dimensions for connections of each part										
Position	A	B	C	D	E	F	G	H	I	J
Dimension (mm)	Ø38.10	Ø31.75	Ø28.58	Ø25.40	Ø22.22	Ø19.05	Ø15.88	Ø12.70	Ø9.52	Ø6.35
(inches)	Ø1-1/2	Ø1-1/4	Ø1-1/8	Ø1	Ø7/8	Ø3/4	Ø5/8	Ø1/2	Ø3/8	Ø1/4

4. CZ-P680BH2

Use: For indoor unit (Capacity after distribution joint is greater than 22.4 kW and no more than 68.0 kW.)

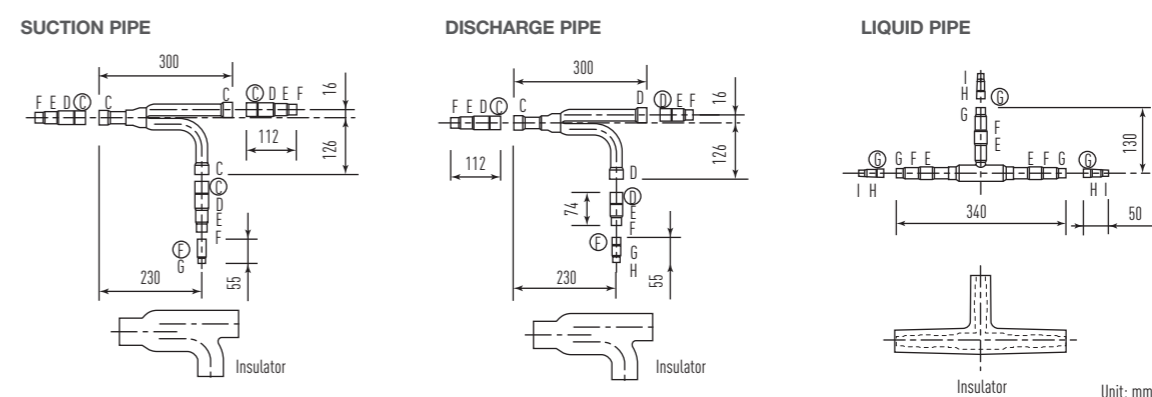

Dimensions for connections of each part										
Position	A	B	C	D	E	F	G	H	I	J
Dimension (mm)	Ø38.10	Ø31.75	Ø28.58	Ø25.40	Ø22.22	Ø19.05	Ø15.88	Ø12.70	Ø9.52	Ø6.35
(inches)	Ø1-1/2	Ø1-1/4	Ø1-1/8	Ø1	Ø7/8	Ø3/4	Ø5/8	Ø1/2	Ø3/8	Ø1/4

5. CZ-P1350BH2

Use: For indoor unit (Capacity after distribution joint is greater than 68.0 kW and no more than 118.0 kW.)

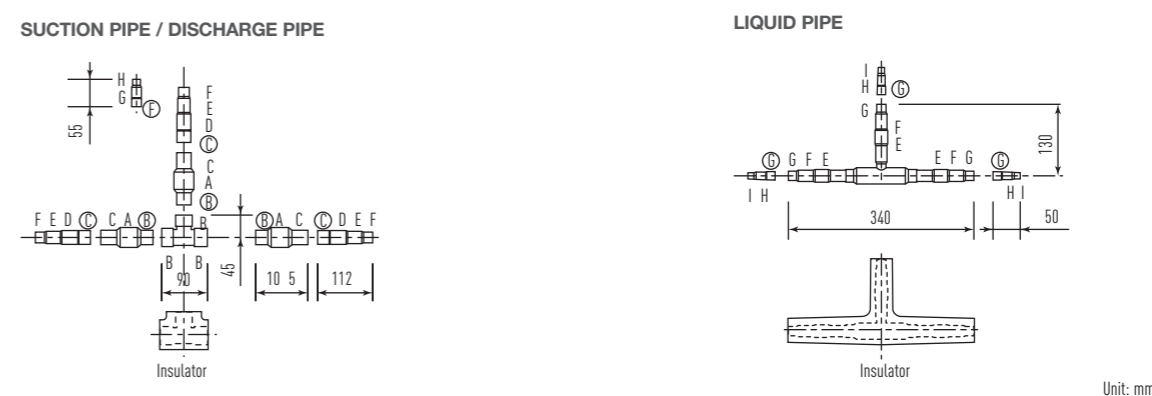

Dimensions for connections of each part										
Position	A	B	C	D	E	F	G	H	I	J
Dimension (mm)	Ø38.10	Ø31.75	Ø28.58	Ø25.40	Ø22.22	Ø19.05	Ø15.88	Ø12.70	Ø9.52	Ø6.35
(inches)	Ø1-1/2	Ø1-1/4	Ø1-1/8	Ø1	Ø7/8	Ø3/4	Ø5/8	Ø1/2	Ø3/8	Ø1/4

2-WAY Mini-FSV LE Series

High External Static Pressure 35Pa

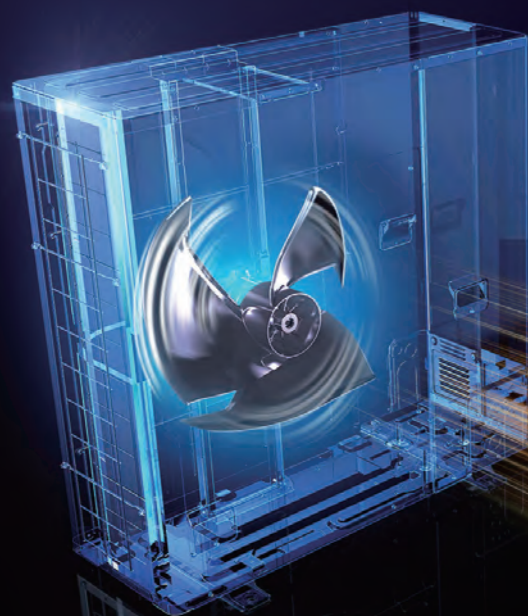

Long piping design length for greater design flexibility

LE1 LE2

Adaptable to various building types and sizes

Actual piping length 150m (equivalent piping length 175m)

Max. total piping length: 300m

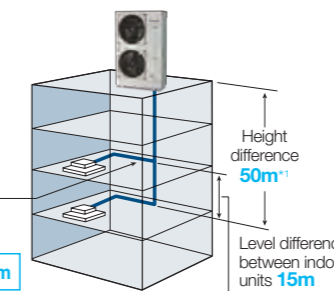

LE 1

Actual piping length 150m (equivalent piping length 175m)

Max. total piping length: 180m

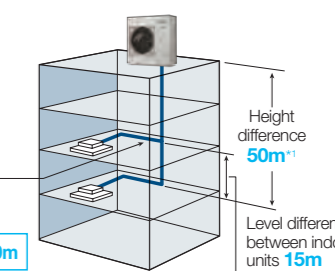

LE 2

*1: 40m if the outdoor unit is below the indoor unit.

Refrigerant chargeless up to 50m

LE2

Up to 50m of piping without additional gas charging makes installation flexible, easy and hassle-free.

A 50m pipe length is sufficient for most residential and small business buildings. When total piping length exceeds 50m, additional refrigerant charge is required.

Chargeless
Max. total piping length: 50m

Charge
Max. total piping length: 180m (Actual length: 150m)

[Sample piping lay-out]

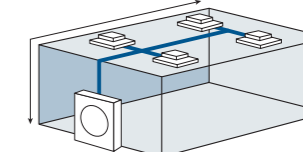

High external static pressure 35Pa

LE1 LE2

When unit is installed on a narrow balcony and exposed to the sun, the fence at the front side would restrict hot air from being discharged. Heat accumulated in an enclosure can cause over-heating. This could potentially result in damage or shorten the product's life span. A high external static pressure sends the air further away from the outdoor unit and through the fence. This provides better air circulation and distribution.



Previous model - Low pressure

When the pressure is low, hot air will accumulate in the unit thus affecting its work performance and of the unit above it as well.

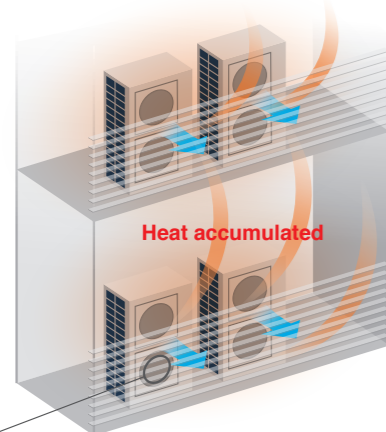

Previous fan

High electrostatic pressure disrupted the airflow of the previous fan, lowering the air pressure and preventing hot air from being discharged far enough.



LE series - High pressure

But with a high pressure of 35Pa, hot air is sent further away preventing overheating inside the outdoor unit enclosure.

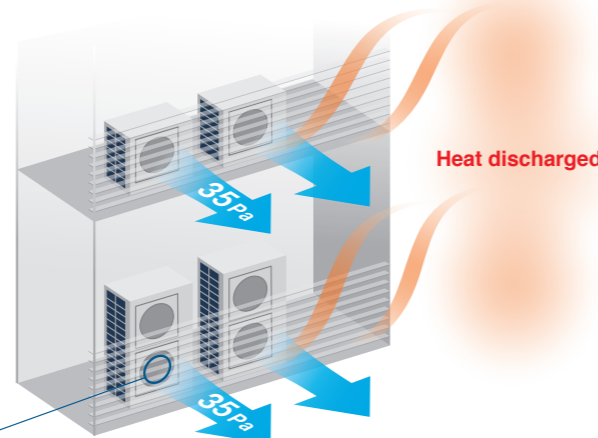

LE series fan

The new LE Series fan has ribs extending near the blade tips, in a structure that resists deformation. During high electrostatic pressure, this blade shape suppresses disruptions in the airflow, and a high air pressure of 35 Pa discharges the hot air a sufficient distance.



Compact design

LE1 LE2

Also, since Mini VRF LE Series is a single unit, it is possible to install the unit in more various places compared to the Single Split system.



Short height of 996mm

LE2

In addition to raising efficiency, we have made the outdoor unit more compact. It can now be installed in places that were previously too small.

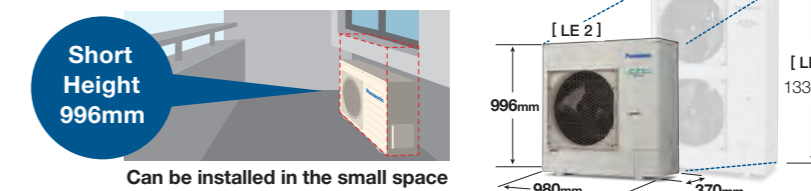

Up to 13 indoor units connectable

LE1 LE2

An expansion from Panasonic VRF line up, the Mini FSV is compatible with the same indoor units and controls as the rest of the FSV range.



* Use any of the 22 type indoor models. Depending on the size or type of indoor unit, tubing size shall be changed. Please refer manuals for details.
* Diversity ration 50-130%
* 6 HP only; 4 HP for 7 units, 5 HP for 8 units.

2-WAY Mini-FSV LE Series

High efficiency

LE1 LE2

The operation efficiency has been improved using highly efficient R410A refrigerant, a DC Inverter compressor, DC motor and a heat exchanger design.

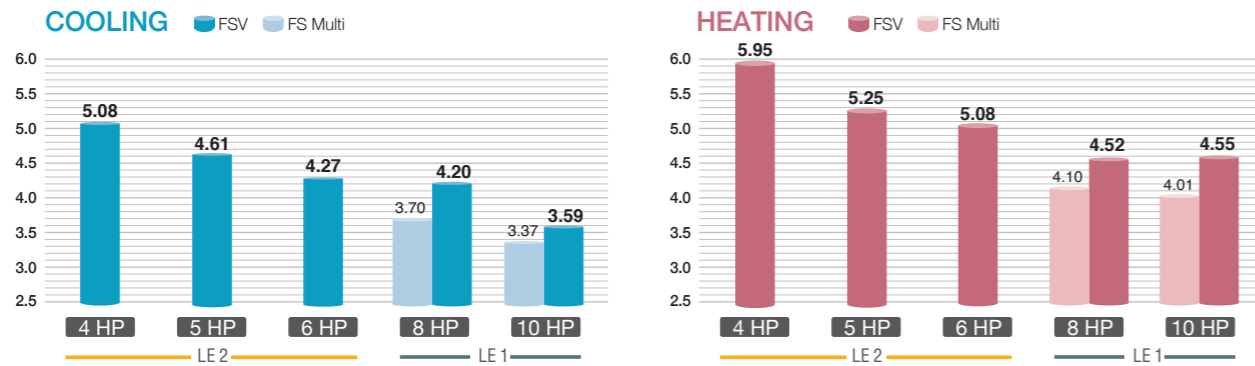

Energy savings design

LE1 LE2

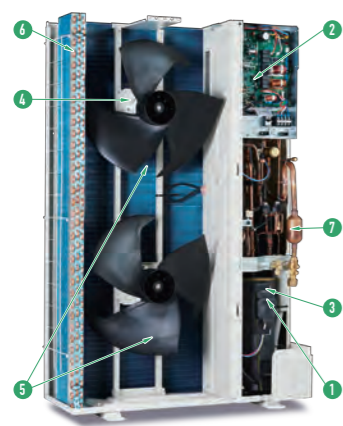

- 1 Panasonic Inverter Compressor** A large-capacity inverter compressor has been adopted. The inverter compressor is superior in performance with improved partial-load capacity.
- 2 Printed Circuit Board** The number of PCB is 2 pieces for making maintenance easier.
- 3 Accumulator** A large accumulator has been adopted to maintain compressor reliability because of the increased refrigerant quantity, which allows an extended max piping length.
- 4 DC Fan Motor** Checking load and outside temperature, the DC motor is controlled for optimum air volume.
- 5 Newly Designed Fan** The newly designed fan blades have been developed to inhibit air turbulence and to increase efficiency. As fan diameter has been increased its size, the air volume has been increased whilst maintaining a same sound level.
- 6 Heat Exchanger & Copper Tubes** The heat exchanger size and the copper tube sizes in the heat exchanger have been redesigned to increase efficiency.
- 7 Oil Separator** A centrifugal separator has been adopted to improve oil separation efficiency and reduce refrigerant pressure loss.

Flexible demand response with the optional terminal block

LE1 LE2

Demand Response

Featuring inverter control technology, all Panasonic Mini FSV systems are Demand Response Management (DRM) ready. With this control, power consumption at times of peak load can be set in three steps to deliver optimum performance. This helps to reduce annual power consumption with minimal loss in comfort.

*Terminal block supplied as optional kit. (CZ-CAPDC3) Please ask you dealer.

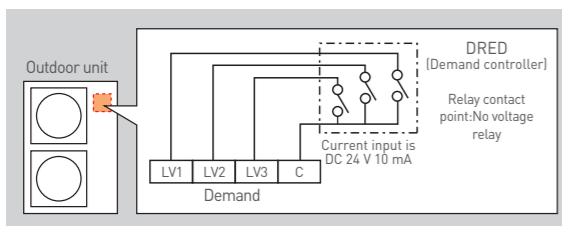

Flexible Demand Response with the CZ-CAPDC2^{*1}

Setting is possible as 0% or in the range from 40 to 100% (in steps of 5%). At the time of shipping, setting has been done to the three steps of 0%, 70% and 100%.

^{*1} An outdoor Seri-Para I/O unit (CZ-CAPDC2) is required for demand input signal.
^{*} Demand timer setting for high spec remote controller is available.

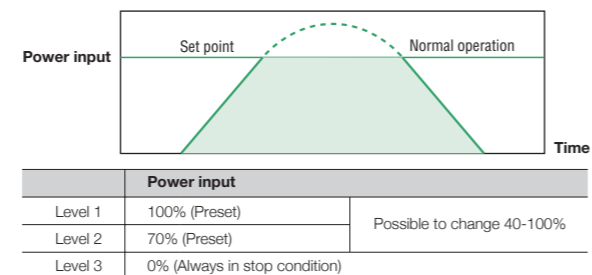

Wide operating range

LE1 LE2

- Cooling operation is possible even when outdoor temperature is as low as -10°C DB.
- Cooling operation is possible even when outdoor temperature is as high as 46°C DB.
- Heating operation is possible even when outdoor temperature is as low as -20°C WB.

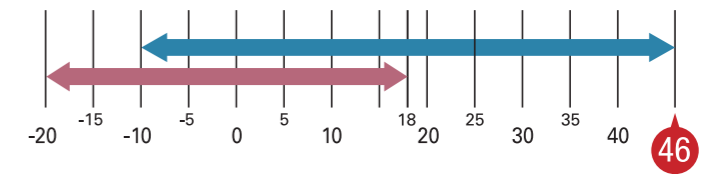

■ Cooling: -10°C DB ~ 46°C DB ■ Heating: -20°C WB ~ 18°C WB
^{*} For further information please refer to the capacity tables in the Technical Data Book.

The remote controller temperature can be set from 18°C up to 30°C (Cooling), 16°C up to 30°C (Heating)^{*1}.

^{*1} Depending on the type of remote controller.

Blue fin condenser

LE1 LE2

The anti-corrosion Blue Fin treatment of the heat exchanger provides greater resistance against corrosion. All models are equipped with Blue Fin condenser.

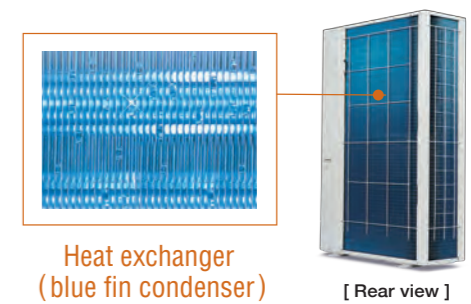

High durability outdoor unit

LE1 LE2

Corrosion-resistance treated for high resistance to rust and salty air to assure long-lasting performance.

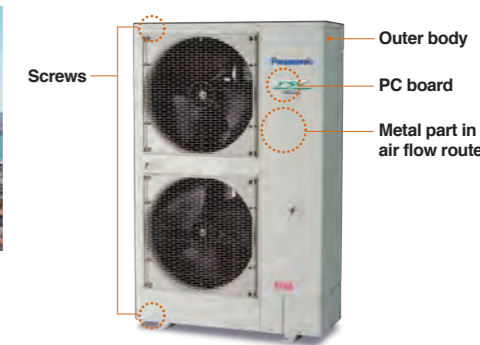

Note: Selecting this unit does not completely eliminate the possibility of rust developing. For details concerning unit installation and maintenance, please consult an authorised dealer.

^{*} Specific model with suffix "E" has this treatment.

Quiet operation mode

LE1 LE2

- Quiet operation mode reduces outdoor unit operating sound down to 7dB than rating.
- 3-step set point is available.
- External input signal is also available.

^{*} Timer setting of quiet operation mode is available in High-spec Remote Controller (CZ-RTC5B/CZ-RTC6 series).



2-WAY Mini-FSV LE2 Series

HP	4			4			5			5			6			6					
Model name	U-4LE2H4			U-4LE2H7			U-5LE2H4			U-5LE2H7			U-6LE2H4			U-6LE2H7					
Power supply	220/230/240V/ 1-phase/50Hz 220/230V/1-phase/60Hz			380/400/415V/ 3-phase/50Hz 380/400V/3-phase/60Hz			220/230/240V/ 1-phase/50Hz 220/230V/1-phase/60Hz			380/400/415V/ 3-phase/50Hz 380/400V/3-phase/60Hz			220/230/240V/ 1-phase/50Hz 220/230V/1-phase/60Hz			380/400/415V/ 3-phase/50Hz 380/400V/3-phase/60Hz					
Voltage	220V	230V	240V	380V	400V	415V	220V	230V	240V	380V	400V	415V	220V	230V	240V	380V	400V	415V			
Capacity	Cooling	kW	12.1			12.1			14.0			14.0			15.5			15.5			
		BTU/h	41,300			41,300			47,800			47,800			52,900			52,900			
Capacity	Heating	kW	12.5			12.5			16.0			16.0			16.5			16.5			
		BTU/h	42,700			42,700			54,600			54,600			56,300			56,300			
EER/COP	Cooling	W/W	5.08			5.08			4.61			4.61			4.27			4.27			
		W/W	5.95			5.95			5.25			5.25			5.08			5.08			
Dimensions	H x W x D	mm	996 x 980 x 370			996 x 980 x 370			996 x 980 x 370			996 x 980 x 370			996 x 980 x 370			996 x 980 x 370			
		kg	106			106			106			106			106			106			
Electrical ratings	Cooling	Running current	A	11.90	11.40	10.90	3.89	3.69	3.56	15.20	14.50	13.90	4.91	4.67	4.50	18.10	17.30	16.60	5.87	5.57	5.37
		Power input	kW	2.38	2.38	2.38	2.38	2.38	3.04	3.04	3.04	3.04	3.04	3.63	3.63	3.63	3.63	3.63	3.63	3.63	3.63
	Heating	Running current	A	10.60	10.10	9.70	3.47	3.29	3.18	15.20	14.60	14.0	4.93	4.68	4.51	16.20	15.50	14.90	5.25	4.99	4.81
		Power input	kW	2.10	2.10	2.10	2.10	2.10	3.05	3.05	3.05	3.05	3.05	3.05	3.05	3.25	3.25	3.25	3.25	3.25	3.25
Starting current	A	1			1			1			1			1			1				
Air flow rate	m ³ / min	69			69			72			72			74			74				
	L/s	1,150			1,150			1,200			1,200			1,233			1,233				
Refrigerant amount at shipment	kg	R410A 6.70			R410A 6.70			R410A 6.70			R410A 6.70			R410A 6.70			R410A 6.70				
Piping connection	Gas pipe	mm (inches)	Ø15.88 (Ø5/8)			Ø15.88 (Ø5/8)			Ø15.88 (Ø5/8)			Ø15.88 (Ø5/8)			Ø15.88 (Ø5/8)			Ø15.88 (Ø5/8)			
	Liquid pipe	mm (inches)	Ø9.52 (Ø3/8)			Ø9.52 (Ø3/8)			Ø9.52 (Ø3/8)			Ø9.52 (Ø3/8)			Ø9.52 (Ø3/8)			Ø9.52 (Ø3/8)			
Ambient temperature operating range	Cooling	-10°CDB~+46°CDB,	-10°CDB~+46°CDB,			-10°CDB~+46°CDB,			-10°CDB~+46°CDB,			-10°CDB~+46°CDB,			-10°CDB~+46°CDB,			-10°CDB~+46°CDB,			
	Heating	-20°CWB~+18°CWB	-20°CWB~+18°CWB			-20°CWB~+18°CWB			-20°CWB~+18°CWB			-20°CWB~+18°CWB			-20°CWB~+18°CWB			-20°CWB~+18°CWB			
Sound pressure level (Cooling)	Normal mode	dB(A)	52.0			52.0			53.0			53.0			54.0			54.0			
	Silent mode (3)	dB(A)	45.0			45.0			46.0			46.0			47.0			47.0			
Sound power level (Cooling)	Normal mode	dB	69.0			69.0			71.0			71.0			73.0			73.0			

Global remarks	Rated conditions:	
	Cooling	Heating
	Indoor air temperature 27°C DB / 19°C WB	20°C DB
	Outdoor air temperature 35°C DB	7°C DB / 6°C WB

These specifications are subject to change without notice.
High durable model (with suffix "E") has same specifications.

2-WAY Mini-FSV LE1 Series

HP	8			10					
Model name	U-8LE1H7			U-10LE1H7					
Power supply	380/400/415V/3-phase/50Hz 380/400V/3-phase/60Hz			380/400/415V/3-phase/50Hz 380/400V/3-phase/60Hz					
Voltage	380V	400V	415V	380V	400V	415V			
Capacity	Cooling	kW	22.4			28.0			
		BTU/h	76,500			95,600			
Capacity	Heating	kW	25.0			28.0			
		BTU/h	85,300			95,600			
EER/COP	Cooling	W/W	4.20			3.59			
		W/W	4.52			4.55			
Dimensions	H x W x D	mm	1,500 x 980 x 370			1,500 x 980 x 370			
Net weight	kg	132			133				
Electrical ratings	Cooling	Running current	A	8.70	8.25	7.95	12.7	12.1	11.7
		Power input	kW	5.33	5.33	5.33	7.80	7.80	7.80
	Heating	Running current	A	9.05	8.60	8.25	10.0	9.55	9.20
		Power input	kW	5.53	5.53	5.53	6.15	6.15	6.15
Starting current	A	1			1				
Air flow rate	m ³ / min	150			160				
	L/s	2,500			2,667				
Refrigerant amount at shipment	kg	R410A 6.30			R410A 6.60				
Piping connection	Gas pipe	mm (inches)	Ø19.05 (Ø3/4)			Ø22.22 (Ø7/8)			
	Liquid pipe	mm (inches)	Ø9.52 (Ø3/8)			Ø9.52 (Ø3/8)			
Ambient temperature operating range	Cooling	-10°CDB~+46°CDB,	-10°CDB~+46°CDB,			-10°CDB~+46°CDB,			
	Heating	-20°CWB~+18°CWB	-20°CWB~+18°CWB			-20°CWB~+18°CWB			
Sound pressure level (Cooling)	Normal mode	dB(A)	59.0			62.0			
	Silent mode (3)	dB(A)	52.0			55.0			
Sound power level (Cooling)	Normal mode	dB	80.0			83.0			

Global remarks	Rated conditions:	
	Cooling	Heating
	Indoor air temperature 27°C DB / 19°C WB	20°C DB
	Outdoor air temperature 35°C DB	7°C DB / 6°C WB

These specifications are subject to change without notice.
High durable model (with suffix "E") has same specifications.

Dimensions

U-4LE2H4 / U-4LE2H7
U-5LE2H4 / U-5LE2H7
U-6LE2H4 / U-6LE2H7

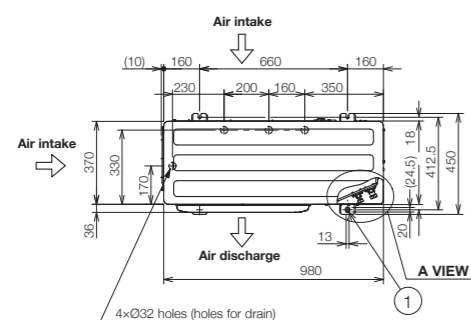

- ① Mounting hole (4-R6.5), anchor bolt : M10
- ② Refrigerant tubing (liquid tube), flared connection (Ø9.52)
- ③ Refrigerant tubing (gas tube), flared connection (Ø15.88)
- ④ Refrigerant tubing port
- ⑤ Electrical wiring port (Ø13)
- ⑥ Electrical wiring port (Ø22)
- ⑦ Electrical wiring port (Ø27)
- ⑧ Electrical wiring port (Ø35)

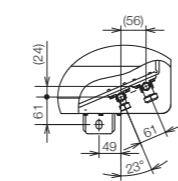

A VIEW

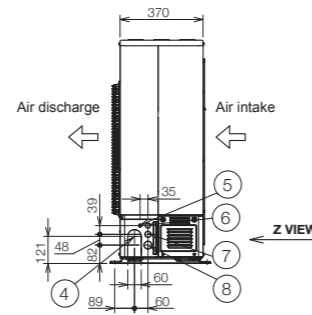
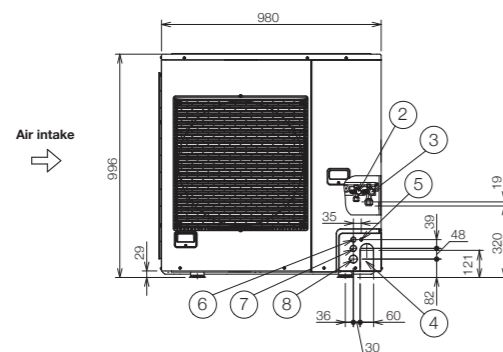

Z VIEW

Unit: mm

Dimensions

U-8LE1H7 / U-10LE1H7

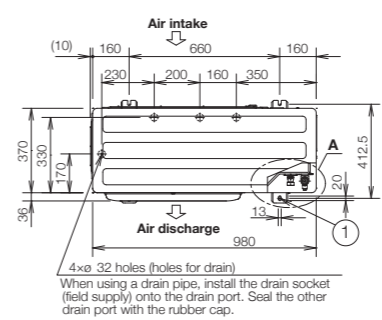

- ① Mounting hole (4-R6.5), anchor bolt : M10
- ② Refrigerant tubing (liquid tube), flared connection (Ø9.52) for 8-10 HP finally.
- ③ Refrigerant tubing (gas tube), flared connection (Ø19.05)
- ④ Refrigerant tubing port
- ⑤ Electrical wiring port (Ø13)
- ⑥ Electrical wiring port (Ø22)
- ⑦ Electrical wiring port (Ø27)
- ⑧ Electrical wiring port (Ø35)

For U-10LE1H7
The tubing of the gas main has a diameter of ø22.22, but the connection to the service valve of the outdoor unit has a diameter of ø19.05, so a flare has to be used. Consequently, be sure to use the enclosed joint tube B and joint tube A in making connections (brazing).

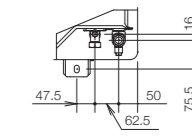

A VIEW

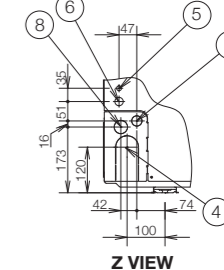
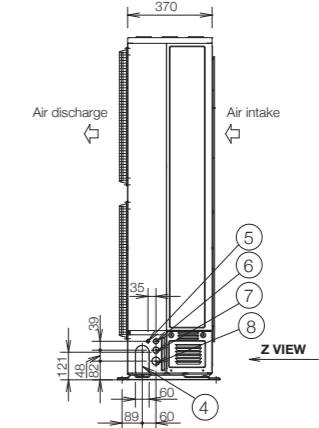
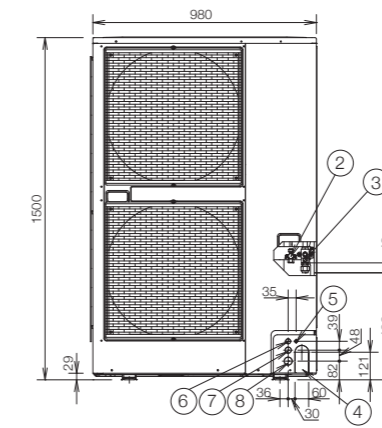

Z VIEW

Unit: mm

Bringing nature's balance indoors

nanoe™ X, technology with the benefits of hydroxyl radicals

The well-being benefits of nature are well known - but do you know the power of hydroxyl radicals?

Abundant in nature, hydroxyl radicals (also known as OH radicals) inhibit pollutants, viruses and bacteria to clean and deodorise. nanoe™ X technology brings these incredible benefits indoors by containing hydroxyl radicals in water, so that hard surfaces, soft furnishings and the indoor environment can be a clean and pleasant place to be, whether at home, at work, or visiting hotels, shops, restaurants etc.

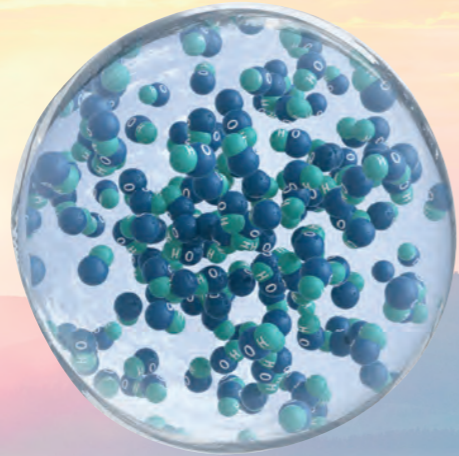

Hydroxyl radicals contained in water

A naturally occurring process

Hydroxyl radicals are unstable molecules looking to react with other elements like hydrogen molecules of pollutants, capturing it. Thanks to this reaction, hydroxyl radicals inhibit the growth of pollutants such as viruses, bacteria, moulds, and odours, breaking them down and neutralising the unpleasant effects. This naturally occurring process has major benefits to improve indoor environments.

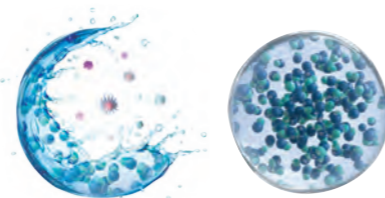

Bringing nature's balance indoors nanoe™ X, technology with the benefits of hydroxyl radicals

nanoe™ X, technology with the benefits of hydroxyl radicals

Panasonic's nanoe™ X technology takes a step further and brings nature's detergent - hydroxyl radicals - indoors to help create an ideal environment.

By creating hydroxyl radicals contained in water, nanoe™ X technology significantly boosts their effectiveness, increasing hydroxyl radicals lifetime from less than a second in nature, to more than 600 seconds – 10 minutes.

<https://www.panasonic.com/global/consumer/clean/hydroxyl/technology.html>

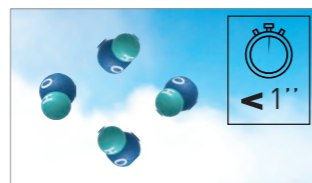

Hydroxyl radicals in nature

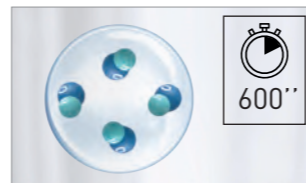

Hydroxyl radicals contained in water - nanoe™ X

Effectiveness of nanoe™ X

nanoe™ X deodorises, inhibits bacteria & viruses, mould, allergens, pollen and hazardous substances, as well as moisturising the whole room for smoother skin and hair.

Deodorises



Odours

Inhibits 5 types of pollutants



Bacteria & viruses



Mould



Allergens



Pollen



Hazardous substances

Moisturises



Skin & Hair

For further details and validation data, please refer to the following website:

https://aircon.panasonic.com/introducing/whats_nanoe/nanoeX.html



Thanks to the nanoe™ X properties, several types of pollutants can be inhibited.

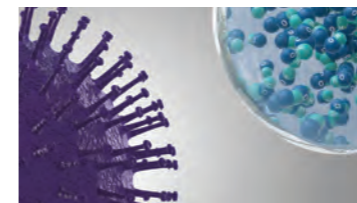

nanoe™ X reliably reaches pollutants.

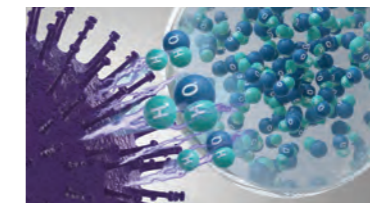

Hydroxyl radicals transform pollutants' proteins.

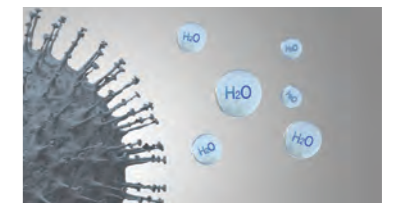

Pollutants activity is inhibited.

Effective on Adhered Pollutants

Nano-sized (5-20 nm) nanoe™ X penetrates deep into fabrics and deodorises, inhibits bacteria, viruses, mould, allergens, pollen and hazardous substances.

nanoe™ X extensively spread out through the room to inhibit adhered pollutants adhering to surfaces, while airfilters only collect airborne dust but adhered substances.

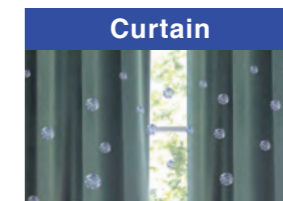
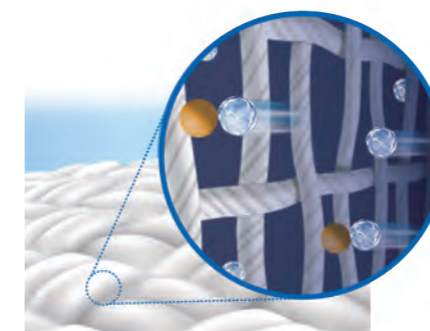

Curtain

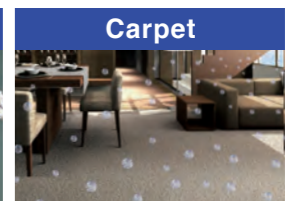

Carpet

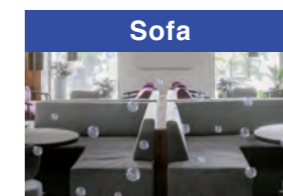

Sofa



Cloth surface

24-hour nanoe™ X Air Purification*

While the general filters in air purifiers are effective against airborne bacteria and viruses, nanoe™ X also works to inhibit longer-living, adhered bacteria and viruses. As well as this, the Panasonic Comfort Cloud and WLAN smart adaptor (CZ-CAPWFC1) gives you access to your air conditioner anywhere, anytime, so you can turn nanoe™ X on even while you're out and enjoy 24-hour quality air.



*Unit must be constantly turned on and operating in the air purification mode - nanoe™ X.
** <https://www.businessinsider.com/coronavirus-lifespan-on-surfaces-graphic-2020-3>

24-hour nanoe™ X air Purification, anywhere, anytime

Actively purifies your air and inhibits pollutants all day long

Get 24 hr Quality Air for you and your loved ones by turning nanoe™ X on using Panasonic Comfort Cloud even when you're out. nanoe™ X functions in both cooling and heating modes and is maintenance-free, helping you keep your costs down with cleaner air.

- nanoe™ X functions in cooling as well as fan mode after business hours.
- Cleans indoor air even when the space is not in use.
- No need to consume excessive electricity to clean the air.



Please refer to the nanoe™ X website.

nanoe™ X cleans indoor air while maintaining a comfortable temperature when people are present.

After business hours, nanoe™ X keeps cleaning indoor air in fan mode.

*In case of using 2.2 kW-7.3 kW 4 way cassette models with fan tap L, flap position 5, standard panel. Energy consumption may vary depending on models.

nanoe™ X device evolution

	nanoe™	nanoe™ X Generator Mark 1	nanoe™ X Generator Mark 2	nanoe™ X Generator Mark 3	Differences in discharge systems Changed from 4-point discharge to circular discharge
Evolved Discharge System					
Higher Concentration of nanoe™ X in the Space					
Hydroxyl radicals					<p>10x times → 20x times → 100x times</p>
	0.48 Trillion* hydroxyl radicals/sec	4.8 Trillion* hydroxyl radicals/sec	9.6 Trillion* hydroxyl radicals/sec	48 Trillion* hydroxyl radicals/sec	
Device status					<p>Electrostatic atomisation Multi-leader discharge</p> <p>Electrostatic atomisation Circular discharge</p>

* Measured using the ESR (Electron Spin Resonance) method (amount of hydroxyl radicals immediately after release from the generator). (Source: Panasonic internal research)

nanoe™ X technology inhibits novel coronavirus

Our nanoe™ X technology has shown to suppress the activity of viruses & bacteria. Enjoy cleaner and quality air at home. Stay safer indoors with nanoe™ X.

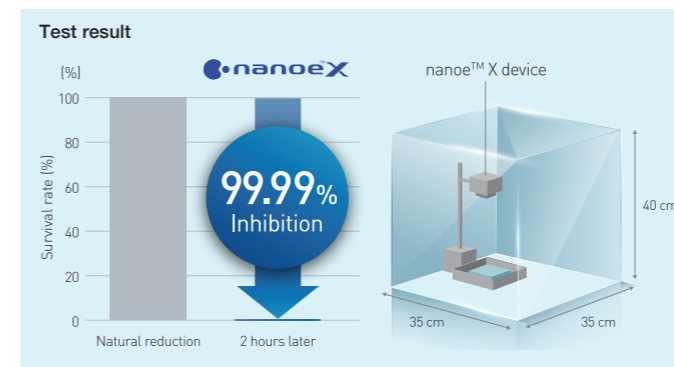

Overview

The objective of this test was to determine if nanoe™ X inhibit the activity of the SARS-CoV-2 virus. Gauze saturated with SARS-CoV-2 virus solution was exposed to a generator of nanoe™ X from a distance of 15 cm in a 45-liter box for 2 hours. Over 99.99%* of the activity of the SARS-CoV-2 virus was inhibited.

Device type: 10 x nanoe™ X (Mark 1)
Subject: Novel coronavirus (SARS-CoV-2)
Test Institute: TEXCELL (France) Test duration: 2 hours

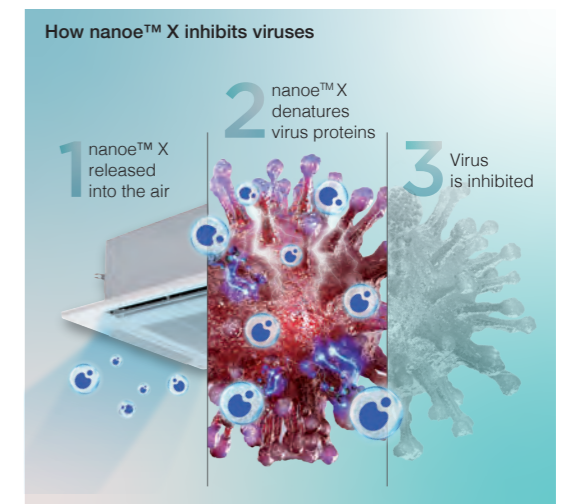

Notes: 1) The virus infectious titer was measured and used to calculate the inhibition rate. 2) This verification was designed to generate basic research data on the effects of nanoe™ X on the novel coronavirus in laboratory conditions. It was not designed to evaluate product performance.

nanoe™ X Mark 3 achieves virus inhibition in a larger space in a shorter time

Mark 3 (100 x) Device: 4-Way Cassette Large-Space Test for Adherent Virus (Bacteriophage)
In a large space of 139 m³ (56 m²), a 98.81% inhibition rate was achieved in 4 hours.

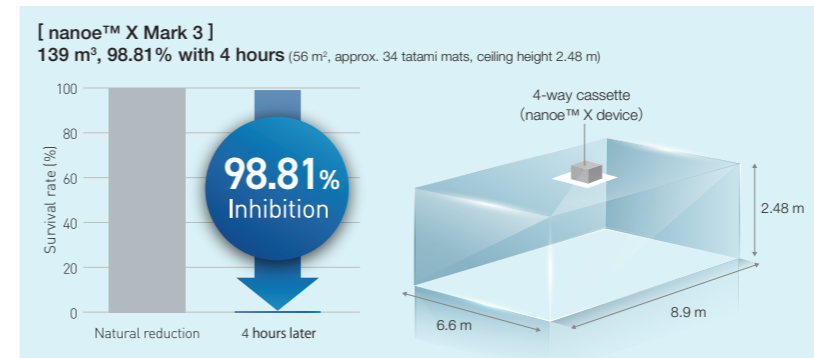

Please refer to the nanoe™ X website for the Mark 3 information.

Device type: nanoe™ X Generator Mark 3
Subject: Adhesive virus (coliphage)
Indoor unit: 4-way cassette
Test Institute: SGS Inc
Test duration: 4 hours
Report No.: SHES210901902584

Smart comfort with CONEX

CONEX goes beyond simple remote control to combine sophistication with simplicity, offering IoT integration that connects directly to a variety of apps for next-generation solutions.

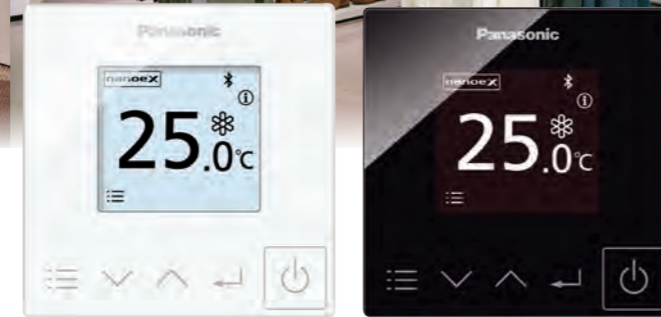

(CZ-RTC6W/CZ-RTC6WBL)

(CZ-RTC6/CZ-RTC6BL)

CONEX

Simple and sophisticated design in-and-out

User friendly interface with stylish design measuring just 86 x 86 mm, CONEX is an extremely compact remote controller which perfectly matches with all kinds of modern building.

Easy control and access for end users and installers with just one remote

User-friendly day to-day operation for end users and simplified set up for installers.



A next-generation remote control solution optimised for usability

H&C Control App
End user > Installer

- Easy setting of timers and scheduling as well as monitoring power consumption.
- Fine tune the equipment to the environment.



Scan QR code to download free Panasonic H&C Control App



(CZ-RTC6WBL/CZ-RTC6BL)

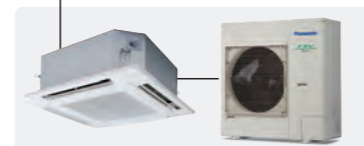

True-comfort for end user and installer – H&C Control App

H&C Control App makes complex initial set-up visually touch and feel easy and respond swiftly to clients' requests via Bluetooth using a smartphone or tablet.

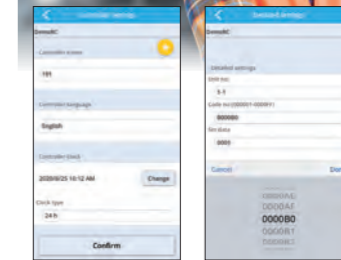

Advantages

Comfort day-to-day operations

It's now simpler than ever for end users to further customize settings to meet their needs and perform operations including basic settings.

Intuitive operation for easy configuration

Simplifies initial controller configuration as well as access to comprehensive settings including weekly timers and maintenance.

Straightforward suggestions to clients

Share a single screen with your customer and together tailor everything to meet their needs, from basic setup to weekly timers, all in real time.

Quicker configuration for multiple controllers

Save time and copy templates for weekly timers and settings to multiple remote controllers.

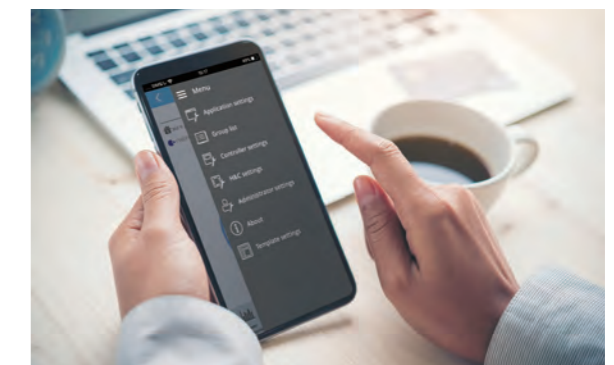

Indoor Units

Wide choice of models depending on the indoor requirements

Key Indoor Units Equipped DC motors



ECONAVI sensor



Providing outstanding energy-saving performance, Panasonic's inverter VRF System can be connected to ECONAVI to detect when energy is being wasted. ECONAVI senses the presence or absence of people and the level of activity in each area of an office. When unnecessary heating or cooling is detected, indoor units are individually controlled to match office conditions for energy-saving operation.



ECONAVI Sensor CZ-CENSC1

Detection of the level of activity enables optimum power saving

Activity or absence of people at their desks and the level of activity in the office are detected in real time. Cooling or heating is automatically adjusted for optimum operation required to lower power consumption.

Sensor is remotely located to maximize the energy saving effect

Pillars, walls, cabinets and other fittings obstruct the sensors, reducing the area of detection and lowering the energy-saving effect. Taking into consideration blind spots, Panasonic enables the optimum layout for sensors in any office.

High-spec wired remote controller



CZ-RTC5B

Large 3.5" full-dot LCD with white LED backlight

Characters and icons are clearly displayed for improved visibility. The display is also large enough to provide a wide range of information for easy confirmation of operation conditions.

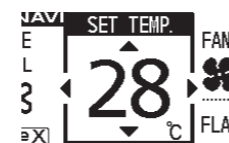

Stylish, easy-to-use touch key design

The elegant, flat design features large touch keys in a simple layout enabling easy, intuitive operation.



All ducted series

Discharge air temperature control

Smart sensors control discharge air temperature for precise room temperature control. Possible to reduce cold drafts during heating operation.

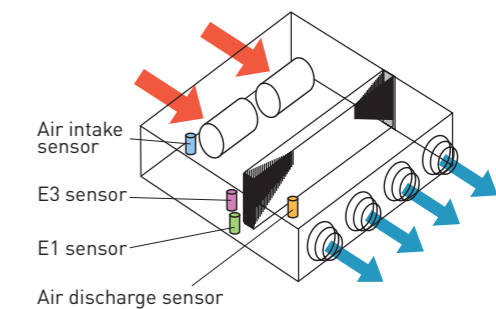

Wall mounted / K2 type



Compact design with flat surface enables seamless match with any type of room interior

Noise reducing external valve kit

To reduce noise level of expansion valve. (Optional accessory)



CZ-P56SVK2 (for 22 - 56 type)
CZ-P160SVK2 (for 73* - 106 type)

*When the pipe diameter is (Liquid) Ø6.35- (Gas) Ø12.7, please use CZ-P56SVK2.

Remote temperature sensor



CZ-CSRC3

- This is a remote sensor which can be used with indoor units. Use it to detect the room temperature when no remote controller sensor or body sensor is used (connection to a system without a remote controller is possible).
- For joint use with a remote control switch, use the remote control switch as main remote controller.

FSV Indoor Units Range

Wide choice of models depending on the indoor requirements

Class	22	28	36	45	56	60	73	90
Capacity	Cooling/Heating	Cooling/Heating	Cooling/Heating	Cooling/Heating	Cooling/Heating	Cooling/Heating	Cooling/Heating	Cooling/Heating
Type	2.2/2.5 7,500/8,500	2.8/3.2 9,600/10,900	3.6/4.2 12,300/14,300	4.5/5.0 15,400/17,100	5.6/6.3 19,100/21,500	6.0/7.1 20,500/24,200	7.3/8.0 24,900/27,300	9.0/10.0 30,700/34,100
nanoeX Generator Mark3	NEW	NEW	NEW	NEW	NEW	NEW	NEW	NEW
F3 type ECONAVI Mid Static Adaptive Ducted	S-22MF3E5AN	S-28MF3E5AN	S-36MF3E5AN	S-45MF3E5AN	S-56MF3E5AN	S-60MF3E5AN	S-73MF3E5AN	S-90MF3E5AN
nanoeX Generator Mark2								
F3 type ECONAVI Mid Static Adaptive Ducted	S-22MF3E5A	S-28MF3E5A	S-36MF3E5A	S-45MF3E5A	S-56MF3E5A	S-60MF3E5A	S-73MF3E5A	S-90MF3E5A
F2 type ECONAVI Mid Static Ducted	S-22MF2E5A8	S-28MF2E5A8	S-36MF2E5A8	S-45MF2E5A8	S-56MF2E5A8	S-60MF2E5A8	S-73MF2E5A8	S-90MF2E5A8
M1 type ECONAVI Slim Low Static Ducted	S-22MM1E5A	S-28MM1E5A	S-36MM1E5A	S-45MM1E5A	S-56MM1E5A			
Z1 type ECONAVI Slim Low Static Ducted Twenty Series	S-22MZ1H4A	S-28MZ1H4A	S-36MZ1H4A	S-45MZ1H4A	S-56MZ1H4A	S-60MZ1H4A	S-73MZ1H4A	
E2 type High Static Ducted / Energy Saving High-Fresh Air Ducted								
E1 type High Static Ducted							S-73ME1E5	
K2 type ECONAVI Wall Mounted	S-22MK2E5A	S-28MK2E5A	S-36MK2E5A	S-45MK2E5A	S-56MK2E5A		S-73MK2E5A	
nanoeX Generator Mark3 U2 type ECONAVI** 4-Way Cassette	NEW	NEW	NEW	NEW	NEW	NEW	NEW	NEW
Panel No. CZ-KPU3H / CZ-KPU3A	S-22MU2E5BN	S-28MU2E5BN	S-36MU2E5BN	S-45MU2E5BN	S-56MU2E5BN	S-60MU2E5BN	S-73MU2E5BN	S-90MU2E5BN
nanoeX Generator Mark2 U2 type ECONAVI** 4-Way Cassette								
Panel No. CZ-KPU3H / CZ-KPU3A	S-22MU2E5B	S-28MU2E5B	S-36MU2E5B	S-45MU2E5B	S-56MU2E5B	S-60MU2E5B	S-73MU2E5B	S-90MU2E5B
nanoeX Generator Mark3 Y3 type ECONAVI 4-Way Mini Cassette								
Panel No. CZ-KPY4	S-22MY3E	S-28MY3E	S-36MY3E	S-45MY3E	S-56MY3E			
Y2 type ECONAVI 4-Way Mini Cassette								
Panel No. CZ-KPY3AW	S-22MY2E5A	S-28MY2E5A	S-36MY2E5A	S-45MY2E5A	S-56MY2E5A			
L1 type 2-Way Cassette								
Panel No. CZ-02KPL2 Panel No. CZ-03KPL2 (Only for S-73ML1E5)	S-22ML1E5	S-28ML1E5	S-36ML1E5	S-45ML1E5	S-56ML1E5		S-73ML1E5	
D1 type 1-Way Cassette								
Panel No. CZ-KPD2		S-28MD1E5	S-36MD1E5	S-45MD1E5	S-56MD1E5		S-73MD1E5	
T2 type ECONAVI Ceiling			S-36MT2E5A	S-45MT2E5A	S-56MT2E5A		S-73MT2E5A	
P1 type Floor Standing	S-22MP1E5	S-28MP1E5	S-36MP1E5	S-45MP1E5	S-56MP1E5		S-71MP1E5	
R1 type Concealed Floor Standing	S-22MR1E5	S-28MR1E5	S-36MR1E5	S-45MR1E5	S-56MR1E5		S-71MR1E5	

* High fresh air system is not allowed for 18 kW model. ** Only for CZ-KPU3A

- Self-diagnosis function
- Automatic fan operation
- DRY Dry mode
- Intelligent auto flap control
- Automatic restart function for power failure
- Air swing
- Built-in drain pump
- DC motor

106	112	140	160	180	224	280	Wireless remote control	Functions
Cooling/Heating	Cooling/Heating	Cooling/Heating	Cooling/Heating	Cooling/Heating	Cooling/Heating	Cooling/Heating	Type with built-in sensor	Type with separately installed sensor
10.6/11.4 36,200/38,900	11.2/12.5 38,200/42,700	14.0/16.0 47,800/54,600	16.0/18.0 54,600/61,400	18.0/20.0 61,400/68,200	22.4/25.0 76,400/85,300	28.0/31.5 95,500/107,500		
	NEW	NEW	NEW					
S-106MF3E5A	S-112MF3E5AN	S-140MF3E5AN	S-160MF3E5AN					Self-diagnosis, Auto fan, Dry mode, Auto restart, Drain pump, DC motor
S-106MF2E5A8	S-140MF3E5A	S-160MF3E5A						Self-diagnosis, Auto fan, Dry mode, Auto restart, Drain pump, DC motor
		S-140MF2E5A8	S-160MF2E5A8					Self-diagnosis, Auto fan, Dry mode, Auto restart, Drain pump, DC motor
								Self-diagnosis, Auto fan, Dry mode, Auto restart, Drain pump, DC motor
				S-180ME2E5 *	High Fresh Air S-224ME2E5	High Fresh Air S-280ME2E5		Self-diagnosis, Auto fan, Dry mode, Auto restart, DC motor
S-106ME1E5	S-140ME1E5				S-224ME1E5	S-280ME1E5		Self-diagnosis, Auto fan, Dry mode, Auto restart
S-106MK2E5A								Self-diagnosis, Auto fan, Dry mode, Auto restart, Air swing, DC motor, Auto flap
	NEW	NEW	NEW					Self-diagnosis, Auto fan, Dry mode, Auto restart, Air swing, Drain pump, DC motor, Auto flap
S-106MU2E5B	S-112MU2E5BN	S-140MU2E5BN	S-160MU2E5BN					Self-diagnosis, Auto fan, Dry mode, Auto restart, Air swing, Drain pump, DC motor, Auto flap
		S-140MU2E5B	S-160MU2E5B					Self-diagnosis, Auto fan, Dry mode, Auto restart, Air swing, Drain pump, DC motor, Auto flap
								Self-diagnosis, Auto fan, Dry mode, Auto restart, Air swing, Drain pump, DC motor, Auto flap
								Self-diagnosis, Auto fan, Dry mode, Auto restart, Air swing, Drain pump, DC motor, Auto flap
S-106MT2E5A	S-140MT2E5A							Self-diagnosis, Auto fan, Dry mode, Auto restart, Air swing, DC motor, Auto flap
								Self-diagnosis, Auto fan, Dry mode, Auto restart
								Self-diagnosis, Auto fan, Dry mode, Auto restart

NEW

F3 TYPE Mid Static Adaptive Ducted

Control all aspects of your environment with exceptional performance and quiet operation. Vertical installation flexibility offers the perfect solution when ceiling heights are restricted.



S-22MF3E5AN / S-28MF3E5AN / S-36MF3E5AN
S-45MF3E5AN / S-56MF3E5AN



S-60MF3E5AN / S-73MF3E5AN
S-90MF3E5AN

nanoe™ X
Generator Mark3



Please refer to the nanoe™ X website for the Mark 3 information.



S-112MF3E5AN / S-140MF3E5AN / S-160MF3E5AN

Optional accessory

ECONAVI
ECONAVI ready



CZ-RTC6W
CZ-RTC6WBL
CZ-RTC6WBLW



CZ-RTC6
CZ-RTC6BL
CZ-RTC6BLW



CZ-CENSC1



CZ-RTC5B



CZ-RWS3
Remote controller



CZ-RWRC3
Receiver

Technical focus

- 4 installation possibilities with horizontal and vertical mounting and selectable rear or bottom air inlet
- Space saving 250mm height
- DC fan motor for variable external static pressure control
- Industry-leading horizontal/vertical design
- Powerful 150Pa static pressure in a compact unit.
- Leading-class low sound levels from 20 dB(A)
- Improved drain pan suitable for both horizontal / vertical installation
- nanoe™ X : 100x for CAC (100 times more nanoe™ particle for wide commercial space)
- Accurate temperature control to reduce cold drafts during operation

Variable external static pressure control

Optimal airflow set-up is possible depending on ducting design and conditions.

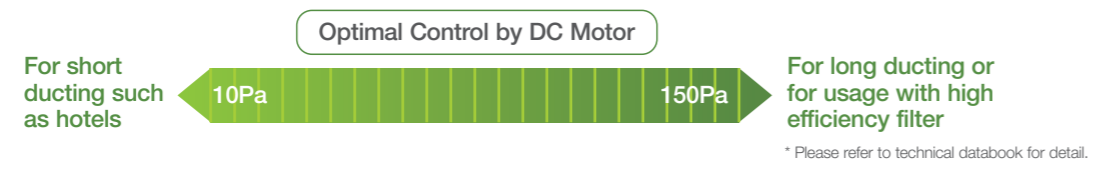

Powerful 150Pa external static pressure in an industry-leading horizontal/vertical installation design

Delivering static pressure up to 150Pa external static pressure, the industry-leading horizontal/vertical design offers the power you need in a compact form factor.

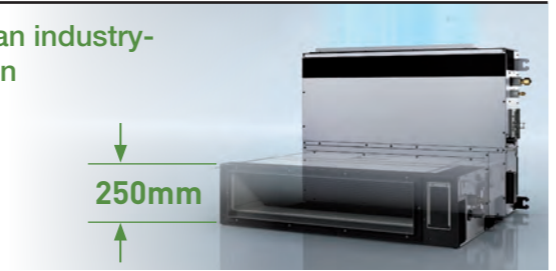

Improved drain pan design

Drain pan is shared in both cases horizontal and vertical installation. No need to alternate anymore.

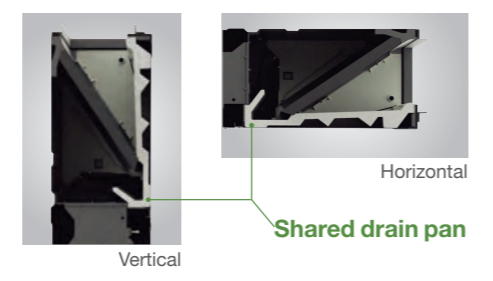

Superior Air Quality

Combined with the strong static pressure this model ensures pristine nanoe™ X air travels unaffected even through multiple duct shapes at lengths of 10m, as well as making them ideal for use in larger spaces.

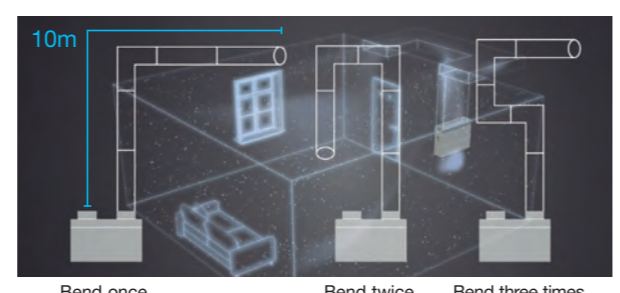

As the experiments demonstrate, even with a total ductwork length of up to 10m, effectiveness of nanoe™ X is maintained.

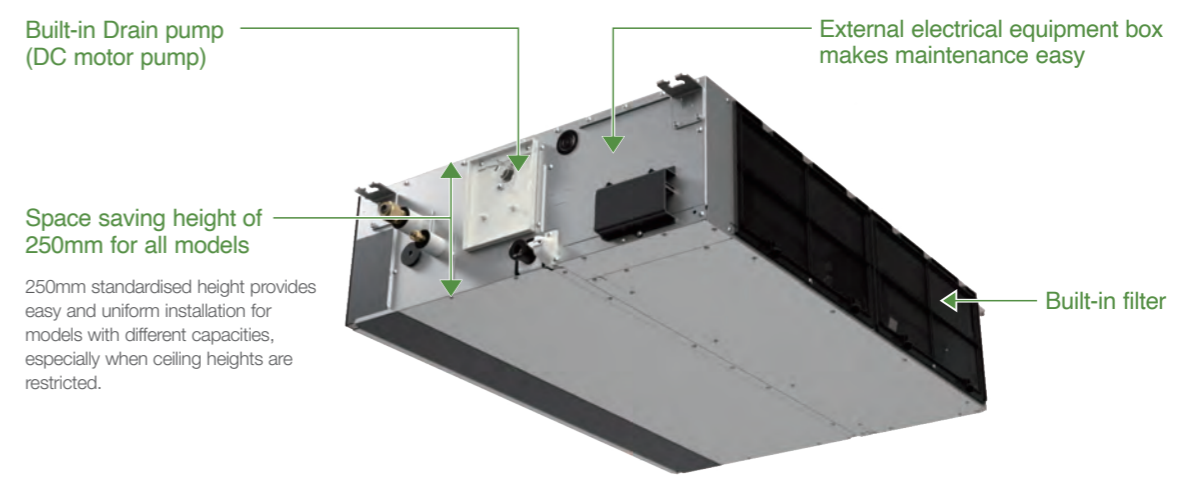

Discharge air temperature control

- Possible to control discharge air temperature for accurate room temperature control.
 - Possible to reduce cold drafts during heating operation.
- Note: Before spec-in, please consult with an authorised Panasonic dealer.

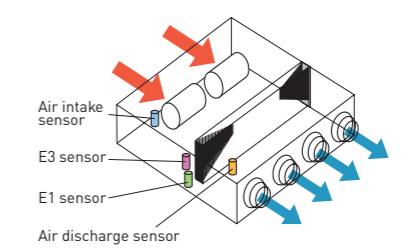

Selectable air inlet position

A removable panel allows air inlet position to be adjusted to enable rear or bottom entry, depending on ductwork installation.

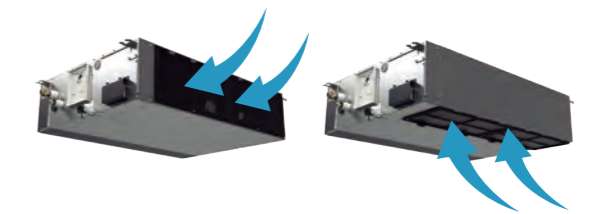

System example

An inspection port (450 mm x 450 mm or larger) is required at the lower side of the indoor unit body.

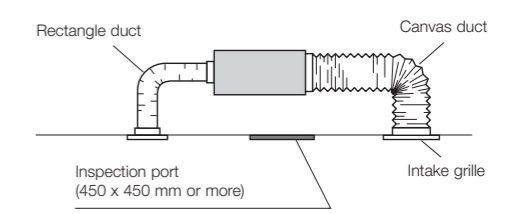

More powerful drain pump

Using a high-lift built-in drain pump, drain piping can be elevated up to 690 mm from the base of the unit.

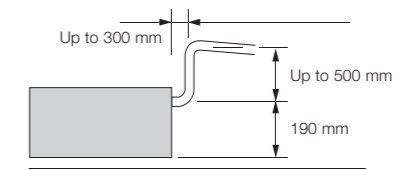

F3 TYPE Mid Static Adaptive Ducted

Model Name	S-22MF3E5AN	S-28MF3E5AN	S-36MF3E5AN	S-45MF3E5AN	S-56MF3E5AN	
Power source	220/230/240 V, 1 phase - 50/60 Hz					
Cooling capacity	kW	2.2	2.8	3.6	4.5	5.6
	BTU/h	7,500	9,600	12,300	15,400	19,100
Heating capacity	kW	2.5	3.2	4.2	5.0	6.3
	BTU/h	8,500	10,900	14,300	17,100	21,500
Power input	Cooling kW	0.06/0.06/0.06	0.06/0.06/0.06	0.06/0.06/0.06	0.06/0.06/0.06	0.089/0.089/0.089
	Heating kW	0.06/0.06/0.06	0.06/0.06/0.06	0.06/0.06/0.06	0.06/0.06/0.06	0.089/0.089/0.089
Running amperes	Cooling A	0.46/0.45/0.44	0.46/0.45/0.44	0.46/0.45/0.44	0.46/0.45/0.44	0.65/0.63/0.61
	Heating A	0.46/0.45/0.44	0.46/0.45/0.44	0.46/0.45/0.44	0.46/0.45/0.44	0.65/0.63/0.61
Fan motor	Type	Sirocco fan	Sirocco fan	Sirocco fan	Sirocco fan	Sirocco fan
	Cooling m³/h	768/660/480	768/660/480	840/720/480	840/720/480	960/840/600
	Air flow rate (H/M/L) L/s	213/183/133	213/183/133	233/200/133	233/200/133	267/233/167
	Heating m³/h	840/720/480	840/720/480	840/720/480	840/720/480	960/840/600
	Air flow rate (H/M/L) L/s	233/200/133	233/200/133	233/200/133	233/200/133	267/233/167
	Output kW	0.107	0.107	0.107	0.107	0.107
	External static pressure Pa	30 (10-150)	30 (10-150)	30 (10-150)	30 (10-150)	30 (10-150)
Sound power level (H/M/L) dB	54/51/43	54/51/43	54/51/43	54/51/43	58/55/47	
Sound pressure sound (H/M/L) dB(A)	31/28/20	31/28/20	31/28/20	31/28/20	35/32/24	
Dimensions H x W x D mm		250 x 800 x 730	250 x 800 x 730	250 x 800 x 730	250 x 800 x 730	250 x 800 x 730
	Liquid mm (inches)	Ø6.35 (Ø1/4)	Ø6.35 (Ø1/4)	Ø6.35 (Ø1/4)	Ø6.35 (Ø1/4)	Ø6.35 (Ø1/4)
Pipe connections Gas mm (inches)		Ø12.7 (Ø1/2)	Ø12.7 (Ø1/2)	Ø12.7 (Ø1/2)	Ø12.7 (Ø1/2)	Ø12.7 (Ø1/2)
	Drain piping	VP-20	VP-20	VP-20	VP-20	VP-20
Net weight kg		26	26	26	26	26

GLOBAL REMARKS	Rated conditions:	
	Cooling	Heating
	Indoor air temperature	27°C DB / 19°C WB
Outdoor air temperature	35°C DB / 24°C WB	7°C DB / 6°C WB

Specifications are subject to change without notice.

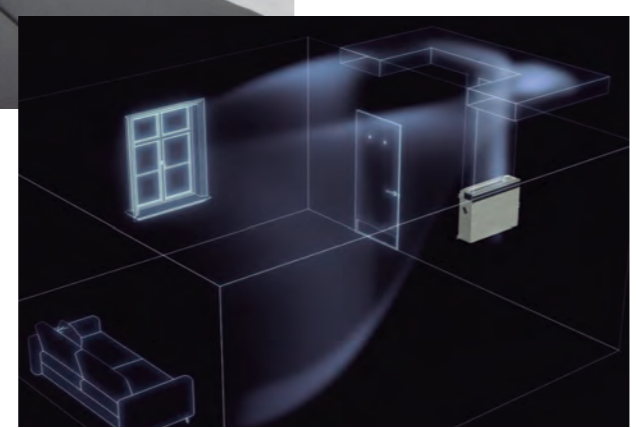

S-60MF3E5AN	S-73MF3E5AN	S-90MF3E5AN	S-112MF3E5AN	S-140MF3E5AN	S-160MF3E5AN
220/230/240 V, 1 phase - 50/60 Hz					
6.0	7.3	9.0	11.2	14.0	16.0
20,500	24,900	30,700	38,200	47,800	54,600
7.1	8.0	10.0	12.5	16.0	18.0
24,200	27,300	34,100	42,700	54,600	61,400
0.079/0.079/0.079	0.079/0.079/0.079	0.136/0.136/0.136	0.265/0.265/0.265	0.265/0.265/0.265	0.330/0.330/0.330
0.079/0.079/0.079	0.079/0.079/0.079	0.136/0.136/0.136	0.265/0.265/0.265	0.265/0.265/0.265	0.330/0.330/0.330
0.53/0.52/0.51	0.53/0.52/0.51	0.92/0.90/0.88	1.80/1.76/1.72	1.80/1.76/1.72	2.22/2.14/2.09
0.53/0.52/0.51	0.53/0.52/0.51	0.92/0.90/0.88	1.80/1.76/1.72	1.80/1.76/1.72	2.22/2.14/2.09
Sirocco fan	Sirocco fan	Sirocco fan	Sirocco fan	Sirocco fan	Sirocco fan
1,260/1,080/900	1,260/1,080/900	1,500/1,380/960	2,220/1,920/1,560	2,220/1,920/1,560	2,400/2,040/1,680
350/300/250	350/300/250	417/383/267	617/533/433	617/533/433	667/567/467
1,260/1,080/900	1,260/1,080/900	1,500/1,380/960	2,220/1,920/1,560	2,220/1,920/1,560	2,400/2,040/1,680
350/300/250	350/300/250	417/383/267	617/533/433	617/533/433	667/567/467
0.165	0.165	0.165	0.259	0.259	0.259
30 (10-150)	30 (10-150)	40 (10-150)	50 (10-150)	50 (10-150)	50 (10-150)
54/51/46	54/51/46	58/56/48	64/59/55	64/59/55	66/60/56
31/28/23	31/28/23	35/33/25	41/36/32	41/36/32	43/37/33
250 x 1,000 x 730	250 x 1,000 x 730	250 x 1,000 x 730	250 x 1,400 x 730	250 x 1,400 x 730	250 x 1,400 x 730
Ø6.35 (Ø1/4)	Ø6.35 (Ø1/4)	Ø6.35 (Ø1/4)	Ø9.52 (Ø3/8)	Ø9.52 (Ø3/8)	Ø9.52 (Ø3/8)
Ø12.7 (Ø1/2)	Ø12.7 (Ø1/2)	Ø12.7 (Ø1/2)	Ø15.88 (Ø5/8)	Ø15.88 (Ø5/8)	Ø15.88 (Ø5/8)
VP-20	VP-20	VP-20	VP-20	VP-20	VP-20
31	31	31	40	40	40

F3 TYPE MID STATIC DUCTED Dimensions

Type	A	B	C	D	E	F	Air intake port size
	mm	mm	mm	mm	mm	Q'ty	mm
22/28/36/45/56	867	800	450 (Pitch 150 x 3)	71	592	12	204 x 683
60/73/90	1,067	1,000	750 (Pitch 150 x 5)	21	792	16	204 x 883
112/140/160	1,467	1,400	1,050 (Pitch 150 x 7)	71	1,192	20	204 x 1,283

- ① Refrigerant tubing joint (liquid tube)
S-22/28/36/45/56MF3E5AN : Φ6.35 (flared)
S-60/73/90/112/140/160MF3E5AN : Φ9.52 (flared)
 - ② Refrigerant tubing joint (gas tube)
S-22/28/36/45/56MF3E5AN : Φ12.7 (flared)
S-60/73/90/112/140/160MF3E5AN : Φ15.88 (flared)
 - ③ Upper drain port VP20 (ø26 mm)
200 mm flexible hose supplied
 - ④ Bottom drain port VP20 (ø26 mm)
 - ⑤ Suspension lug (4 - 12 x 30 mm)
 - ⑥ Power supply outlet
 - ⑦ Fresh air intake port (ø100 mm)*1
 - ⑧ Flange for flexible air outlet duct
 - ⑨ Electrical component box
- *1 Necessary to attach duct connecting flange (field supply).

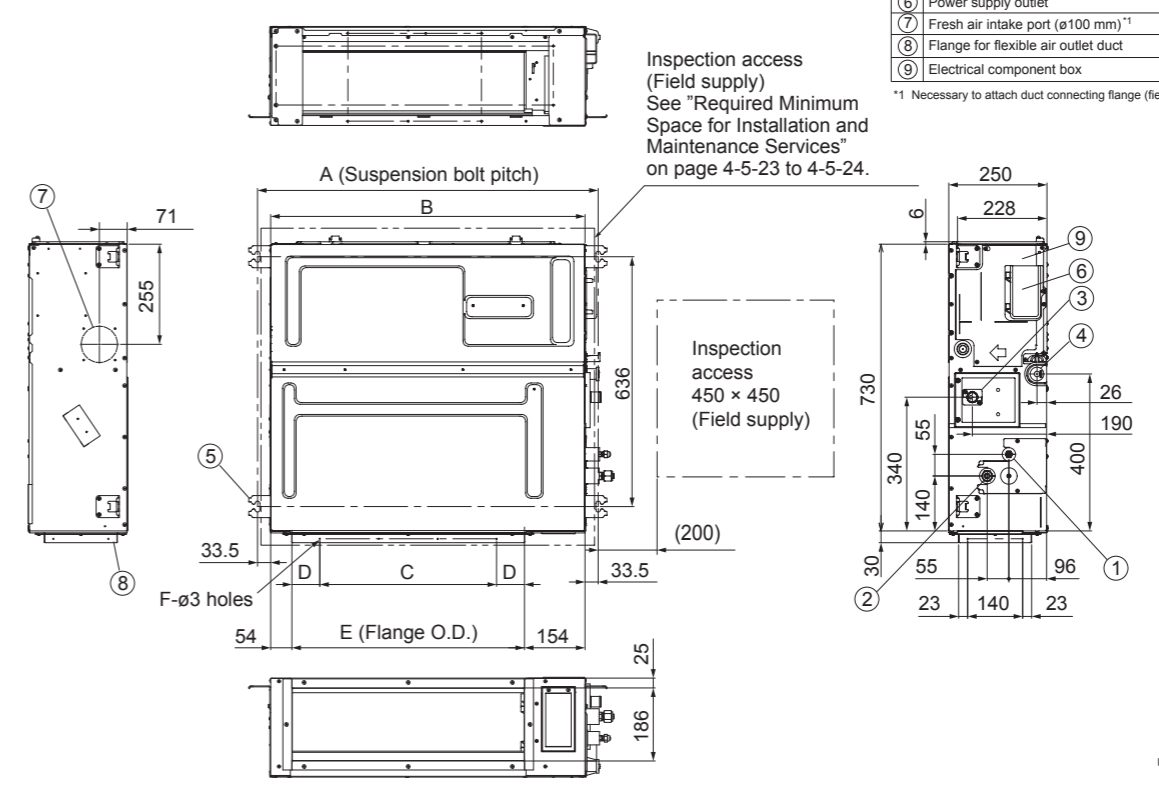

F3 TYPE Mid Static Adaptive Ducted

Control all aspects of your environment with exceptional performance and quiet operation. Vertical installation flexibility offers the perfect solution when ceiling heights are restricted.



S-22MF3E5A / S-28MF3E5A / S-36MF3E5A
S-45MF3E5A / S-56MF3E5A



S-60MF3E5A / S-73MF3E5A / S-90MF3E5A



S-106MF3E5A / S-140MF3E5A / S-160MF3E5A

Optional accessory



CZ-RTC6W
CZ-RTC6WBL
CZ-RTC6WBLW



CZ-RTC6
CZ-RTC6BL
CZ-RTC6BLW



CZ-CENSC1



CZ-RTC5B



CZ-RWS3
Remote controller



CZ-RWRC3
Receiver

Technical focus

- 4 installation possibilities with horizontal and vertical mounting and selectable rear or bottom air inlet
- DC fan motor for variable external static pressure control
- Industry-leading horizontal/vertical design with 250 mm height
- Powerful 150 Pa static pressure in a compact unit.
- Leading-class low sound levels from 20 dB(A)
- Improved drain pan suitable for both horizontal / vertical installation
- nanoe™ X : 20x for CAC (20 times more nanoe™ particle for wide commercial space)
- Possible to control discharge air temperature for accurate room temperature control.

Powerful 150 Pa external static pressure in an industry-leading horizontal/vertical installation design

Delivering static pressure up to 150 Pa external static pressure, the industry-leading horizontal/vertical design offers the power you need in a compact form factor.

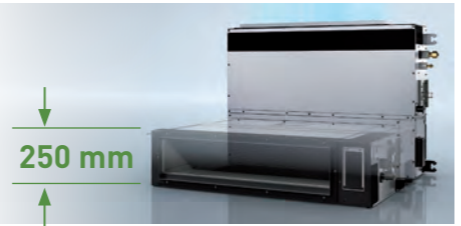

Improved drain pan design

Drain pan is shared in both cases horizontal and vertical installation. No need to alternate anymore.

Shared drain pan

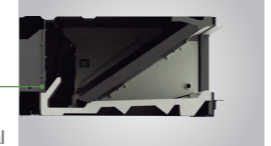

Superior Air Quality

Combined with the strong static pressure this model ensures pristine nanoe™ X air travels unaffected even through multiple duct shapes at lengths of 10 m, as well as making them ideal for use in larger spaces.

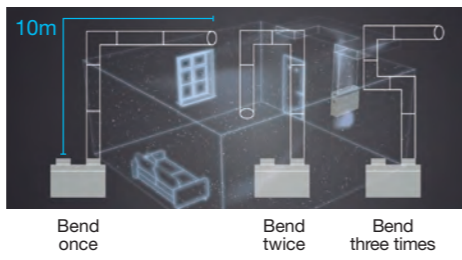

As the experiments demonstrate, even with a total ductwork length of up to 10 m, effectiveness of nanoe™ X is maintained.



Model Name	S-22MF3E5A	S-28MF3E5A	S-36MF3E5A	S-45MF3E5A	S-56MF3E5A		
Power source	220/230/240 V, 1 phase - 50/60 Hz						
Cooling capacity	kW	2.2	2.8	3.6	4.5	5.6	
	BTU/h	7,500	9,600	12,300	15,400	19,100	
Heating capacity	kW	2.5	3.2	4.2	5.0	6.3	
	BTU/h	8,500	10,900	14,300	17,100	21,500	
Power input	Cooling kW	0.06/0.06/0.06	0.06/0.06/0.06	0.06/0.06/0.06	0.06/0.06/0.06	0.089/0.089/0.089	
	Heating kW	0.06/0.06/0.06	0.06/0.06/0.06	0.06/0.06/0.06	0.06/0.06/0.06	0.089/0.089/0.089	
Running amperes	Cooling A	0.46/0.45/0.44	0.46/0.45/0.44	0.46/0.45/0.44	0.46/0.45/0.44	0.65/0.63/0.61	
	Heating A	0.46/0.45/0.44	0.46/0.45/0.44	0.46/0.45/0.44	0.46/0.45/0.44	0.65/0.63/0.61	
Fan motor	Type	Sirocco fan	Sirocco fan	Sirocco fan	Sirocco fan	Sirocco fan	
	Air flow rate (H/M/L)	m³/h	840/720/480	840/720/480	840/720/480	840/720/480	960/840/600
		L/s	233/200/133	233/200/133	233/200/133	233/200/133	267/233/167
	Output	kW	0.107	0.107	0.107	0.107	0.107
External static pressure	Pa	30 (10-150)	30 (10-150)	30 (10-150)	30 (10-150)	30 (10-150)	
Sound power level (H/M/L)	dB	54/51/43	54/51/43	54/51/43	54/51/43	58/55/47	
Sound pressure sound (H/M/L)	dB(A)	31/28/20	31/28/20	31/28/20	31/28/20	35/32/24	
Dimensions	H x W x D	mm	250 x 800 x 730	250 x 800 x 730	250 x 800 x 730	250 x 800 x 730	
		mm (inches)	Ø6.35 (Ø1/4)	Ø6.35 (Ø1/4)	Ø6.35 (Ø1/4)	Ø6.35 (Ø1/4)	Ø6.35 (Ø1/4)
Pipe connections	Gas	mm (inches)	Ø12.7 (Ø1/2)	Ø12.7 (Ø1/2)	Ø12.7 (Ø1/2)	Ø12.7 (Ø1/2)	
	Drain piping		VP-20	VP-20	VP-20	VP-20	
Net weight	kg	26	26	26	26	26	

Built-in Drain pump (DC motor pump)

Space saving height of 250 mm for all models

250 mm standardised height provides easy and uniform installation for models with different capacities, especially when ceiling heights are restricted.

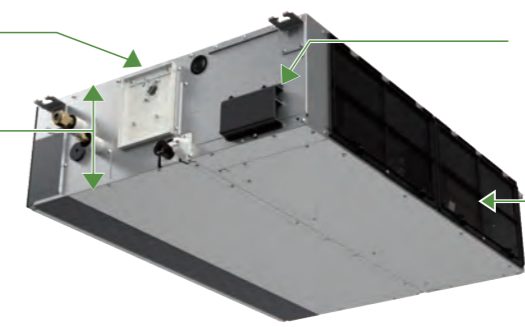

External electrical equipment box makes maintenance easy

Built-in filter

Selectable air inlet position

A removable panel allows air inlet position to be adjusted to enable rear or bottom entry, depending on ductwork installation.

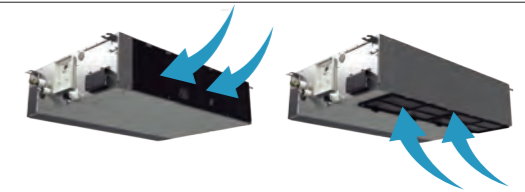

System example

An inspection port (450 mm x 450 mm or larger) is required at the lower side of the indoor unit body.

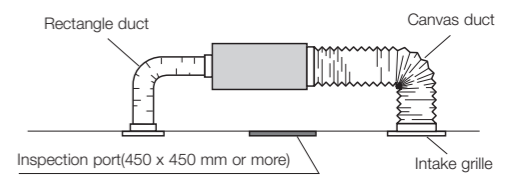

More powerful drain pump

Using a high-lift built-in drain pump, drain piping can be elevated up to 690 mm from the base of the unit.

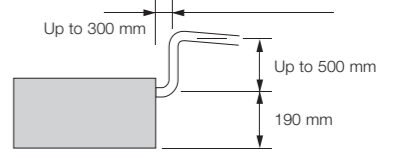

S-60MF3E5A	S-73MF3E5A	S-90MF3E5A	S-106MF3E5A	S-140MF3E5A	S-160MF3E5A
220/230/240 V, 1 phase - 50/60 Hz					
6.0	7.3	9.0	10.6	14.0	16.0
20,500	24,900	30,700	36,200	47,800	54,600
7.1	8.0	10.0	11.4	16.0	18.0
24,200	27,300	34,100	38,900	54,600	61,400
0.079/0.079/0.079	0.079/0.079/0.079	0.136/0.136/0.136	0.146/0.146/0.146	0.265/0.265/0.265	0.330/0.330/0.330
0.079/0.079/0.079	0.079/0.079/0.079	0.136/0.136/0.136	0.146/0.146/0.146	0.265/0.265/0.265	0.330/0.330/0.330
0.53/0.52/0.51	0.53/0.52/0.51	0.92/0.90/0.88	1.03/1.00/0.97	1.80/1.76/1.72	2.22/2.14/2.09
0.53/0.52/0.51	0.53/0.52/0.51	0.92/0.90/0.88	1.03/1.00/0.97	1.80/1.76/1.72	2.22/2.14/2.09
Sirocco fan	Sirocco fan	Sirocco fan	Sirocco fan	Sirocco fan	Sirocco fan
1,260/1,080/900	1,260/1,080/900	1,500/1,380/960	1,920/1,560/1,260	2,220/1,920/1,560	2,400/2,040/1,680
350/300/250	350/300/250	417/383/267	533/433/350	617/533/433	667/567/467
0.165	0.165	0.165	0.259	0.259	0.259
30 (10-150)	30 (10-150)	40 (10-150)	40 (10-150)	50 (10-150)	50 (10-150)
54/51/46	54/51/46	58/56/48	59/55/50	64/59/55	66/60/56
31/28/23	31/28/23	35/33/25	36/32/27	41/36/32	43/37/33
250 x 1,000 x 730	250 x 1,000 x 730	250 x 1,000 x 730	250 x 1,400 x 730	250 x 1,400 x 730	250 x 1,400 x 730
Ø6.35 (Ø1/4)	Ø6.35 (Ø1/4)	Ø6.35 (Ø1/4)	Ø9.52 (Ø3/8)	Ø9.52 (Ø3/8)	Ø9.52 (Ø3/8)
Ø12.7 (Ø1/2)	Ø12.7 (Ø1/2)	Ø12.7 (Ø1/2)	Ø15.88 (Ø5/8)	Ø15.88 (Ø5/8)	Ø15.88 (Ø5/8)
VP-20	VP-20	VP-20	VP-20	VP-20	VP-20
31	31	31	40	40	40

GLOBAL REMARKS

Rated conditions:
Cooling
Indoor air temperature
27°C DB / 19°C WB
Outdoor air temperature
35°C DB / 24°C WB

Rated conditions:
Heating
Indoor air temperature
20°C DB
Outdoor air temperature
7°C DB / 6°C WB

Specifications are subject to change without notice.

F2 TYPE Mid Static Ducted



F2 type is designed specifically for applications requiring fixed square ducting.



S-22MF2E5A8 / S-28MF2E5A8 / S-36MF2E5A8
S-45MF2E5A8 S-56MF2E5A8



S-60MF2E5A8 / S-73MF2E5A8 / S-90MF2E5A8

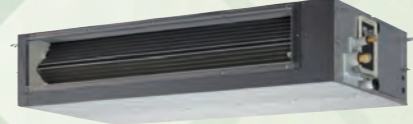

S-106MF2E5A8 / S-140MF2E5A8 / S-160MF2E5A8

Optional accessory



CZ-RTC6W CZ-RTC6WBL



CZ-RTC6 CZ-RTC6BL



CZ-CENSC1



CZ-RTC5B



CZ-RWS3 Remote controller



CZ-RWRC3 Receiver



Self-diagnosing Function



Automatic Fan Operation



Dry mode



Automatic Restart Function



Built-in Drain Pump

Technical focus

- Variable external static pressure control
- Industry-leading low sound levels from 25 dB(A)
- Built-in drain pump provides 702 mm lift
- Easy to install and maintain
- Air off sensor avoids cold air drafts during heating operation
- Configurable air temperature control

Variable external static pressure control

Optimal airflow set-up is possible depending on ducting design and conditions.

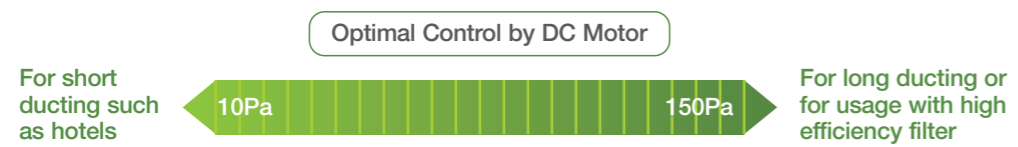

* Please refer to technical databook for detail.

System example

An inspection port (450 mm x 450 mm or larger) is required at the lower side of the indoor unit body.

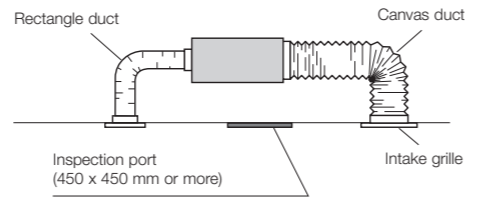

More powerful drain pump

Using a high-lift drain pump, drain piping can be elevated up to 702 mm from the base of the unit.

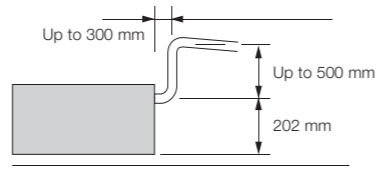

Built-in Drain pump (DC motor pump)

Standardised height of 290 mm for all models

Height standardisation enables easy and uniform installation for models with different capacities.

External electrical equipment box makes maintenance easy

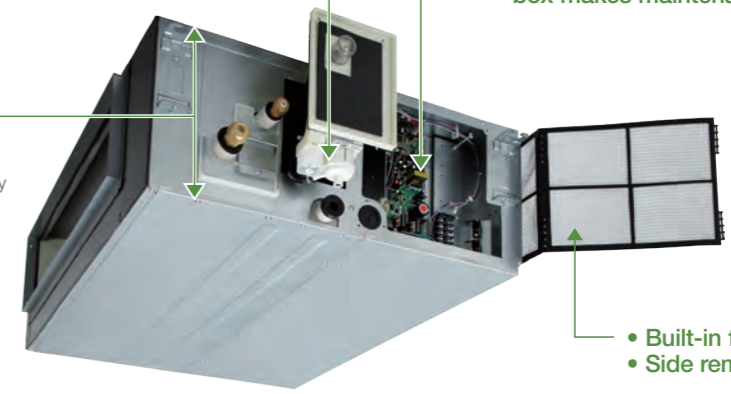

- Built-in filter
- Side removable filter

Discharge air temperature control

- Possible to control discharge air temperature for accurate room temperature control.
 - Possible to reduce cold drafts during heating operation.
- Note: Before spec-in, please consult with an authorised Panasonic dealer.

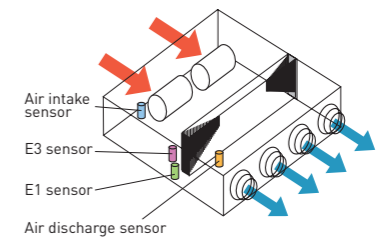

V-shaped heat exchanger

To improve heat exchange efficiency, an original V-shaped heat exchanger was developed incorporating a conventional high-efficiency slit fan and high-efficiency grooved heat transfer tubes. This increases the heat exchange surface area by about 80%.

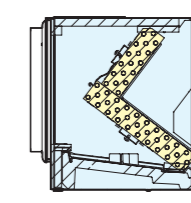

Increases surface area by about 30 to 80%



F2_{TYPE} Mid Static Ducted

Model Name		S-22MF2E5A8	S-28MF2E5A8	S-36MF2E5A8	S-45MF2E5A8	S-56MF2E5A8	
Power source		220/230/240V, 1 phase - 50/60Hz					
Cooling capacity	kW	2.2	2.8	3.6	4.5	5.6	
	BTU/h	7,500	9,600	12,300	15,400	19,100	
Heating capacity	kW	2.5	3.2	4.2	5.0	6.3	
	BTU/h	8,500	10,900	14,300	17,100	21,500	
Power input	Cooling kW	0.070/0.070/0.070	0.070/0.070/0.070	0.070/0.070/0.070	0.070/0.070/0.070	0.100/0.100/0.100	
	Heating kW	0.070/0.070/0.070	0.070/0.070/0.070	0.070/0.070/0.070	0.070/0.070/0.070	0.100/0.100/0.100	
Running amperes	Cooling A	0.60/0.57/0.56	0.60/0.57/0.56	0.60/0.57/0.56	0.60/0.57/0.56	0.77/0.74/0.71	
	Heating A	0.60/0.57/0.56	0.60/0.57/0.56	0.60/0.57/0.56	0.60/0.57/0.56	0.77/0.74/0.71	
Fan motor	Type	Sirocco fan					
	Air flow rate (H/M/L)	m³/h	840/780/540	840/780/540	840/780/540	840/780/600	960/900/720
		L/s	233/217/150	233/217/150	233/217/150	233/217/167	267/250/200
	Output	kW	0.119	0.119	0.119	0.119	0.119
	External static pressure	Pa	70(10-150)				
Sound Power level (H/M/L)	dB	55/51/44	55/51/44	55/51/44	56/54/47	56/54/47	
Sound pressure level (H/M/L)	dB(A)	33/29/22	33/29/22	33/29/22	34/32/25	34/32/25	
Dimensions	H x W x D	mm					
		mm	290x800x700				
Pipe connections	Liquid	mm (inches)	Ø6.35 (Ø1/4)				
	Gas	mm (inches)	Ø12.7 (Ø1/2)				
	Drain piping		VP-25				
Net weight	kg	29	29	29	29	29	

GLOBAL REMARKS	Rated conditions:	Cooling	Heating
	Indoor air temperature	27°C DB / 19°C WB	20°C DB
	Outdoor air temperature	35°C DB / 24°C WB	7°C DB / 6°C WB

Specifications are subject to change without notice.

	S-60MF2E5A8	S-73MF2E5A8	S-90MF2E5A8	S-106MF2E5A8	S-140MF2E5A8	S-160MF2E5A8
Power source	220/230/240V, 1 phase - 50/60Hz					
Cooling capacity	6	7.3	9.0	10.6	14.0	16.0
Heating capacity	7.1	8.0	10.0	11.4	16.0	18.0
Power input	24,200	27,300	34,100	38,900	54,600	61,400
Running amperes	0.120/0.120/0.120	0.120/0.120/0.120	0.135/0.135/0.135	0.195/0.195/0.195	0.215/0.215/0.215	0.225/0.225/0.225
Fan motor	Sirocco fan	Sirocco fan	Sirocco fan	Sirocco fan	Sirocco fan	Sirocco fan
Net weight	46	46	46	46	46	46

F2 TYPE MID STATIC DUCTED Dimensions

SIZE 22-56

- 1 Refrigerant piping joint (liquid tube) Ø6.35 Flare
- 2 Refrigerant piping joint (gas tube) Ø12.7 Flare
- 3 Upper drain port VP25 (O.D. Ø32 mm)
- 4 Bottom drain port VP25 (O.D. Ø32 mm)
- 5 Suspension lug (4-12 x 30 mm)
- 6 Power supply outlet
- 7 Fresh air intake port (Ø150 mm)
- 8 Flange for flexible air outlet duct
- 9 Electrical component box

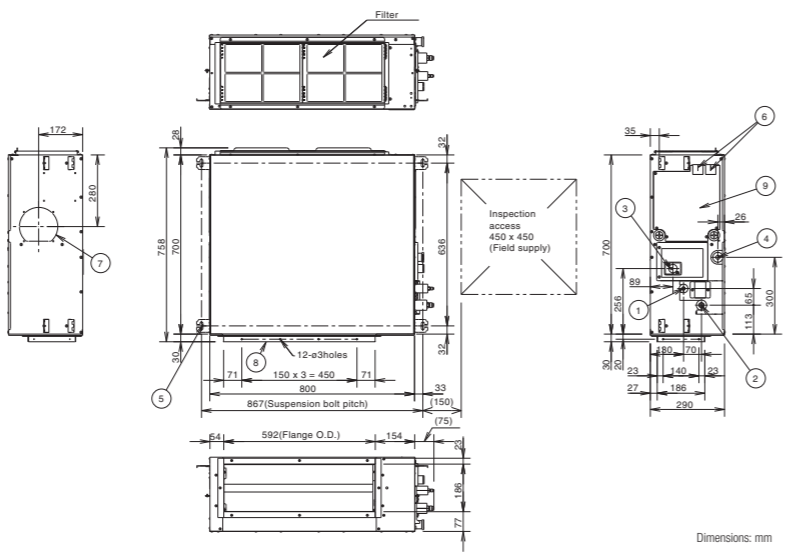

Dimensions: mm

SIZE 60-90

- 1 Refrigerant piping joint (liquid tube) Ø9.52 Flare
- 2 Refrigerant piping joint (gas tube) Ø15.88 Flare
- 3 Upper drain port VP25 (O.D. Ø32 mm)
- 4 Bottom drain port VP25 (O.D. Ø32 mm)
- 5 Suspension lug (4-12 x 30 mm)
- 6 Power supply outlet
- 7 Fresh air intake port (Ø150 mm)
- 8 Flange for flexible air outlet duct
- 9 Electrical component box

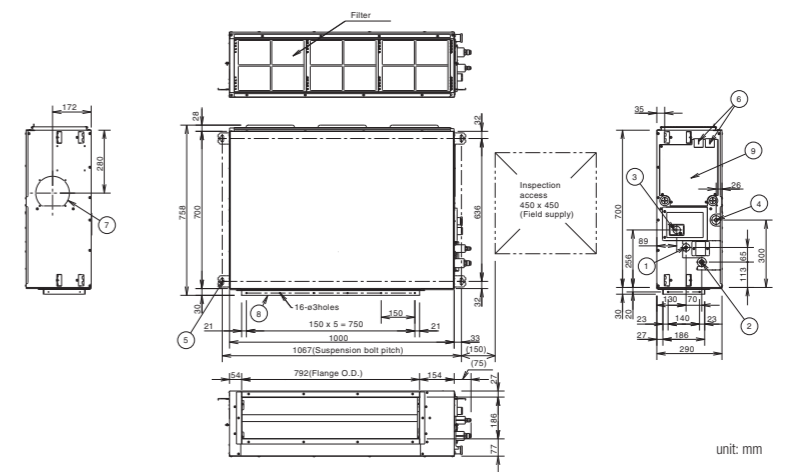

unit: mm

SIZE 106-160

- 1 Refrigerant piping joint (liquid tube) Ø9.52 Flare
- 2 Refrigerant piping joint (gas tube) Ø15.88 Flare
- 3 Upper drain port VP25 (O.D. Ø32 mm)
- 4 Bottom drain port VP25 (O.D. Ø32 mm)
- 5 Suspension lug (4-12 x 30 mm)
- 6 Power supply outlet
- 7 Fresh air intake port (Ø150 mm)
- 8 Flange for flexible air outlet duct
- 9 Electrical component box

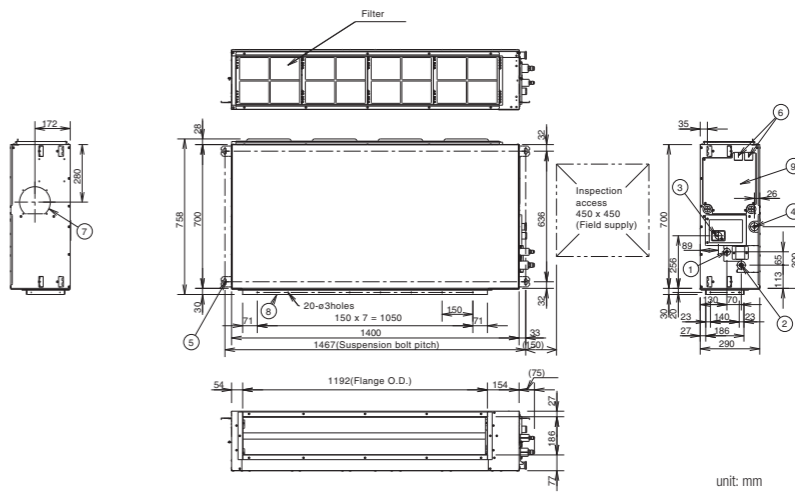

unit: mm

M1_{TYPE} Slim Low Static Ducted Concealed duct



The ultra slim M1 type is one of the leading products of its type in the industry. With a height of only 200 mm, it provides greater flexibility and adaptability for various applications. In addition, high efficiency and extreme low noise level make it highly suitable for hotels and small offices.



S-22MM1E5A / S-28MM1E5A / S-36MM1E5A
S-45MM1E5A / S-56MM1E5A

Optional accessory



Technical focus

- Ultra-slim profile: 200 mm for all models
- DC fan motor greatly reduces power consumption
- Ideal for hotel application with very narrow false ceilings
- Easy maintenance and service by external electrical box
- 40 Pa static pressure enables ductwork to be fitted.
- Includes drain pump
- Includes built in filter

Ultra-slim profile for all models

200mm height for all models allows installation in very narrow ceilings.



Drain pump with increased power!

Using the built-in high-lift drain pump, the drain piping rise height can be increased to 653 mm from the lower surface of the body.

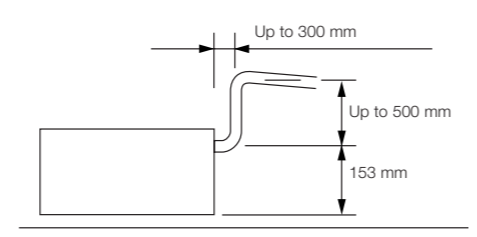

Model Name		S-22MM1E5A	S-28MM1E5A	S-36MM1E5A	S-45MM1E5A	S-56MM1E5A	
Power source		220/230/240 V, 1 phase - 50/60 Hz					
Cooling capacity	kW	2.2	2.8	3.6	4.5	5.6	
	BTU/h	7,500	9,600	12,300	15,400	19,100	
Heating capacity	kW	2.5	3.2	4.2	5.0	6.3	
	BTU/h	8,500	10,900	14,300	17,100	21,500	
Power input	Cooling kW	0.036/0.036/0.036	0.040/0.040/0.040	0.042/0.042/0.042	0.049/0.049/0.049	0.064/0.064/0.064	
	Heating kW	0.026/0.026/0.026	0.030/0.030/0.030	0.032/0.032/0.032	0.039/0.039/0.039	0.054/0.054/0.054	
Running current	Cooling A	0.26/0.26/0.26	0.30/0.30/0.30	0.31/0.31/0.31	0.37/0.37/0.37	0.48/0.48/0.48	
	Heating A	0.23/0.23/0.23	0.27/0.27/0.27	0.28/0.28/0.28	0.34/0.34/0.34	0.45/0.45/0.45	
Fan	Type	Sirocco fan					
	Air flow rate (H/M/L)	m ³ /h	480/420/360	510/450/390	540/480/420	630/570/480	750/690/600
		L/s	133/117/100	142/125/108	150/133/117	175/158/133	208/192/167
	Motor output	kW	0.06	0.06	0.06	0.06	0.06
	External static pressure	Pa	10 (30)	15 (30)	15 (40)	15 (40)	15 (40)
Sound power level (H/M/L)	dB	43/42/40	45/44/42	47/45/43	49/47/45	50/48/46	
Sound pressure level (H/M/L)	dB(A)	28/27/25 (30/29/27)*	30/29/27 (32/31/29)*	32/30/28 (34/32/30)*	34/32/30 (36/34/32)*	35/33/31 (37/35/32)*	
Dimensions	H x W x D	mm 200 x 750 x 640					
	Liquid	mm (inches)	Ø6.35 (Ø1/4)	Ø6.35 (Ø1/4)	Ø6.35 (Ø1/4)	Ø6.35 (Ø1/4)	Ø6.35 (Ø1/4)
Pipe connections	Gas	mm (inches)	Ø12.7 (Ø1/2)	Ø12.7 (Ø1/2)	Ø12.7 (Ø1/2)	Ø12.7 (Ø1/2)	Ø12.7 (Ø1/2)
	Drain piping		VP-20	VP-20	VP-20	VP-20	VP-20
Net weight	kg	19	19	19	19	19	

GLOBAL REMARKS: Rated conditions: Cooling 27°C DB / 19°C WB, Heating 20°C DB. Outdoor air temperature 35°C DB / 24°C WB, 7°C DB / 6°C WB. Specifications are subject to change without notice. * With booster cable.

M1 TYPE SLIM LOW STATIC DUCTED Dimensions

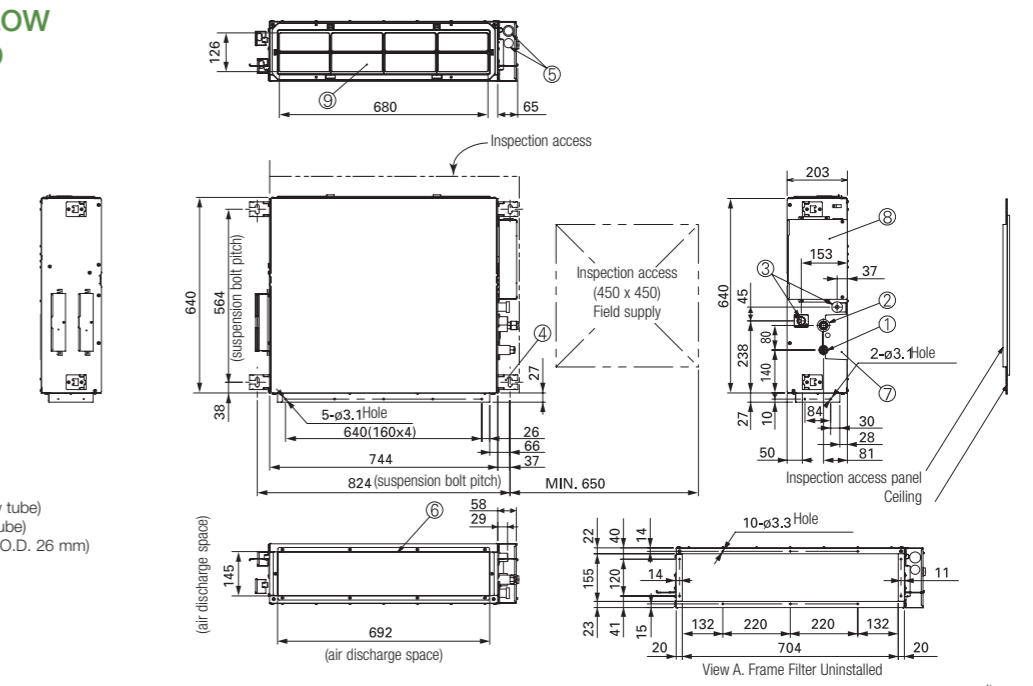

- 1 Refrigerant piping joint (narrow tube)
- 2 Refrigerant piping joint (wide tube)
- 3 Upper and bottom drain port (O.D. 26 mm)
- 4 Suspension lug
- 5 Power supply outlet (2- Ø30)
- 6 Flange for air intake duct
- 7 PI cover
- 8 Electrical component box
- 9 Frame filter

unit: mm

Z1 TYPE Slim Low Static Ducted Twenty Series Concealed duct

The ultra slim Z1 type is one of the leading products of its type in the industry. With a height of only 200 mm, it provides greater flexibility and adaptability for various applications. In addition, high efficiency and extreme low noise level make it highly suitable for hotels and small offices.



Optional accessory

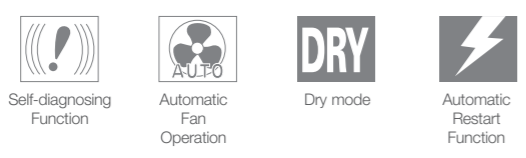

Technical focus

- Ultra-slim profile: 200 mm for all models
- DC fan motor greatly reduces power consumption
- Ideal for hotel application with very narrow false ceilings
- Easy maintenance and service by external electrical box
- 29 Pa static pressure enables ductwork to be fitted.
- Drain pump (optional)

Ultra-slim profile for all models

200mm height for all models allows installation in very narrow ceilings.

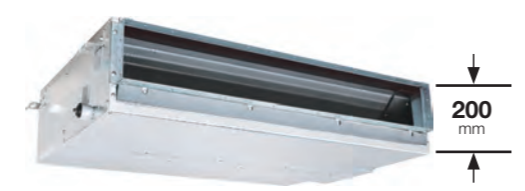

Drain pump with increased power! (optional)

Using the optional high-lift drainage pump, the drain piping rise height can be increased up to 1,000 mm from the drain pipe port.

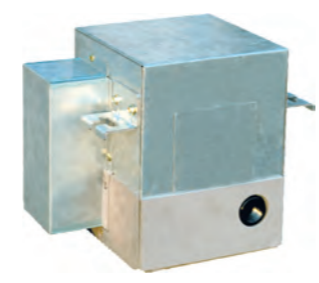

CZ-73DMZ1

Model Name		S-22MZ1H4A	S-28MZ1H4A	S-36MZ1H4A	S-45MZ1H4A	S-56MZ1H4A	S-60MZ1H4A	S-73MZ1H4A	
Power source		220/230/240 V, 1 phase - 50/60 Hz							
Cooling capacity	kW	2.2	2.8	3.6	4.5	5.6	6.0	7.3	
	BTU/h	7,500	9,500	12,200	15,300	19,100	20,500	24,900	
Heating capacity	kW	2.5	3.2	4.2	5.1	6.4	7.1	8.0	
	BTU/h	8,500	10,900	14,300	17,400	21,800	24,200	27,300	
Power input	Cooling kW	0.075/0.075/0.075	0.080/0.080/0.080	0.085/0.085/0.085	0.095/0.095/0.095	0.100/0.100/0.100	0.100/0.100/0.100	0.125/0.125/0.125	
	Heating kW	0.075/0.075/0.075	0.080/0.080/0.080	0.085/0.085/0.085	0.095/0.095/0.095	0.100/0.100/0.100	0.100/0.100/0.100	0.125/0.125/0.125	
Running current	Cooling A	0.50/0.47/0.45	0.55/0.52/0.50	0.60/0.57/0.55	0.70/0.68/0.65	0.75/0.72/0.70	0.75/0.72/0.70	0.80/0.78/0.75	
	Heating A	0.50/0.47/0.45	0.55/0.52/0.50	0.60/0.57/0.55	0.70/0.68/0.65	0.75/0.72/0.70	0.75/0.72/0.70	0.80/0.78/0.75	
Fan	Type	Sirocco fan	Sirocco fan	Sirocco fan	Sirocco fan	Sirocco fan	Sirocco fan	Sirocco fan	
	Air flow rate (H/M/L)	m ³ /h	480/420/360	600/540/420	600/540/420	690/630/510	720/660/540	870/750/630	1,080/840/660
		L/s	133/117/100	167/150/117	167/150/117	192/175/142	200/183/150	242/208/175	300/233/183
	Motor output	kW	0.06	0.06	0.06	0.06	0.06	0.06	0.06
External static pressure	Pa	10-30	10-30	10-30	10-30	10-30	10-30	10-30	
Sound power level (H/M/L)	dB	50/49/47	52/51/49	54/52/50	56/54/52	57/55/53	60/57/55	62/60/58	
Sound pressure level (H/M/L)	dB(A)	28/27/25	30/29/27	32/30/28	34/32/30	35/33/31	38/35/33	40/38/36	
Dimensions	H x W x D	mm	200x830x500	200x830x500	200x830x500	200x830x500	200x830x500	200x1,050x550	
	Liquid	mm (inches)	Ø6.35 (Ø1/4)	Ø6.35 (Ø1/4)	Ø6.35 (Ø1/4)	Ø6.35 (Ø1/4)	Ø6.35 (Ø1/4)	Ø9.52 (Ø3/8)	Ø9.52 (Ø3/8)
Pipe connections	Gas	mm (inches)	Ø12.7 (Ø1/2)	Ø12.7 (Ø1/2)	Ø12.7 (Ø1/2)	Ø12.7 (Ø1/2)	Ø15.88 (Ø5/8)	Ø15.88 (Ø5/8)	
	Drain piping		VP-25	VP-25	VP-25	VP-25	VP-25	VP-25	
Net weight	kg	17	17	18	18	18	18	24	
GLOBAL REMARKS	Rated conditions:	Cooling	Heating						
	Indoor air temperature	27°C DB / 19°C WB	20°C DB						
	Outdoor air temperature	35°C DB / 24°C WB	7°C DB / 6°C WB						

Specifications are subject to change without notice.

Z1 TYPE SLIM LOW STATIC DUCTED TWENTY SERIES Dimensions

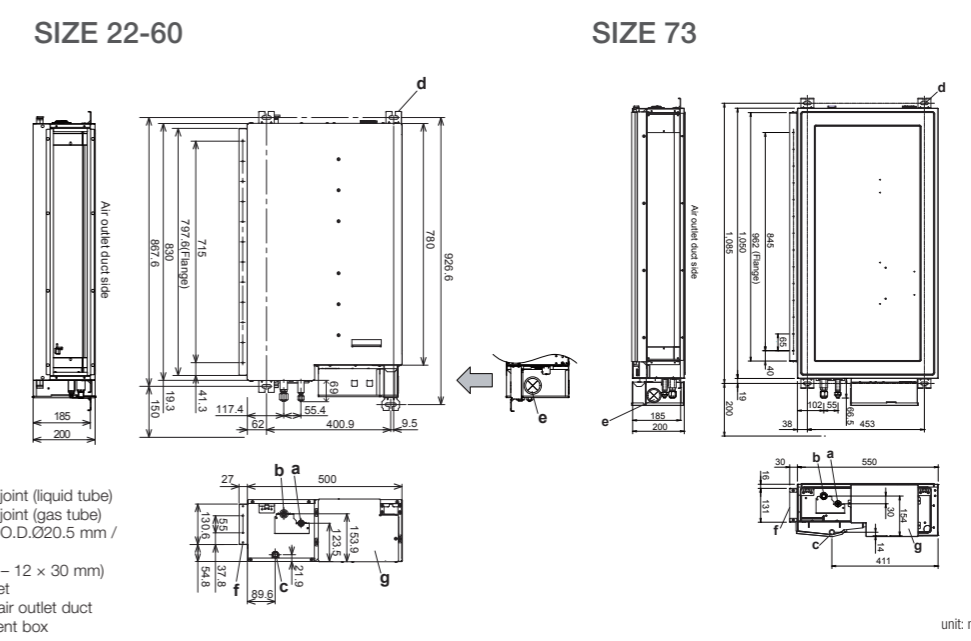

- a) Refrigerant tubing joint (liquid tube)
- b) Refrigerant tubing joint (gas tube)
- c) Bottom drain port O.D.Ø20.5 mm / I.D. Ø15.5mm
- d) Suspension lug (4 – 12 x 30 mm)
- e) Power supply outlet
- f) Flange for flexible air outlet duct
- g) Electrical component box

unit: mm

E2 TYPE High Static Ducted



Concealed duct / Air conditioning mode Optional accessory



S-180ME2E5
S-224ME2E5
S-280ME2E5



CZ-RTC6W
CZ-RTC6WBL

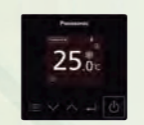

CZ-RTC6
CZ-RTC6BL



CZ-RTC5B



CZ-RWS3
Remote controller



CZ-RWRC3
Receiver

E2 TYPE Energy Saving High Fresh Air Ducted



Concealed duct high-static pressure Optional accessory



S-224ME2E5
S-280ME2E5



CZ-RTC6W
CZ-RTC6WBL



CZ-RTC6
CZ-RTC6BL



CZ-RTC5B



CZ-RWS3
Remote controller



CZ-RWRC3
Receiver

Technical focus

- Design flexibility thanks to high static pressure and large air volume
- DC motor equipped
- Power input 45% less (compared to E1 type)
- Discharge air temperature control to reduce cold drafts during heating operation
- Configurable air temperature control
- Available Fresh Air Intake mode (See page 29)

3-step static pressure set up

You can select between the three Static Pressure modes of 270 Pa/140 Pa/60(72*) Pa for extra installation flexibility.

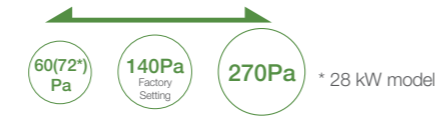

Max. 270Pa static pressure setting

A maximum static pressure setting of a high 270Pa enables the use of long ducts for installation in a wide range of spaces. Ideal for large-scale offices, restaurants and other facilities.

Sensible cooling 5-10% improved

New heat exchanger with ϕ 7mm pipe that increases the heat transfer surface to improve sensible cooling (5-10% improvement)

Discharge air temperature control

- Equipped with 4 sensors (Intake/ Discharge)
- Able to control discharge air temperature for accurate room temperature control.
- Possible to reduce cold drafts during heating operation.

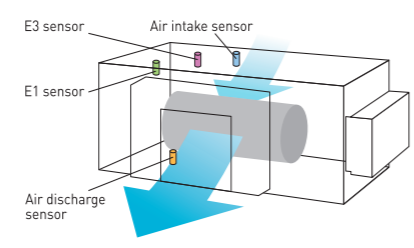

Model Name		S-180ME2E5	S-224ME2E5	S-280ME2E5
Power source		220/230/240V, 1 Phase-50 Hz, 220/230V, 1 Phase-60Hz		
Cooling capacity	kW	18.0	22.4	28.0
	BTU/h	61,400	76,400	95,500
Heating capacity	kW	20.0	25.0	31.5
	BTU/h	68,200	85,300	107,500
Power input	Cooling kW	0.400	0.440	0.715
	Heating kW	0.400	0.440	0.715
Running current	Cooling A	2.40 / 2.30 / 2.20	2.55 / 2.45 / 2.35	3.95 / 3.85 / 3.70
	Heating A	2.40 / 2.30 / 2.20	2.55 / 2.45 / 2.35	3.95 / 3.85 / 3.70
Fan	Type	Sirocco fan		
	Air flow rate (H/M/L)	m ³ /h 2,940 / 2,640 / 2,340	m ³ /h 3,360 / 3,060 / 2,640	m ³ /h 4,320 / 3,780 / 3,180
		L/s 817 / 733 / 650	L/s 933 / 850 / 733	L/s 1,200 / 1,050 / 883
	Motor output	kW 0.560 x 2		
	External static pressure	Pa 140 (60/270)	Pa 140 (60/270)	Pa 140 (72/270)
Sound power level (H/M/L)	dB	76 / 74 / 72	77 / 75 / 73	81 / 79 / 75
Sound pressure level (H/M/L)	dB(A)	44 / 42 / 40	45 / 43 / 41	49 / 47 / 43
Dimensions	H x W x D	mm 479 x 1,453 x 1,205		
	Pipe connections	Liquid mm (inches) Gas mm (inches)	mm (inches) 09.52 (3/8) 09.52 (3/8) 09.52 (3/8)	
Drain piping	VP-25	VP-25		
	Net weight	kg 102	kg 102	kg 106

Global remarks	Rated conditions:	
	Cooling	Heating
	Indoor air temperature	27°C DB / 19°C WB
Outdoor air temperature	35°C DB / 24°C WB	7°C DB / 6°C WB

Technical focus

- 100% fresh air intake for ventilation purpose
- Design flexibility with high static pressure and large air volume
- DC motor equipped
- Power input 45% less (compared to H1 type)
- Discharge air temperature control to reduce cold drafts during heating operation
- Configurable air temperature control

High fresh system

High Fresh System enables delivery of fresh outside air at almost the same temperature and humidity as indoor air without putting a burden on air conditioning.

* Capable of treating outdoor air only. Indoor air conditioner units are required to adjust indoor air temperature.

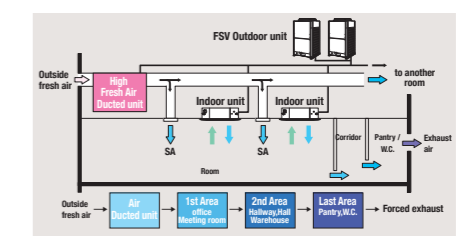

Mix operation unit with standard indoor units

Possible to combine High Fresh Air ducted indoor unit and standard air ducted indoor units.

When other indoor units are connected in same circuit, keep following capacity ratio.

E2 type/Outdoor unit < 30%, and Total of indoors(incl. E2)/outdoor < 100%

Remark For High Static Ducted Series

Model	Type of Outdoor unit	Rap valve kit CZ-P160RVK2	3way control PCB CZ-CAPE2	3way valve kit CZ-P160HR3	Distribution Joint kit <2pipes> CZ-P160BK2 for 22.4kW unit or less CZ-P680BK2 for more than 22.4kW	Distribution Joint kit <3pipes> CZ-P224BH2 for 22.4kW unit CZ-P680BH2 for 28.0kW unit
E2 Type High Static Ducted (Only for S-224,S-280)	Cooling Only	-	-	-	-	-
	Cooling or Heating (2-WAY system)	2pcs	2pcs	-	2pcs	-
	Heat Recovery	-	-	2pcs	-	2pcs

Model Name		S-224ME2E5	S-280ME2E5
Power source		220/230/240V, 1 Phase-50 Hz, 220/230V, 1 Phase-60Hz	
Cooling capacity	kW	22.4	28.0
	BTU/h	76,400	95,500
Heating capacity	kW	21.2	26.5
	BTU/h	72,300	90,400
Power input	Cooling kW	0.290	0.350
	Heating kW	0.290	0.350
Running current	Cooling A	1.90/1.85/1.80	2.30/2.20/2.10
	Heating A	1.90/1.85/1.80	2.30/2.20/2.10
Fan	Type	Sirocco fan	
	Air flow rate	m ³ /h 1,700	m ³ /h 2,100
		L/s 472	L/s 583
	Motor output	kW 0.560 x 2	
	External static pressure	Pa 200	Pa 200
Sound power level	dB	75	76
Sound pressure level	dB(A)	43	44
Dimensions	H x W x D	mm 479 x 1,453 x 1,205	
	Pipe connections	Liquid mm (inches) Gas mm (inches)	mm (inches) 09.52 (3/8) 09.52 (3/8) 09.52 (3/8)
Drain piping	VP-25	VP-25	
	Net weight	kg 102	kg 106

Global remarks	Rated conditions:	
	Cooling	Heating
	Outdoor air temperature	33°C DB / 28°C WB

E1 TYPE High Static Ducted

Concealed duct high-static pressure



S-73ME1E5 / S-106ME1E5 / S-140ME1E5



S-224ME1E5 / S-280ME1E5

Optional accessory



CZ-RTC6W
CZ-RTC6WBL



CZ-RTC6
CZ-RTC6BL



CZ-RTC5B



Optional Controller
Wireless remote controller
CZ-RWS3 + CZ-RWRC3

Technical focus

- Complete flexibility for ductwork design
- Can be located into a weatherproof housing for external installation
- Discharge air temperature control to reduce cold drafts during heating operation
- Configurable air temperature control

System example

An inspection port (450 x 450 mm or more) is required at the lower side of the indoor unit body (field supply).

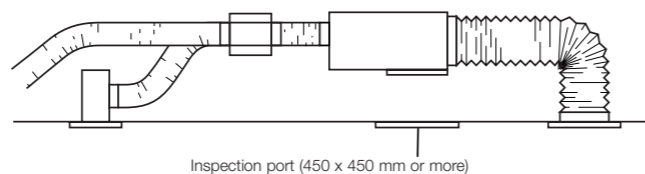

Discharge air temperature control

- Equipped with 4 sensors (Intake/ Discharge)
- Able to control discharge air temperature for accurate room temperature control.
- Possible to reduce cold drafts during heating operation.

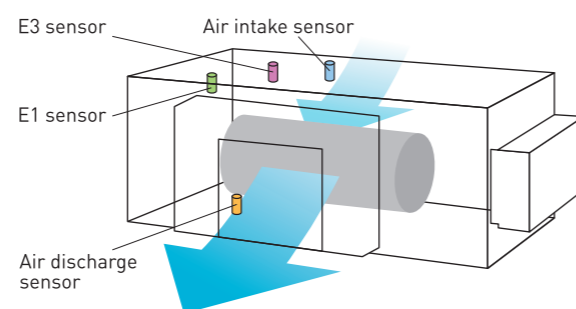

Remark For High Static Ducted Series

Model Indoor Unit	Operation	Rap valve kit CZ-P160RVK2	3way control PCB CZ-CAPE2	3WAY Valve Kit (Single SVK) CZ-P160HR3	3WAY Valve Kit multiple connection port type 4ports (Multiple SVK) CZ-P4160HR3 (160 type x 4)	Solenoid Valve Relay Kit (Bundled in CZ-P4160HR3)	Distribution Joint kit <2pipes> CZ-P160BK2 for 22.4kW or less CZ-P680BK2 for more than 22.4kW	Distribution Joint kit <3pipes> CZ-P224BH2 for 22.4kW or less CZ-P680BH2 for 28.0kW unit
E1 Type High Static Ducted (Only for S-224,S-280)	Cooling Only	-	-	-	-	-	-	-
	Cool or Heat	2pcs	-	-	-	-	2pcs	-
	Heat Recovery	-	-	2pcs	-	-	1pcs	1pcs
		-	-	-	use 2ports (160 x 2)	use 1pcs	1pcs	-

*Please consult with Panasonic sales engineers for further information.

Model Name		S-73ME1E5	S-106ME1E5	S-140ME1E5	S-224ME1E5	S-280ME1E5	
Power source		220/230/240 V, 1 phase - 50 / 60 Hz				220/230/240 V, 1 phase - 50 Hz	
Cooling capacity	kW	7.3	10.6	14.0	22.4	28.0	
	BTU/h	25,000	36,000	47,800	76,400	95,500	
Heating capacity	kW	8.0	11.4	16.0	25.0	31.5	
	BTU/h	27,000	39,000	54,600	85,300	107,500	
Power input	Cooling kW	0.480/0.505/0.530	0.520/0.545/0.570	0.600/0.660/0.710	0.870/0.900/0.930	1.270/1.330/1.390	
	Heating kW	0.480/0.505/0.530	0.520/0.545/0.570	0.600/0.660/0.710	0.870/0.900/0.930	1.270/1.330/1.390	
Running current	Cooling A	2.29/2.30/2.31	2.46/2.46/2.47	2.80/2.90/3.00	4.05/4.06/4.07	6.04/6.06/6.07	
	Heating A	2.29/2.30/2.31	2.46/2.46/2.47	2.80/2.90/3.00	4.05/4.06/4.07	6.04/6.06/6.07	
Fan	Type	Sirocco fan	Sirocco fan	Sirocco fan	Sirocco fan	Sirocco fan	
	Air flow rate (H/M/L)	m³/h	1,380/1,320/1,260	1,800/1,680/1,500	2,160/2,100/1,980	3,360/3,190/2,980	4,320/4,200/3,960
		L/s	383/367/350	500/467/417	600/583/550	933/886/828	1,200/1,167/1,100
	Motor output	kW	0.2	0.2	0.35	0.2	0.4
	External static pressure	Pa	186	176	167	176	216 (235)*
Sound power level (H/M/L)	dB	55/54/53	56/55/53	58/57/55	59/58/57	62/61/60	
Sound pressure level (H/M/L)	dB(A)	44/43/42	45/44/42	47/46/44	48/47/46	51/50/49 (52/51/50)*	
Dimensions	H x W x D	mm	420 x 1,065 x 620	420 x 1,065 x 620	450 x 1,065 x 620	479 x 1,428 x 1,230	479 x 1,428 x 1,230
	Liquid	mm (inches)	Ø9.52 (Ø3/8)	Ø9.52 (Ø3/8)	Ø9.52 (Ø3/8)	Ø9.52 (Ø3/8)	Ø9.52 (Ø3/8)
Pipe connections	Gas	mm (inches)	Ø15.88 (Ø5/8)	Ø15.88 (Ø5/8)	Ø15.88 (Ø5/8)	Ø19.05 (Ø3/4)	Ø22.22 (Ø7/8)
	Drain piping		VP-25	VP-25	VP-25	VP-25	VP-25
Net weight	kg	47	50	54	110	120	

Global remarks	Rated conditions:	
	Cooling	Heating
	Indoor air temperature	27°C DB / 19°C WB
Outdoor air temperature	35°C DB / 24°C WB	7°C DB / 6°C WB

Specifications are subject to be changed without notice.
* Via booster cable.



K2 TYPE Wall Mounted



Optional accessory



*Receiver is included in the wall mounted indoor unit.

Technical focus

- Closed discharge port when not in use
- Lighter and smaller units make installation easy
- Quiet operation
- Smooth and durable design
- Piping outlet in six directions
- Washable front panel
- Air distribution is automatically altered depending on the operational mode of the unit

Noise reducing external valve kit

To reduce noise level of expansion valve.
(Optional accessory)



CZ-P56SVK2 (for 22 - 56 type)
CZ-P160SVK2 (for 73* - 106 type)
*When the pipe diameter is (Liquid) Ø6.35- (Gas) Ø12.7, please use CZ-P56SVK2.

Closed discharge port

When the unit is turned off, the flap closes completely to prevent entry of dust into the unit and to keep the equipment clean.

Model Name	S-22MK2E5A	S-28MK2E5A	S-36MK2E5A	S-45MK2E5A		
Power source	220/230/240 V, 1 phase - 50 / 60 Hz					
Cooling capacity	kW	2.2	2.8	3.6	4.5	
	BTU/h	7,500	9,600	12,300	15,400	
Heating capacity	kW	2.50	3.20	4.20	5.0	
	BTU/h	8,500	10,900	14,300	17,100	
Power input	Cooling kW	0.025/0.025/0.025	0.025/0.025/0.025	0.030/0.030/0.030	0.030/0.030/0.030	
	Heating kW	0.025/0.025/0.025	0.025/0.025/0.025	0.030/0.030/0.030	0.030/0.030/0.030	
Running current	Cooling A	0.21	0.23	0.25	0.33/0.32/0.31	
	Heating A	0.21	0.23	0.25	0.33/0.32/0.31	
Fan	Type	Cross-flow fan				
	Air flow rate (H/M/L)	m³/h	540/450/390	570/498/390	654/540/390	870/750/600
		L/s	150/125/108	158/138/108	182/150/108	242/208/167
	Motor output kW	0.03	0.03	0.03	0.054	
Sound power level (H/M/L)	dB	51/48/44	52/49/44	55/51/44	53/50/48	
Sound pressure level (H/M/L)	dB(A)	36/33/29	37/34/29	40/36/29	38/35/33	
Dimensions	H x W x D	mm 290 x 870 x 214				
	Liquid	mm (inches) Ø6.35 (Ø1/4)				
	Gas	mm (inches) Ø12.7 (Ø1/2)				
Pipe connections	Gas	mm (inches) Ø12.7 (Ø1/2)				
	Drain piping	mm Ø18				
Net weight	kg	9	9	9	13	

Global remarkszz	Rated conditions:	
	Cooling	Heating
	Indoor air temperature	27°C DB / 19°C WB
Outdoor air temperature	35°C DB / 24°C WB	7°C DB / 6°C WB

Specifications are subject to change without notice.

Compact indoor units make the installation easy

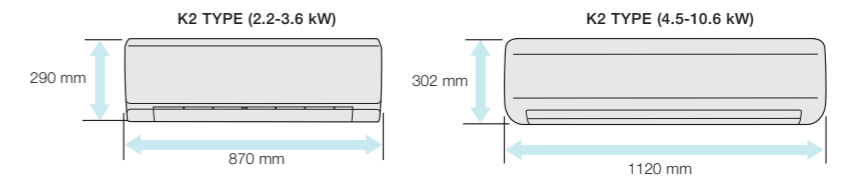

Quiet operation

Low operating noise level makes these units ideal for hotels and hospital applications.

Smooth and durable design

The smooth cover means these units match most modern interiors. Their compact size enables them to blend in, even in small spaces.

Piping outlet in six directions

Piping outlet is possible in the six directions of right, right rear, right bottom, left, left rear, left bottom, making installation easier.

Washable front panel

The indoor unit's front panel can be easily removed and washed for trouble-free maintenance.



Air distribution is automatically adjusted depending on the operational mode of the unit

Air outlet angle is automatically adjusted for cooling and heating operation.

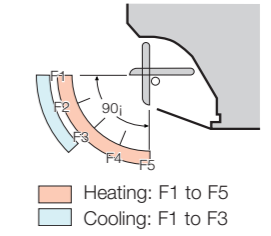

S-56MK2E5A	S-73MK2E5A	S-106MK2E5A
220/230/240 V, 1 phase - 50 / 60 Hz		
5.6	7.3	10.6
19,100	24,900	36,200
6.3	8.0	11.4
21,500	27,300	38,900
0.035/0.035/0.035	0.055/0.055/0.055	0.080/0.080/0.080
0.035/0.035/0.035	0.055/0.055/0.055	0.080/0.080/0.080
0.36/0.35/0.34	0.52/0.51/0.50	0.72/0.70/0.68
0.36/0.35/0.34	0.52/0.51/0.50	0.72/0.70/0.68
Cross-flow fan	Cross-flow fan	Cross-flow fan
960/840/720	1,170/1,020/840	1,290/1,110/900
267/233/200	325/283/233	358/308/250
0.054	0.054	0.054
55/52/50	62/59/55	64/61/57
40/37/35	47/44/40	49/46/42
302 x 1,120 x 236	302 x 1,120 x 236	302 x 1,120 x 236
Ø6.35 (Ø1/4)	Ø9.52 (Ø3/8)	Ø9.52 (Ø3/8)
Ø12.7 (Ø1/2)	Ø15.88 (Ø5/8)	Ø15.88 (Ø5/8)
Ø18	Ø18	Ø18
13	14	14

NEW
U2TYPE 4-Way Cassette
 Semi concealed cassette



Please refer to the nanoe™ X website for the Mark 3 information.

Provides a neat fit in the ceiling to match modern décor, and uniform cooling throughout the room, and easy installation.



- AIR INTAKE CHAMBER**
- 1 Air intake flange (ø100) (field supply)
 - 2 Air intake box CZ-ATU2*(ø100)
 - 3 Air intake plenum CZ-FDU3
- * When using Air intake box (CZ-ATU2), Air intake plenum (CZ-FDU3) is required.

NEW PANEL DESIGN
 Flat design, well-matched with interior, building.



Normal Panel : CZ-KPU3H
 ECONAVI Panel : CZ-KPU3A



Optional accessory

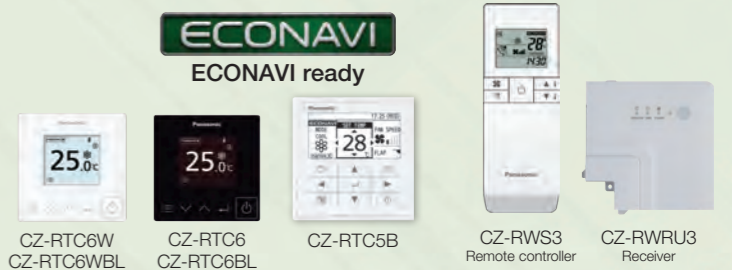

Technical focus

- New high performance turbo fan, new path system for heat exchanger
- Lower noise in slow fan operation
- Industry top light weight, easy piping
- Easy installation structure of the panel
- Econavi : Floor temperature and human sensor added. Activity amount detection and new circulator
- nanoe™ X : 100x for CAC (100 times more nanoe™ particle for wide commercial space). Inside cleaning by 100x nanoe™ + dry control

Flat Horizontal Design

The horizontal design of 4-way cassette achieves an elegant designed panel. Its slim design allow to protrude 33.5mm from the ceiling.

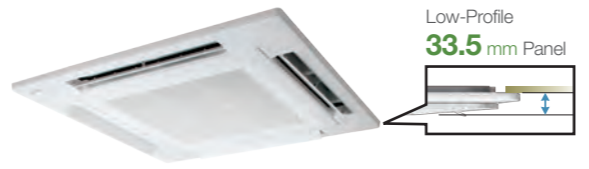

Drain pump of up to 850 mm from the ceiling surface

Built in drain pump allows flexible install and design options with up to 850mm lift. Long horizontal piping is also possible.

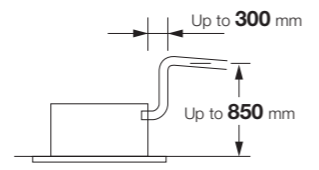

Easy to clean suction grille

Suction grille is able to make 90-degree turns.

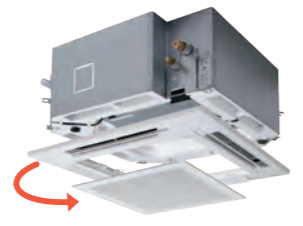

360° Wide & Comfortable Airflow

Comfort air flow control and proper energy use. Flexible Air Flow direction control by individual flap control:
 -4 Flaps can be controlled individually (by standard wired remote controller*)
 -Versatile air flow control to cover a wide variety of demands.

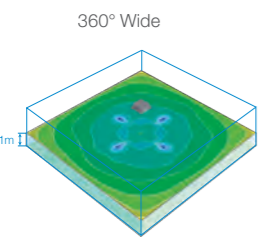

Temperature distribution by thermograph (cooling operation)

Simulation conditions:
 140M 4-way ceiling-mounted cassette type in cooling mode
 / Floor area of 225 m²
 / Ceiling height of 3 m

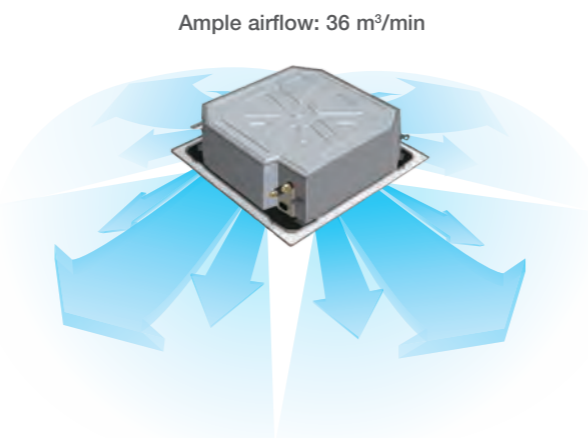

*Pre-setting is required for this function at System Test-run procedure

High-ceiling installation (Up to 5 m for 10.6 kW and higher capacity models)

The units can be installed in rooms with high ceilings, where they provide ample floor-level heating in the winter. (See ceiling height guidelines below.)

High Ceiling (Factory settings)

New model	2.7m	3.0m	3.6m
Capacity	2.2-5.6kW	6.0-9.0kW	11.2-16.0kW

11.2-16.0kW	4.5m	4.7m	5m
Capacity	4-way discharge high ceiling setting 2	3-way discharge with the optional air-blocking materials	2-way discharge with the optional air-blocking materials

Ceiling height guidelines

Indoor unit	*1 settings 4-way discharge			3-way discharge (optional air-blocking materials)	2-way discharge (optional air-blocking materials) *2
	Factory setting 1	High ceiling setting 1	High ceiling setting 2		
2.2-5.6kW	2.7	3.2	3.5	3.8	4.2
6.0-9.0kW	3.0	3.3	3.6	3.8	4.2
11.2-16.0kW	3.6	4.3	5.0	4.7	5.0

*1 When using the unit in a configuration other than the factory settings, it is necessary to make settings on site to increase airflow.
 *2 Use air-blocking materials (CZ-CFU3) to completely block two discharge outlets for 2-way airflow.

Econavi panel is added into the line up

Continue Conventional function (Energy saving & comfort) and following are newly added.
 • Energy saving function: comfortable energy saving based on temperature and humidity

- New circulate function that improves comfort
- Movement detection is improved improving comfort

Econavi energy saving function

Newly put humidity sensor on air suction part, and achieve more comfort and energy saving operation.
 • Energy saving operation in case of low humidity during cooling operation

- Energy saving operation in case of high humidity during heating operation
- Energy saving operation based on activity amount and comfort and energy saving based on temperature and humidity.

Panels & Panel parts

Normal panel: CZ-KPU3H
 Econavi panel: CZ-KPU3A



nanoe X Generator Mark 3

nanoe™ X contains plenty of OH radicals that have outstanding effects on various air pollutants, including bacteria and viruses, mould, allergens, pollen, hazardous substances, as well as deodorise odours. It also keeps moisture in your skin and hair.



U2_{TYPE} 4-WAY Cassette

Model Name		S-22MU2E5BN	S-28MU2E5BN	S-36MU2E5BN	S-45MU2E5BN	S-56MU2E5BN	
Power source		220/230/240 V, 1 phase - 50Hz/60Hz					
Cooling capacity	kW	2.2	2.8	3.6	4.5	5.6	
	BTU/h	7,500	9,600	12,300	15,400	19,100	
Heating capacity	kW	2.5	3.2	4.2	5.0	6.3	
	BTU/h	8,500	10,900	14,300	17,100	21,500	
Power input	Cooling kW	0.020/0.020/0.020	0.020/0.020/0.020	0.020/0.020/0.020	0.020/0.020/0.020	0.025/0.025/0.025	
	Heating kW	0.020/0.020/0.020	0.020/0.020/0.020	0.020/0.020/0.020	0.020/0.020/0.020	0.025/0.025/0.025	
Running current	Cooling A	0.21/0.21/0.20	0.21/0.21/0.20	0.21/0.21/0.20	0.21/0.21/0.20	0.24/0.23/0.22	
	Heating A	0.20/0.20/0.19	0.20/0.20/0.19	0.20/0.20/0.19	0.20/0.20/0.19	0.23/0.22/0.21	
Fan	Type	Turbo fan	Turbo fan	Turbo fan	Turbo fan	Turbo fan	
	Air flow rate (H/M/L)	m³/h	768/726/690	768/726/690	870/780/690	930/780/690	990/810/690
		L/s	213/202/192	213/202/192	242/217/192	258/217/192	275/225/192
Motor output	kW	0.06	0.06	0.06	0.06	0.06	
Sound power level (H/M/L)	dB	45/44/43	45/44/43	45/44/43	46/44/43	47/45/43	
Sound pressure level (H/M/L)	dB(A)	30/29/28	30/29/28	30/29/28	31/29/28	32/30/28	
Dimensions* H x W x D	mm	256+(33.5) x 840 (950) x 840 (950)					
Pipe connections	Liquid	mm (inches)	Ø6.35 (Ø1/4)	Ø6.35 (Ø1/4)	Ø6.35 (Ø1/4)	Ø6.35 (Ø1/4)	
	Gas	mm (inches)	Ø12.7 (Ø1/2)	Ø12.7 (Ø1/2)	Ø12.7 (Ø1/2)	Ø12.7 (Ø1/2)	
Drain piping			VP-25	VP-25	VP-25	VP-25	
Net weight* (Panel)	kg	19 (+5)	19 (+5)	19 (+5)	19 (+5)	19 (+5)	

Global remarks	Rated conditions:	
	Cooling	Heating
	Indoor air temperature	27°C DB / 19°C WB
Outdoor air temperature	35°C DB / 24°C WB	7°C DB / 6°C WB

* The values in () for external dimensions and Net weight are the values for the optional ceiling panel.
In the case of nanoe X OFF Specifications are subject to change without notice.

S-60MU2E5BN	S-73MU2E5BN	S-90MU2E5BN	S-112MU2E5BN	S-140MU2E5BN	S-160MU2E5BN
220/230/240 V, 1 phase - 50Hz/60Hz					
6.0	7.3	9.0	11.2	14.0	16.0
20,500	24,900	30,700	38,200	47,800	54,600
7.1	8.0	10.0	14.0	16.0	18.0
24,200	27,300	34,100	47,800	54,600	61,400
0.035/0.035/0.035	0.040/0.040/0.040	0.040/0.040/0.040	0.095/0.095/0.095	0.095/0.095/0.095	0.105/0.105/0.105
0.035/0.035/0.035	0.040/0.040/0.040	0.040/0.040/0.040	0.090/0.090/0.090	0.090/0.090/0.090	0.100/0.100/0.100
0.34/0.33/0.32	0.37/0.36/0.35	0.39/0.38/0.37	0.77/0.74/0.71	0.77/0.74/0.71	0.85/0.82/0.79
0.33/0.32/0.31	0.36/0.35/0.34	0.38/0.37/0.36	0.75/0.72/0.69	0.75/0.72/0.69	0.83/0.80/0.77
Turbo fan	Turbo fan	Turbo fan	Turbo fan	Turbo fan	Turbo fan
1,260/960/780	1,350/960/780	1,380/1,110/840	2,160/1,560/1,200	2,160/1,560/1,200	2,220/1,680/1,440
350/267/217	375/267/217	383/308/233	600/433/333	600/433/333	617/467/400
0.06	0.06	0.06	0.09	0.09	0.09
51/47/44	52/47/44	53/50/47	60/54/50	60/54/50	61/55/53
36/32/29	37/32/29	38/35/32	45/39/35	45/39/35	46/40/38
319+(33.5) x 840 (950) x 840 (950)					
Ø9.52 (Ø3/8)	Ø9.52 (Ø3/8)	Ø9.52 (Ø3/8)	Ø9.52 (Ø3/8)	Ø9.52 (Ø3/8)	Ø9.52 (Ø3/8)
Ø15.88 (Ø5/8)	Ø15.88 (Ø5/8)	Ø15.88 (Ø5/8)	Ø15.88 (Ø5/8)	Ø15.88 (Ø5/8)	Ø15.88 (Ø5/8)
VP-25	VP-25	VP-25	VP-25	VP-25	VP-25
20 (+5)	20 (+5)	20 (+5)	25 (+5)	25 (+5)	25 (+5)

Standard Equipped nanoe™ Technology

- nanoe™ X, charged water particles, contain hydroxyl radical [OH radical] that work to provide quality air.
- The electrodes of nanoe™ X devices are made of titanium and electricity discharge into the water particles of nanoe™. So no need to clean or replace the device (maintenance free without wear).



Craftsmanship in Japan enables the adoption of titanium

Electrodes of nanoe™ X devices are produced with the support of craftsmen in Japan that has advanced expertise on processing ultra-small parts of titanium glass frames although titanium is very strong material and difficult to process.



nanoe™ X module

Unique nanoe™ X module casing releases 48 trillion hydroxyl radical (OH radical) per second.



nanoe™ X device

U2 TYPE 4-WAY CASSETTE Dimensions

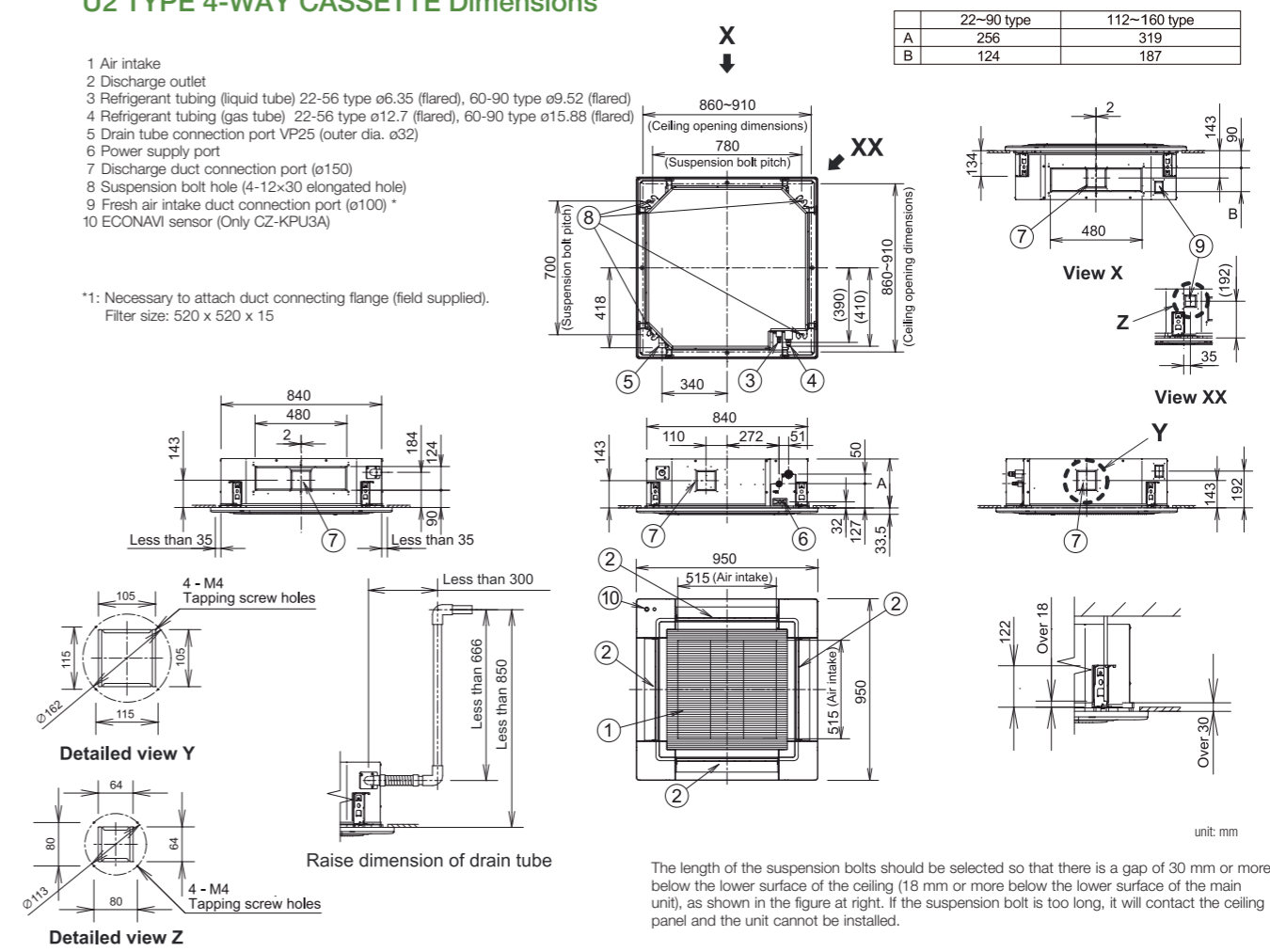

U2 TYPE 4-WAY Cassette

Semi concealed cassette

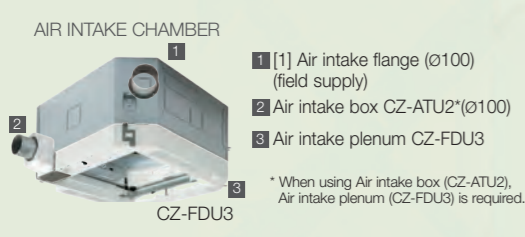

NEW PANEL DESIGN
Flat design, well-matched with interior, building.



Optional accessory



Technical focus

- New high performance turbo fan, new path system for heat exchanger
- Lower noise in slow fan operation
- Industry top light weight, easy piping
- Easy installation structure of the panel
- Econavi : Floor temperature and human sensor added. Activity amount detection and new circulator
- nanoe™ X : 20x for CAC (20 times more nanoe™ particle for wide commercial space). Inside cleaning by 20x nanoe™ + dry control

Flat horizontal design

The horizontal design of 4-way cassette achieves an elegant designed panel. Its slim design allow to protrude 33.5 mm from the ceiling.



Drain pump of up to 850 mm from the ceiling surface

Built in drain pump allows flexible install and design options with up to 850 mm lift. Long horizontal piping is also possible.

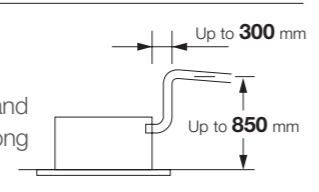

Easy to clean suction grille

Suction grille is able to make 90-degree turns.

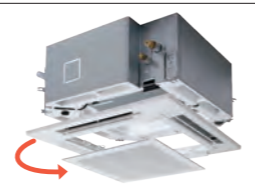

360° wide & comfortable airflow

Comfort air flow control and proper energy use. Flexible Air Flow direction control by individual flap control:
-4 Flaps can be controlled individually (by standard wired remote controller*)
-Versatile air flow control to cover a wide variety of demands.

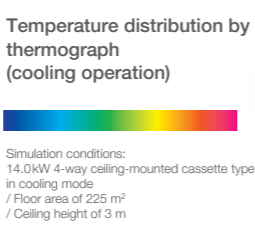
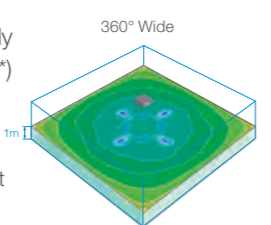

Ample airflow: 36 m³/min

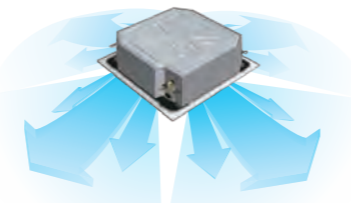

*Pre-setting is required for this function at System Test-run procedure

*Pre-setting is required for this function at System Test-run procedure

Model Name		S-22MU2E5B	S-28MU2E5B	S-36MU2E5B	S-45MU2E5B	S-56MU2E5B	
Power source		220/230/240 V, 1 phase - 50Hz/60Hz					
Cooling capacity	kW	2.2	2.8	3.6	4.5	5.6	
	BTU/h	7,500	9,600	12,300	15,400	19,100	
Heating capacity	kW	2.5	3.2	4.2	5.0	6.3	
	BTU/h	8,500	10,900	14,300	17,100	21,500	
Power input	Cooling kW	0.020/0.020/0.020	0.020/0.020/0.020	0.020/0.020/0.020	0.020/0.020/0.020	0.025/0.025/0.025	
	Heating kW	0.020/0.020/0.020	0.020/0.020/0.020	0.020/0.020/0.020	0.020/0.020/0.020	0.025/0.025/0.025	
Running current	Cooling A	0.21/0.21/0.20	0.21/0.21/0.20	0.21/0.21/0.20	0.21/0.21/0.20	0.24/0.23/0.22	
	Heating A	0.20/0.20/0.19	0.20/0.20/0.19	0.20/0.20/0.19	0.20/0.20/0.19	0.23/0.22/0.21	
Fan	Type	Turbo fan					
	Air flow rate (H/M/L)	m³/h	870/780/690	870/780/690	870/780/690	930/780/690	990/810/690
		L/s	242/217/192	242/217/192	242/217/192	258/217/192	275/225/192
	Motor output	kW					
Sound power level (H/M/L)	dB	45/44/43	45/44/43	45/44/43	46/44/43	47/45/43	
Sound pressure level (H/M/L)	dB(A)	30/29/28	30/29/28	30/29/28	31/29/28	32/30/28	
Dimensions* H x W x D	mm	256+(33.5) x 840 (950) x 840 (950)					
Pipe connections	Liquid	mm (inches)					
	Gas	mm (inches)					
	Drain piping	VP-25					
Net weight* (Panel)	kg	19 (+5)	19 (+5)	19 (+5)	19 (+5)	19 (+5)	

High-ceiling installation (Up to 5 m for 10.6 kW and higher capacity models)

The units can be installed in rooms with high ceilings, where they provide ample floor-level heating in the winter. (See ceiling height guidelines below.)

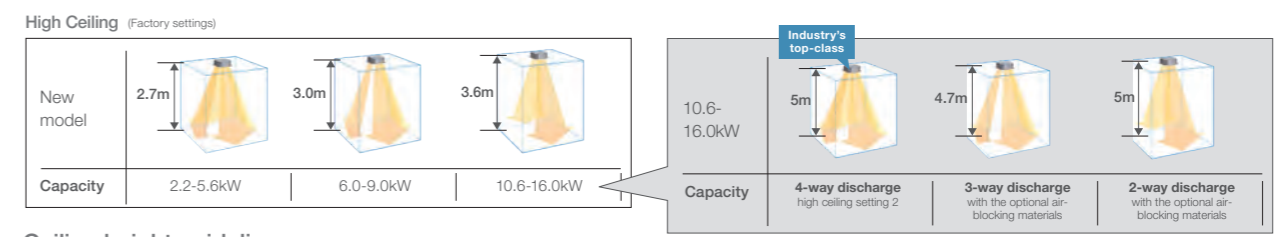

Ceiling height guidelines

Indoor unit	4-way discharge			3-way discharge (optional air-blocking materials)	2-way discharge (optional air-blocking materials) *2
	Factory setting 1	High ceiling setting 1	High ceiling setting 2		
2.2-5.6kW	2.7	3.2	3.5	3.8	4.2
6.0-9.0kW	3.0	3.3	3.6	3.8	4.2
10.6-16.0kW	3.6	4.3	5.0	4.7	5.0

*1 When using the unit in a configuration other than the factory settings, it is necessary to make settings on site to increase airflow.
*2 Use air-blocking materials (CZ-CFU3) to completely block two discharge outlets for 2-way airflow.

nanoe X Generator Mark 2

nanoe™ X contains plenty of OH radicals that have outstanding effects on various air pollutants, including bacteria and viruses, mould, allergens, hazardous substances, as well as deodorise odours. It also keeps moisture in your skin and hair.



S-60MU2E5B	S-73MU2E5B	S-90MU2E5B	S-106MU2E5B	S-140MU2E5B	S-160MU2E5B
220/230/240 V, 1 phase - 50Hz/60Hz					
6.0	7.3	9.0	10.6	14.0	16.0
20,500	24,900	30,700	36,200	47,800	54,600
7.1	8.0	10.0	11.4	16.0	18.0
24,200	27,300	34,100	38,900	54,600	61,400
0.035/0.035/0.035	0.040/0.040/0.040	0.040/0.040/0.040	0.090/0.090/0.090	0.095/0.095/0.095	0.105/0.105/0.105
0.035/0.035/0.035	0.040/0.040/0.040	0.040/0.040/0.040	0.085/0.085/0.085	0.090/0.090/0.090	0.100/0.100/0.100
0.34/0.33/0.32	0.37/0.36/0.35	0.39/0.38/0.37	0.74/0.71/0.68	0.77/0.74/0.71	0.85/0.82/0.79
0.33/0.32/0.31	0.36/0.35/0.34	0.38/0.37/0.36	0.72/0.69/0.66	0.75/0.72/0.69	0.83/0.80/0.77
Turbo fan	Turbo fan	Turbo fan	Turbo fan	Turbo fan	Turbo fan
1,260/960/780	1,350/960/780	1,380/1,110/840	2,040/1,500/1,140	2,160/1,560/1,200	2,220/1,680/1,440
350/267/217	375/267/217	383/308/233	567/417/317	600/433/333	617/467/400
0.06	0.06	0.06	0.09	0.09	0.09
51/47/44	52/47/44	53/50/47	59/53/49	60/54/50	61/55/53
36/32/29	37/32/29	38/35/32	44/38/34	45/39/35	46/40/38
319+(33.5) x 840 (950) x 840 (950)					
Ø9.52 (Ø3/8)	Ø9.52 (Ø3/8)	Ø9.52 (Ø3/8)	Ø9.52 (Ø3/8)	Ø9.52 (Ø3/8)	Ø9.52 (Ø3/8)
Ø15.88 (Ø5/8)	Ø15.88 (Ø5/8)	Ø15.88 (Ø5/8)	Ø15.88 (Ø5/8)	Ø15.88 (Ø5/8)	Ø15.88 (Ø5/8)
VP-25	VP-25	VP-25	VP-25	VP-25	VP-25
20 (+5)	20 (+5)	20 (+5)	25 (+5)	25 (+5)	25 (+5)

Global remarks

Rated conditions:
Cooling
Indoor air temperature 27°C DB / 19°C WB
Outdoor air temperature 35°C DB / 24°C WB

Rated conditions:
Heating
Indoor air temperature 20°C DB
Outdoor air temperature 7°C DB / 6°C WB

* The values in () for external dimensions and Net weight are the values for the optional ceiling panel. In the case of nanoe X OFF Specifications are subject to change without notice.

Y3 TYPE 4-Way Mini Cassette

Mini semi concealed cassette



Designed to fit perfectly into a 60 x 60 cm ceiling grid without the need to alter the bar configuration, the Y3 is ideal for small commercial and retrofit applications. In addition, improvements to the Y3's efficiency make this model one of the most advanced units in the industry.



nanoe™ X
Generator Mark3



Please refer to the nanoe™ X website for the Mark 3 information.



Optional accessory

ECONAVI
ECONAVI ready

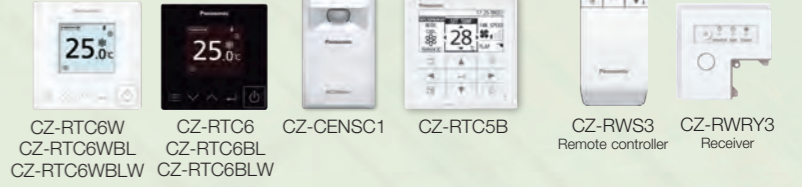

Technical focus

- Mini cassette fits into a 60 x 60 cm ceiling grid
- Powerful drain pump gives 850 mm lift
- Multi-directional air flow
- Easy installation
- DC fan motor with variable speed and a new heat exchanger ensures efficient power consumption
- nanoe™ X : 100x for CAC (100 times more nanoe™ particle for wide commercial space). Inside cleaning by 100x nanoe™ + dry control

Compact design

Thanks to advanced Panasonic design the panel is a compact 625 x 625 mm, offering elegant, unobtrusive installation even where space is limited.

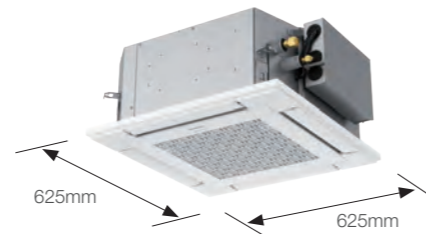

Lighter and slimmer, easier installation

When only 230 mm of indoor body height, it can easily fit in limited spaces and tight spots. (Required 243 mm from bottom of panel to top of the unit)

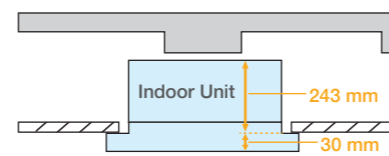

Individual flap control

Keep everyone comfortable by directing air where it's needed and away from where it isn't with individual flap control.



A drain height of up to 850 mm from the ceiling surface

The internal pump allows the drain pipe to be elevated up to 850 mm above the base of the unit.

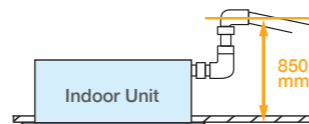

Model Name		S-22MY3E	S-28MY3E	S-36MY3E	S-45MY3E	S-56MY3E
Power source		220/230/240 V, 1 phase - 50Hz/60Hz				
Cooling capacity	kW	2.2	2.8	3.6	4.5	5.6
	BTU/h	7,500	9,600	12,300	15,400	19,100
Heating capacity	kW	2.5	3.2	4.2	5.0	6.3
	BTU/h	8,500	10,900	14,300	17,100	21,500
Power input	Cooling kW	0.020	0.021	0.022	0.030	0.042
	Heating kW	0.018	0.019	0.020	0.028	0.040
Running amperes	Cooling A	0.25 0.24 0.23	0.26 0.25 0.24	0.27 0.26 0.25	0.35 0.34 0.33	0.44 0.43 0.42
	Heating A	0.22 0.21 0.20	0.23 0.22 0.21	0.24 0.23 0.22	0.32 0.31 0.30	0.41 0.40 0.39
Fan motor	Type	Turbo fan				
	Airflow rate (H/M/L) m³/h	522/420/360	540/450/360	570/468/360	690/540/390	810/630/480
	(H/M/L) L/s	145/117/100	150/125/100	158/130/100	192/150/108	225/175/133
	Output kW	0.03	0.03	0.03	0.03	0.03
Sound power level (H/M/L)	Cooling dB	48/45/43	49/45/43	50/46/43	54/49/45	57/52/48
	Heating dB	48/45/43	49/45/43	50/46/43	54/49/45	57/52/48
Sound pressure level (H/M/L)	Cooling dB(A)	33/30/28	34/30/28	35/31/28	39/34/30	42/37/33
	Heating dB(A)	33/30/28	34/30/28	35/31/28	39/34/30	42/37/33
Dimensions* H x W x D mm		243(+30) x 575(625) x 575(625)	243(+30) x 575(625) x 575(625)	243(+30) x 575(625) x 575(625)	243(+30) x 575(625) x 575(625)	243(+30) x 575(625) x 575(625)
	Liquid mm (inches)	Ø6.35 (Ø1/4)	Ø6.35 (Ø1/4)	Ø6.35 (Ø1/4)	Ø6.35 (Ø1/4)	Ø6.35 (Ø1/4)
Pipe connections	Gas mm (inches)	Ø12.7 (Ø1/2)	Ø12.7 (Ø1/2)	Ø12.7 (Ø1/2)	Ø12.7 (Ø1/2)	Ø12.7 (Ø1/2)
	Drain piping	VP-20	VP-20	VP-20	VP-20	VP-20
Net weight* kg		15(+2.8)	15(+2.8)	15(+2.8)	15(+2.8)	15(+2.8)

Global remarks	Rated conditions:	Cooling	Heating
	Indoor air temperature	27°C DB / 19°C WB	20°C DB / 15°C WB
	Outdoor air temperature	35°C DB / 24°C WB	7°C DB / 6°C WB

* The values in () for external dimensions and Net weight are the values for the optional ceiling panel. Specifications are subject to change without notice.

Y3 TYPE 4-WAY MINI CASSETTE Dimensions

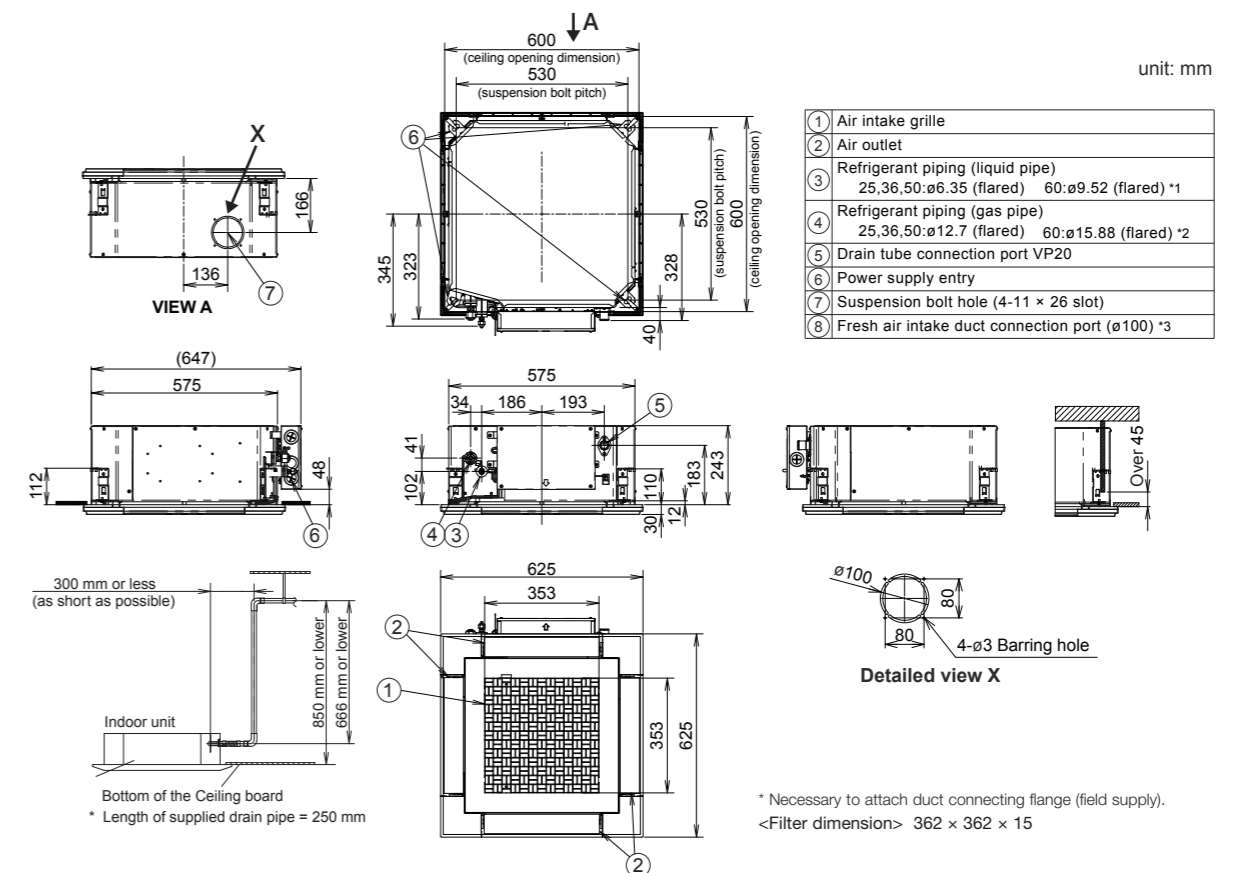

Y2^{TYPE} 4-WAY Mini Cassette

Mini semi concealed cassette



Technical focus

- Mini cassette fits into a 60 x 60cm ceiling grid
- DC fan motor with variable speed and a new heat exchanger ensures efficient power consumption
- Fresh air knock out
- Multi directional air flow

Compact design

The panel is a compact (70x70cm) so it can be installed even in a small room where space is limited.

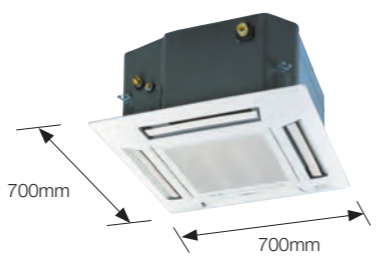

Lighter and slimmer, easier installation

When only 260mm of indoor body height, it can easily fit in limited spaces and tight spots. (Required 288mm from bottom of panel to top of the unit)

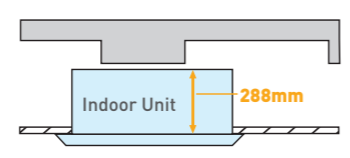

A drain height of up to 750 mm from the ceiling surface

The internal pump allows the drain pipe to be elevated up to 750mm above the base of the unit.

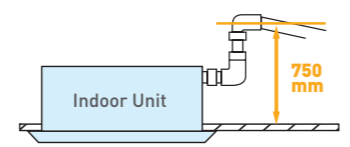

Model Name	S-22MY2E5A	S-28MY2E5A	S-36MY2E5A	S-45MY2E5A	S-56MY2E5A		
Power source	220/230/240 V, 1 phase - 50, 60 Hz						
Cooling capacity	kW	2.2	2.8	3.6	4.5	5.6	
	BTU/h	7,500	9,600	12,300	15,400	19,100	
Heating capacity	kW	2.5	3.2	4.2	5.0	6.3	
	BTU/h	8,500	10,900	14,300	17,100	21,500	
Power input	Cooling kW	0.035	0.035	0.040	0.040	0.045	
	Heating kW	0.030	0.030	0.035	0.035	0.040	
Running amperes	Cooling A	0.30	0.30	0.30	0.32	0.35	
	Heating A	0.25	0.30	0.30	0.30	0.35	
Fan motor	Type	Turbo fan	Turbo fan	Turbo fan	Turbo fan	Turbo fan	
	Airflow rate (H/M/L)	m³/h	546/492/336	558/504/336	582/522/360	600/558/492	624/588/510
	L/s	152/137/93	155/140/93	162/145/100	167/155/137	173/163/142	
	Output kW	0.04	0.04	0.04	0.04	0.04	
Sound power level (H/M/L)	Cooling dB	50/46/40	50/46/40	51/47/41	53/49/43	55/52/49	
	Heating dB	50/46/40	50/46/40	51/47/41	53/49/43	55/52/49	
Sound pressure level (H/M/L)	Cooling dB(A)	35/31/25	35/31/25	36/32/26	38/34/28	40/37/34	
	Heating dB(A)	35/31/25	35/31/25	36/32/26	38/34/28	40/37/34	
Dimensions*	H x W x D mm	288 (+31) x 575 (700) x 575 (700)	288 (+31) x 575 (700) x 575 (700)	288 (+31) x 575 (700) x 575 (700)	288 (+31) x 575 (700) x 575 (700)	288 (+31) x 575 (700) x 575 (700)	
	Liquid mm (inches)	Ø6.35 (Ø1/4)	Ø6.35 (Ø1/4)	Ø6.35 (Ø1/4)	Ø6.35 (Ø1/4)	Ø6.35 (Ø1/4)	
	Gas mm (inches)	Ø12.7 (Ø1/2)	Ø12.7 (Ø1/2)	Ø12.7 (Ø1/2)	Ø12.7 (Ø1/2)	Ø12.7 (Ø1/2)	
Pipe connections	Drain piping	VP-25	VP-25	VP-25	VP-25	VP-25	
	kg	18 (+2.4)	18 (+2.4)	18 (+2.4)	18 (+2.4)	18 (+2.4)	

* The values in () for external dimensions and Net weight are the values for the optional ceiling panel. Specifications are subject to change without notice.

Global remarks	Rated conditions:	Cooling	Heating
	Indoor air temperature	27°C DB / 19°C WB	20°C DB
	Outdoor air temperature	35°C DB / 24°C WB	7°C DB / 6°C WB

L1^{TYPE} 2-WAY Cassette

Optional accessory

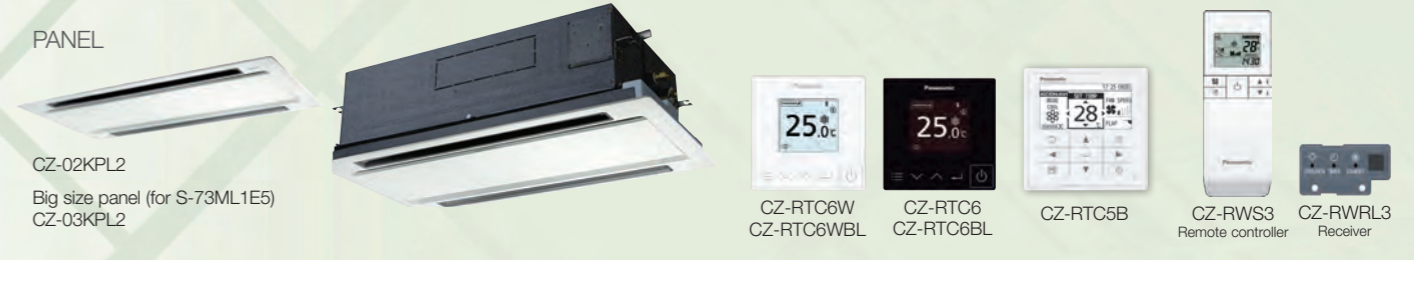

Technical focus

- Airflow and distribution is automatically altered depending on the operational mode of the unit
- Drain up is possible up to 500mm via the built-in drain pump
- Simple maintenance

Auto flap control

Airflow and distribution is automatically altered depending on the operational mode (cooling or heating) of the unit.

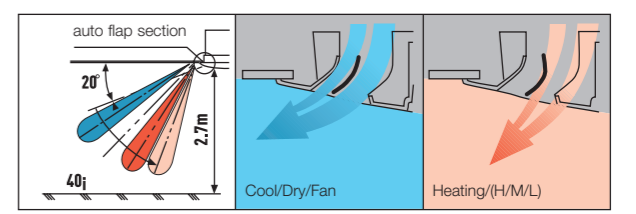

Drain up is possible up to 500mm via the built-in drain pump.

Maintenance of the drain pump is possible from both sides, from the left side (piping side) and from the inside of the unit.

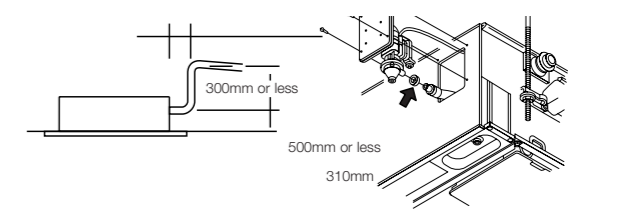

Simple maintenance

The drain pan is equipped with site wiring and can be removed. The fan case has a split construction, and the fan motor can be removed easily when the lower case is removed.

Model Name	S-22ML1E5	S-28ML1E5	S-36ML1E5	S-45ML1E5	S-56ML1E5	S-73ML1E5	
Power source	220/230/240V, 1 phase - 50 / 60Hz						
Cooling capacity	kW	2.2	2.8	3.6	4.5	5.6	7.3
	BTU/h	7,500	9,600	12,000	15,000	19,000	25,000
Heating capacity	kW	2.5	3.2	4.2	5.0	6.3	8.0
	BTU/h	8,500	11,000	14,000	17,000	21,000	27,000
Power input	Cooling kW	0.086/0.090/0.095	0.086/0.092/0.097	0.088/0.093/0.099	0.091/0.097/0.103	0.091/0.097/0.103	0.135/0.145/0.154
	Heating kW	0.055/0.058/0.062	0.055/0.060/0.064	0.057/0.061/0.066	0.060/0.065/0.070	0.060/0.065/0.070	0.100/0.109/0.117
Running current	Cooling A	0.45/0.45/0.45	0.44/0.45/0.45	0.44/0.45/0.45	0.45/0.45/0.45	0.45/0.45/0.45	0.64/0.65/0.66
	Heating A	0.29/0.29/0.30	0.28/0.29/0.30	0.28/0.29/0.30	0.29/0.29/0.30	0.29/0.29/0.30	0.46/0.48/0.49
Fan	Type	Sirocco fan	Sirocco fan	Sirocco fan	Sirocco fan	Sirocco fan	
	Air flow rate (H/M/L)	m³/h	480/420/360	540/480/420	580/520/460	660/540/480	660/540/480
	L/s	133/117/100	150/133/117	161/144/128	183/150/133	183/150/133	317/267/233
	Motor output kW	0.03	0.03	0.03	0.03	0.03	
Sound power level (H/M/L)	dB	40/38/35	44/40/37	45/42/39	46/44/40	46/44/40	49/46/44
Sound pressure level (H/M/L)	dB(A)	30/27/24	33/29/26	34/31/28	35/33/29	35/33/29	38/35/33
Dimensions*	H x W x D mm	350+80x840 (1,060)x600 (680)	350+80x840 (1,060)x600 (680)	350+80x840 (1,060)x600 (680)	350+80x840 (1,060)x600 (680)	350+80x840 (1,060)x600 (680)	350+80x1,140 (1,360)x600 (680)
	Liquid mm (inches)	Ø6.35 (Ø1/4)	Ø6.35 (Ø1/4)	Ø6.35 (Ø1/4)	Ø6.35 (Ø1/4)	Ø6.35 (Ø1/4)	Ø9.52 (Ø3/8)
	Gas mm (inches)	Ø12.7 (Ø1/2)	Ø12.7 (Ø1/2)	Ø12.7 (Ø1/2)	Ø12.7 (Ø1/2)	Ø12.7 (Ø1/2)	Ø15.88 (Ø5/8)
Pipe connections	Drain piping	VP-25	VP-25	VP-25	VP-25	VP-25	
	kg	23 (+5.5)	23 (+5.5)	23 (+5.5)	23 (+5.5)	23 (+5.5)	30 (+9)

* The values in () for external dimensions and Net weight are the values for the optional ceiling panel. Specifications are subject to change without notice.

Global remarks	Rated conditions:	Cooling	Heating
	Indoor air temperature	27°C DB / 19°C WB	20°C DB
	Outdoor air temperature	35°C DB / 24°C WB	7°C DB / 6°C WB

D1 TYPE 1-WAY Cassette



Semi concealed slim cassette



Optional accessory

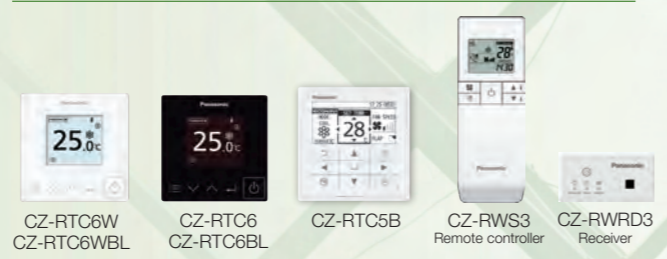

T2 TYPE Ceiling Mounted



Optional accessory



Technical focus

- Ultra-Slim profile
- Suitable for standard and high ceilings
- Built-in drain pump provides 590mm lift from ceiling
- Easy to install and maintain
- Hanging height can be easily adjusted
- Uses a DC fan motor to improve energy-efficiency

Drain height

A built-in drain pump provides up to 590mm lift from ceiling height for flexible install options.

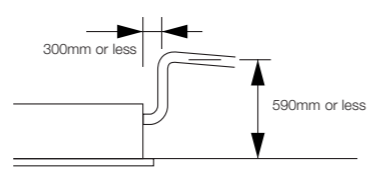

With 3 types of air-blow systems, the units can be used in various ways.



(1) One-direction "down-blow" system

Powerful one-direction "down-blow" system reaches the floor even from high ceilings (up to 4.2m).



(2) Two-direction ceiling-mounted system

"Down-blow" and "front-blow" systems are combined in a ceiling-mounted unit to blow air over a wide area.

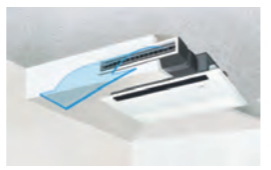

(3) One-direction ceiling-mounted system

This powerful ceiling-mounted "front-blow" system efficiently air-conditions the space in front of the unit. (Additional accessories required)

Model Name	S-28MD1E5	S-36MD1E5	S-45MD1E5	S-56MD1E5	S-73MD1E5	
Power source	220/230/240 V, 1 phase - 50 / 60 Hz					
Cooling capacity	2.8					
	9,600					
Heating capacity	3.2					
	11,000					
Power input	Cooling kW	0.050/0.051/0.052	0.050/0.051/0.052	0.050/0.051/0.052	0.058/0.060/0.061	
	Heating kW	0.039/0.040/0.042	0.039/0.040/0.042	0.039/0.040/0.042	0.046/0.048/0.049	0.075/0.076/0.077
Running current	Cooling A	0.40/0.39/0.39	0.40/0.39/0.39	0.40/0.39/0.39	0.46/0.46/0.46	
	Heating A	0.36/0.35/0.35	0.36/0.35/0.35	0.36/0.35/0.35	0.42/0.41/0.41	0.66/0.65/0.63
Fan	Type	Sirocco fan				
	Air flow rate (H/M/L) m³/h	720/600/540	720/600/540	720/660/600	780/690/600	1,080/900/780
	(H/M/L) L/s	200/167/150	200/167/150	200/183/167	217/192/167	300/250/217
	Motor output kW	0.05	0.05	0.05	0.05	0.05
Sound power level (H/M/L) dB	47/45/44					
	36/34/33					
Dimensions * H x W x D mm	200+(20) x 1,000 (1,230) x 710 (800)					
	200+(20) x 1,000 (1,230) x 710 (800)					
Pipe connections	Liquid mm (inches)	Ø6.35 (Ø1/4)	Ø6.35 (Ø1/4)	Ø6.35 (Ø1/4)	Ø6.35 (Ø1/4)	
	Gas mm (inches)	Ø12.7 (Ø1/2)	Ø12.7 (Ø1/2)	Ø12.7 (Ø1/2)	Ø12.7 (Ø1/2)	
Net weight * kg	21 (+5.5)					
	22 (+5.5)					

Global remarks	Rated conditions:	
	Cooling	Heating
	Indoor air temperature 27°C DB / 19°C WB	20°C DB
Outdoor air temperature 35°C DB / 24°C WB	7°C DB / 6°C WB	

* The values in () for external dimensions and Net weight are the values for the optional ceiling panel. Specifications are subject to change without notice.

Technical focus

- Lower sound levels
- Standardised height and depth for all models
- Long and wide air distribution
- Easy to install and maintain
- Fresh air knockout

Energy-saving technology Delivering top-class efficiency

Optimization of the shape of the casing and fan assures bigger air flow and higher efficiency. Energy-saving performance is top class in the industry.

Top Class Energy Saving

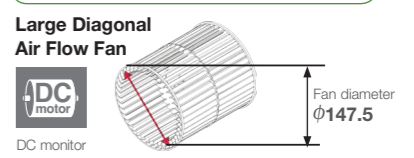

Comfortable, long-distance air flow distribution

The shape of the outlet has been optimized to provide long-distance air flow distribution. Even in deep spaces, air flow reaches every corner for exceptionally comfortable air conditioning.

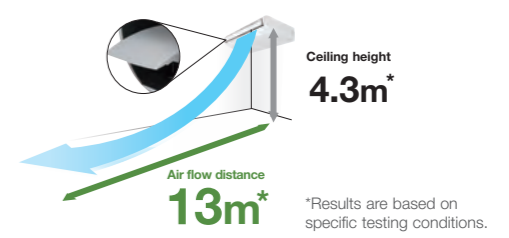

High Ceiling Setting	Air flow distance
*Setting by remote control	140
4.3m	13m

Multiple piping directions for flexible installation

The 5-directional drain pipe and 3-directional refrigerant pipe make installation much easier. And the neat fit with walls and ceilings assures more installation flexibility.

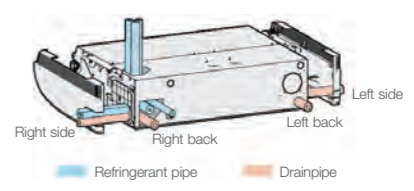

Model Name	S-36MT2E5A	S-45MT2E5A	S-56MT2E5A	S-73MT2E5A	S-106MT2E5A	S-140MT2E5A	
Power source	220 / 230 / 240 V, 1 phase - 50 / 60 Hz						
Cooling capacity	3.6						
	12,300						
Heating capacity	4.2						
	14,300						
Power input	Cooling kW	0.035/0.035/0.035	0.040/0.040/0.040	0.040/0.040/0.040	0.055/0.055/0.055	0.080/0.080/0.080	
	Heating kW	0.035/0.035/0.035	0.040/0.040/0.040	0.040/0.040/0.040	0.055/0.055/0.055	0.080/0.080/0.080	
Running current	Cooling A	0.37/0.36/0.35	0.39/0.38/0.37	0.39/0.38/0.37	0.45/0.44/0.43	0.69/0.67/0.65	
	Heating A	0.37/0.36/0.35	0.39/0.38/0.37	0.39/0.38/0.37	0.45/0.44/0.43	0.69/0.67/0.65	
Fan	Type	Sirocco fan					
	Air flow rate (H/M/L) m³/h	840/720/630	900/750/630	900/750/630	1,260/1,080/930	1,800/1,500/1,380	
	(H/M/L) L/s	233/200/175	250/208/175	250/208/175	350/300/258	500/417/383	
	Motor output kW	0.043	0.043	0.043	0.074	0.111	
Sound power level (H/M/L) dB	54/50/48						
	36/32/30						
Dimensions H x W x D mm	235 x 960 x 690						
	235 x 960 x 690						
Pipe connections	Liquid mm (inches)	Ø6.35 (Ø1/4)	Ø6.35 (Ø1/4)	Ø6.35 (Ø1/4)	Ø9.52 (Ø3/8)	Ø9.52 (Ø3/8)	
	Gas mm (inches)	Ø12.7 (Ø1/2)	Ø12.7 (Ø1/2)	Ø12.7 (Ø1/2)	Ø15.88 (Ø5/8)	Ø15.88 (Ø5/8)	
Net weight kg	27						
	27						

Global remarks	Rated conditions:	
	Cooling	Heating
	Indoor air temperature 27°C DB / 19°C WB	20°C DB
Outdoor air temperature 35°C DB / 24°C WB	7°C DB / 6°C WB	

Specifications are subject to change without notice.

P1 TYPE Floor Standing

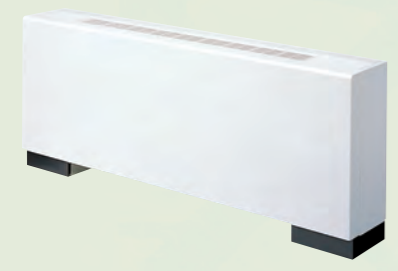

Optional accessory



R1 TYPE Concealed Floor Standing



Optional accessory



Technical focus

- Pipes can be connected to either side of the unit from the bottom or rear
- Easy to install
- Front panel opens fully for easy maintenance
- Removable air discharge grille gives flexible air flow

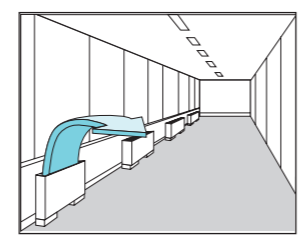

Effective perimeter air conditioning

A wired remote control (CZ-RTC4/CZ-RTC5B) can be installed in the body

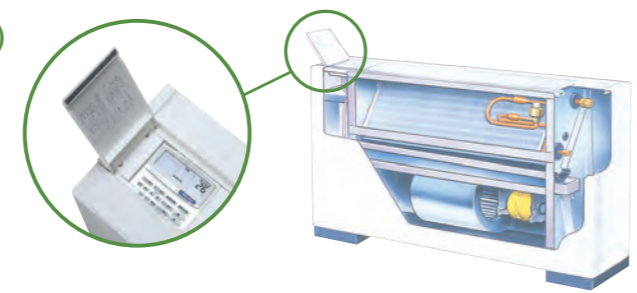

Model Name		S-22MP1E5	S-28MP1E5	S-36MP1E5	S-45MP1E5	S-56MP1E5	S-71MP1E5	
Power source		220/230/240 V, 1 phase - 50 / 60 Hz						
Cooling capacity	kW	2.2	2.8	3.6	4.5	5.6	7.1	
	BTU/h	7,500	9,600	12,000	15,000	19,000	24,000	
Heating capacity	kW	2.5	3.2	4.2	5.0	6.3	8.0	
	BTU/h	8,500	11,000	14,000	17,000	21,000	27,000	
Power input	Cooling kW	0.051/0.056/0.061	0.051/0.056/0.061	0.079/0.085/0.091	0.116/0.126/0.136	0.116/0.126/0.136	0.150/0.160/0.170	
	Heating kW	0.036/0.040/0.045	0.036/0.040/0.045	0.064/0.070/0.076	0.079/0.091/0.101	0.079/0.091/0.101	0.110/0.120/0.130	
Running current	Cooling A	0.24/0.25/0.26	0.24/0.25/0.26	0.37/0.38/0.39	0.54/0.56/0.58	0.54/0.56/0.58	0.70/0.72/0.73	
	Heating A	0.17/0.18/0.19	0.17/0.18/0.19	0.30/0.31/0.32	0.37/0.41/0.43	0.37/0.41/0.43	0.52/0.54/0.56	
Fan	Type	Sirocco fan						
	Air flow rate (H/M/L)	m ³ /h	420/360/300	420/360/300	540/420/360	720/540/480	900/780/660	1,020/840/720
		L/s	117/100/83	117/100/83	150/117/100	200/150/133	250/217/183	283/233/200
	Motor output kW	0.01	0.01	0.02	0.02	0.03	0.06	
Sound power level (H/M/L)	dB	44/41/39	44/41/39	50/46/40	49/46/42	50/47/42	52/49/46	
Sound pressure level (H/M/L)	dB(A)	33/30/28	33/30/28	39/35/29	38/35/31	39/36/31	41/38/35	
Dimensions	H x W x D	615 x 1,065 x 230	615 x 1,065 x 230	615 x 1,065 x 230	615 x 1,380 x 230	615 x 1,380 x 230	615 x 1,380 x 230	
	Liquid	mm (inches)	Ø6.35 (Ø1/4)	Ø6.35 (Ø1/4)	Ø6.35 (Ø1/4)	Ø6.35 (Ø1/4)	Ø6.35 (Ø1/4)	Ø9.52 (Ø3/8)
	Gas	mm (inches)	Ø12.7 (Ø1/2)	Ø12.7 (Ø1/2)	Ø12.7 (Ø1/2)	Ø12.7 (Ø1/2)	Ø12.7 (Ø1/2)	Ø15.88 (Ø5/8)
Pipe connections	Drain piping	VP-20						
Net weight	kg	29	29	29	39	39	39	

Global remarks	Rated conditions:	Cooling	Heating
	Indoor air temperature	27°C DB / 19°C WB	20°C DB
	Outdoor air temperature	35°C DB / 24°C WB	7°C DB / 6°C WB

Specifications are subject to change without notice.

Technical focus

- Chassis unit for discrete customisable installation
- Complete with removable filters
- Pipes can be connected to the unit either from the bottom or rear
- Easy to install

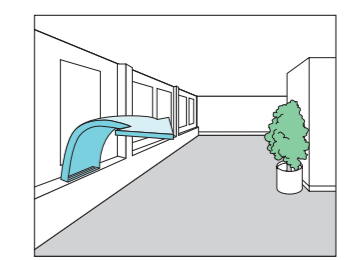

Perimeter air conditioning with high interior quality

Model Name		S-22MR1E5	S-28MR1E5	S-36MR1E5	S-45MR1E5	S-56MR1E5	S-71MR1E5	
Power source		220/230/240 V, 1 phase - 50, 60 Hz						
Cooling capacity	kW	2.2	2.8	3.6	4.5	5.6	7.1	
	BTU/h	7,500	9,600	12,000	15,000	19,000	24,000	
Heating capacity	kW	2.5	3.2	4.2	5.0	6.3	8.0	
	BTU/h	8,500	11,000	14,000	17,000	21,000	27,000	
Power input	Cooling kW	0.051/0.056/0.061	0.051/0.056/0.061	0.079/0.085/0.091	0.116/0.126/0.136	0.116/0.126/0.136	0.150/0.160/0.170	
	Heating kW	0.036/0.040/0.045	0.036/0.040/0.045	0.064/0.070/0.076	0.079/0.091/0.101	0.079/0.091/0.101	0.110/0.120/0.130	
Running current	Cooling A	0.24/0.25/0.26	0.24/0.25/0.26	0.37/0.38/0.39	0.54/0.56/0.58	0.54/0.56/0.58	0.70/0.72/0.73	
	Heating A	0.17/0.18/0.19	0.17/0.18/0.19	0.30/0.31/0.32	0.37/0.41/0.43	0.37/0.41/0.43	0.52/0.54/0.56	
Fan	Type	Sirocco fan						
	Air flow rate (H/M/L)	m ³ /h	420/360/300	420/360/300	540/420/360	720/540/480	900/780/660	1,020/840/720
		L/s	117/100/83	117/100/83	150/117/100	200/150/133	250/217/183	283/233/200
	Motor output kW	0.01	0.01	0.02	0.02	0.03	0.06	
Sound power level (H/M/L)	dB	44/41/39	44/41/39	50/46/40	49/46/42	49/46/42	52/49/46	
Sound pressure level (H/M/L)	dB(A)	33/30/28	33/30/28	39/35/29	38/35/31	39/36/31	41/38/35	
Dimensions	H x W x D	616 x 904 x 229	616 x 904 x 229	616 x 904 x 229	616 x 1,219 x 229	616 x 1,219 x 229	616 x 1,219 x 229	
	Liquid	mm (inches)	Ø6.35 (Ø1/4)	Ø6.35 (Ø1/4)	Ø6.35 (Ø1/4)	Ø6.35 (Ø1/4)	Ø6.35 (Ø1/4)	Ø9.52 (Ø3/8)
	Gas 410 A	mm (inches)	Ø12.7 (Ø1/2)	Ø12.7 (Ø1/2)	Ø12.7 (Ø1/2)	Ø12.7 (Ø1/2)	Ø12.7 (Ø1/2)	Ø15.88 (Ø5/8)
Pipe connections	Drain piping	VP-20						
Net weight	kg	21	21	21	28	28	28	

Global remarks	Rated conditions:	Cooling	Heating
	Indoor air temperature	27°C DB / 19°C WB	20°C DB
	Outdoor air temperature	35°C DB / 24°C WB	7°C DB / 6°C WB

Specifications are subject to change without notice.

Smart Connectivity and Control Solutions

Panasonic offers a range of smart connectivity and control solutions for residential and commercial applications that allows you to conveniently manage and monitor air conditioning units in single or multiple locations from one mobile device.



For Residential

Panasonic Comfort Cloud

Personal Control Solutions Panasonic Comfort Cloud

- Remotely manage and monitor multiple air conditioning units in your home
- Easily control and access all features of the air conditioning units with smart centralised control.

CZ-CAPWFC1
Network adaptor. Available for all types of VRF indoor units.

**CZ-RTC6WBLW
CZ-RTC6BLW**
WLAN remote controller
*Available for particular types of VRF indoor units. Please consult with Panasonic sales engineers.

For Light Commercial

Panasonic Comfort Cloud VRF Smart Connectivity+

Cost effective Energy Management Solution



- Multiple location control at your convenience with Comfort Cloud
- Gain control of multiple zones and sites intuitively adjusting temperature by areas with differentiated user rights settings.
- Indoor Air Quality (IAQ) and efficient energy usage with VRF Smart Connectivity+
- Ultimate cooling comfort with sensing technology and automatic IAQ control.
 - Simplified Plug & Play installation with BMS connection for better energy consumption.

Wide Range of Smart Control Solutions for All Needs

Whether you need to control multiple sites, a single office, or your home, we offer a range of innovative smart control solutions for a variety of needs.

Panasonic Comfort Cloud

Intuitive and scalable air conditioning control solution using a personal mobile device.

VRF Smart Connectivity+

Offers efficient energy management with high indoor air quality (IAQ) control.

Panasonic AC Smart Cloud

Monitor and manage energy consumption of multiple location through a cloud computing system.

For Multiple Building Management

Panasonic AC Smart Cloud

Full Control of All Installations From A Single Internet Connection Panasonic AC Smart Cloud

- Manage and monitor energy consumption patterns
- Analyse energy usage, running time and optimise temperatures to reduce energy costs.
- Centralised control solution with zero downtime
- Receive real-time status updates to prevent breakdowns.
- Flexible and scalable solution for expanding businesses and multi sites
- Adaptable solutions that can easily be upgraded for new features, meet user demand and better IT management.

Panasonic Comfort Cloud

Control air conditioning units from wherever and whenever with your smartphone, by using Panasonic Comfort Cloud and WLAN smart adaptor. This scalable solution is ideal for one system, one site or multiple locations. Coupling the adaptor with the already feature rich systems, makes it an ideal solution for both residential and commercial applications.



For Residential

Remotely manage and monitor air conditioning units from anywhere anytime.

For Light Commercial

Gain control of multiple zones and sites intuitively up to 200 indoor units.

Panasonic Comfort Cloud features

From 1 to 200 units

User can control up to 200 indoor units. 10 different sites, with up to 20 units / groups per site.



Multiple User

The Panasonic Comfort Cloud App allows multiuser access control. Restrict user access to specific units.



Easy Scheduling

Complex weekly scheduling made simple. Not only for one units, but across multiple sites and from a smartphone.



Error Codes

Error code notification through the App, provides early notification and allows for faster repair.



Application examples

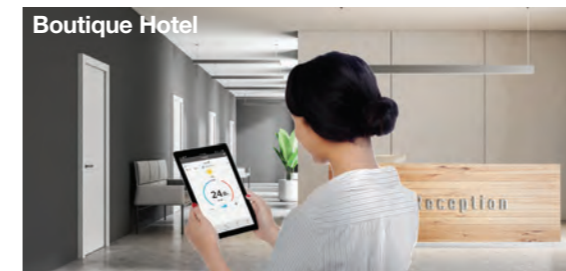

Centralised control from reception.



Multiple location control for small businesses.

System configuration

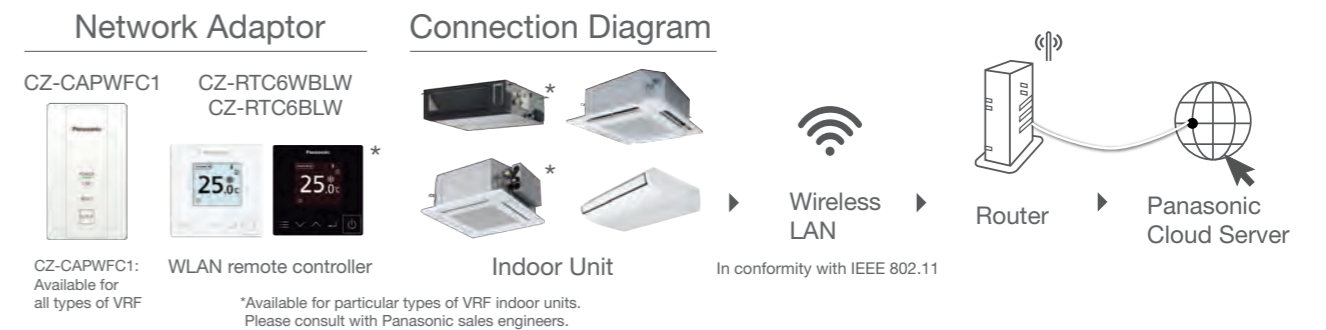

WLAN smart adaptor specification

	CZ-CAPWFC1
Input Voltage	DC 12V (Supplied from indoor unit)
Power Consumption	Maximum 2.4W
Size [H x W x D]	120 x 70 x 25mm
Weight	190g (including communications lines)
Interface	Wireless LAN
Wireless LAN Standard	IEEE 802.11 b/g/n
Frequency range	2.4GHz band
Encryption	WPA2-PSK(TKIP/AES)
Operation range	0-55°C, 20 - 80RH%



Comfort Cloud App



Scan QR code to download free Panasonic Comfort Cloud App

Compatible Device and Browsers

1. IOS 9.0 or above
2. Android™ 4.4 or above

VRF Smart Connectivity+

Through thorough energy management, Panasonic's VRF Smart Connectivity+ is a completely new, state-of-the-art solution providing energy saving and comfort as well as simple installation, operation and running.



Dramatic reduction of OpEx with outstanding IAQ.
 3 built-in sensors: Temperature, RH and occupancy.
 ZigBee wireless sensors: CO₂ / temperature / RH%, window / door, ceiling / wall / water leakage.
 Relay Pack, Hotel Room Controller.



User-/owner-friendly.
 Colour touch screen.
 Simple and easy to use.
 22 languages.
 Easy-to-understand error description.



Ultimate customisation.
 Customisable colour background.
 Custom display/icons, messages.
 Programmable logic (also stand alone).
 Various controls and various external connection devices.



Easy design and Plug & Play to reduce CapEx.
 Simple Plug & Play VRF connection to Building Energy Management System (BEMS).
 Stand alone or BEMS connected.
 Easy installation of ZigBee sensors.



VRF Smart Connectivity+ offers efficient energy management and a new air conditioning control solution with high IAQ (indoor air quality).

Energy management system for rooms.

Each room is monitored by high-precision sensors, making it possible to make every room's temperature comfortable without wasting energy.

Management system for the entire building.

A Building Energy Management System (BEMS) can also be connected for Plug & Play centralised control of the building's entire energy consumption.

1 Quality air control

Optimum IAQ is realized using the CO₂ and humidity sensors. The interior environment remains comfortable, while heating and cooling costs are minimized. The CO₂ sensor can control ventilation systems, which contribute to improving the room's air quality.

2 Easy installation and integration

A remote controller is all that's required for occupancy control and optimum automatic indoor air quality (IAQ) control. Simple operation with a rented interface further contributes to increased energy efficiency and productivity for reduced capital expenditure (CapEx) and operating expense (OpEx).

3 Other equipment control

One room controller manages various devices including lighting and the blinds. A ventilation system and other external connection devices can be connected by using HRC or SE8350 so that various control is possible with this controller alone, even without BMS.

VRF Smart Connectivity+: SER8150.

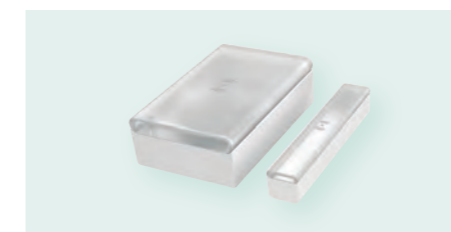

Door/window sensor.
 Door and window contact detection sensor to monitor opening and closing.

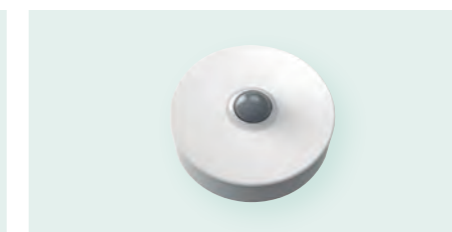

Wall/ceiling motion/temperature/humidity sensor.
 Wall and ceiling sensor to detect the presence or absence of occupants.



CO₂ /temperature/humidity sensor.
 Monitor indoor air quality, review data on interfacing devices, and control fresh air inside customisable zones.



Water leakage sensor.
 Two sensing pads under the body activate when water is present between the two pads. Detecting the water, the sensor reports the event to the controller (and BEMS).



Hotel Room Controller (HRC).
 The Hotel Room Controller controls connected guest room devices and aggregates data, making it visible to guest room and property management systems.

Energy management system for rooms

By installing a wall/ceiling motion temperature sensor, window/door sensor, and CO₂ sensor in the room, ideal, waste-free air conditioning is achieved.

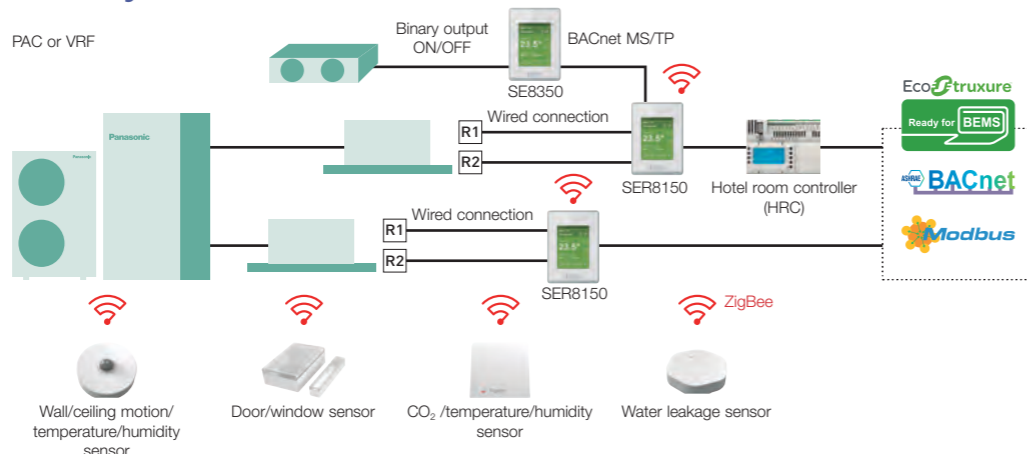

Sensing and control technology

Using sensors from Schneider Electric, high-quality occupancy control and automatic IAQ control are realised. The sensors detect the presence or absence of occupants, and the opening and closing of doors and windows to achieve the most efficient energy management for exceptional air-conditioned comfort. Flexible installation is possible to match different applications and building features such as walls, ceilings and proximity to doors and windows. No wiring means extra installation versatility.

Batteries last for up to five years (10-year battery for CO₂ sensor) and are easy to install and replace.

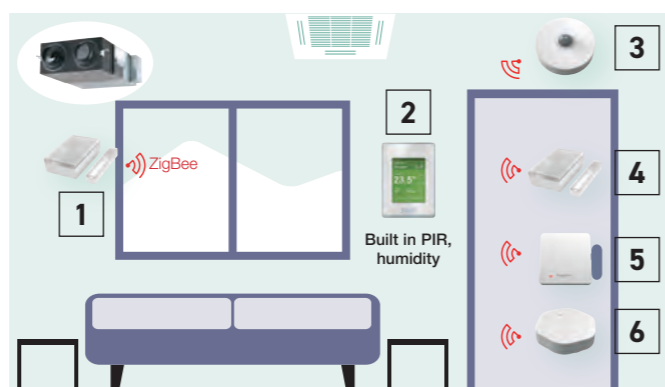

1 | Window sensor (option). 2 | Room controller. 3 | Ceiling motion sensor (option). 4 | Door sensor (option). 5 | CO₂ sensor (option). 6 | Water leakage sensor (option).

Pana Net Con, RH, No PIR, SE Brand, R1R2. SER8150R0B1194

Pana Net Con, RH, PIR, SE Brand, R1R2. SER8150R5B1194

Wireless ZigBee® Pro communication card. VCM8000V5094P

Hotel room expansion module 14 indoor units. HRCEP14R

Hotel room controller 28 indoor units. HRCBPBG28R

Hotel room controller w/display 42 indoor units. HRCPDG42R

* Those accessories require system integrator support on site.

Sensor with room CO₂, temperature and humidity. SED-CO2-G-5045

Sensor with room temperature and humidity. SED-TRH-G-5045

Door/window sensor. SED-WDC-G-5045

Wall/ceiling motion/temperature/humidity sensor. SED-MTH-G-5045

Water leakage sensor. SED-WLS-G-5045

Cover frame. Silver. FAS-00

Cover frame. White. FAS-01

Cover frame. Glossy translucent white. FAS-03

Cover frame. Light tan wood. FAS-05

Cover frame. Dark brown wood. FAS-06

Cover frame. Dark black wood. FAS-07

Cover frame. Brushed steel finish. FAS-10

Up to 5 year battery life (batteries included). Battery life of CO₂ sensor up to 10 years. Battery level data point.

Smart management solutions

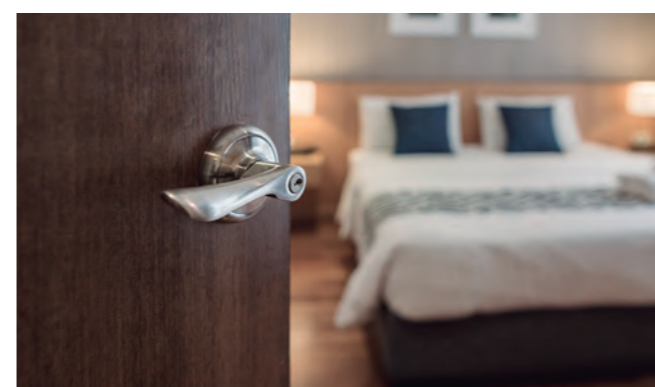

1 Hotels

Room key card or key cardless solutions for hotels. The SER8150 and ZigBee sensor automatic detection function offer optimal air conditioning regardless of whether there is a hotel room key or not. Sensors detect the presence or absence of occupants and the opening and closing of doors and windows for the optimum air-conditioned environment guests expect. Automatic control ensures the most efficient operation when guests are away or when windows are open. This contributes to an appreciable reduction in operation costs.



2 Small and medium offices

CO₂ sensors (option) and humidity sensors. CO₂ sensors (option) take measurements in units of ppm, and humidity sensors enable fine air quality control. This creates the most comfortable space for occupants while contributing to improved employee satisfaction.



3 Super markets

Humidity sensors. Humidity sensors enable automatic dehumidification for the optimum IAQ regardless of climatic conditions. This creates an even more comfortable environment for customers, employees, and products themselves.

Innovative and unrivalled advantages



Colour and design to match office interiors.
Colour combinations and design can be set to match different facilities.



Easy-to-understand error description.
Error description during an emergency is easy to understand, enabling staff to respond quickly.

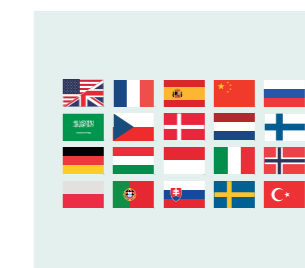

Customisation in 22 languages possible.
The display can be customised to match the native languages of guests to enable smooth, stress-free communication for hospitality at its finest.



Programmable logic.
Full customisation of remote controller logic possible, and updating to match conditions.

Panasonic AC Smart Cloud

With Panasonic AC Smart Cloud, have your business under control, and start saving!



Key functions and uniqueness

Multi site monitoring.

- It doesn't matter how many sites you have, easy to manage, operate, compare sites, locations, rooms.



Schedule setting.

- Yearly / weekly / holiday timer setting as you want



Powerful statistics for energy savings.

- Power consumption, capacity, efficiency level can be compared with different parameters (Yearly / monthly / weekly / daily bases)



Maintenance notification.

- Error notification by email and with floor layout
- Maintenance notification of PAC / VRF outdoor units
- Remote service checker function



User customisation¹.

Site administrator can create users as desired and assign customised profiles.

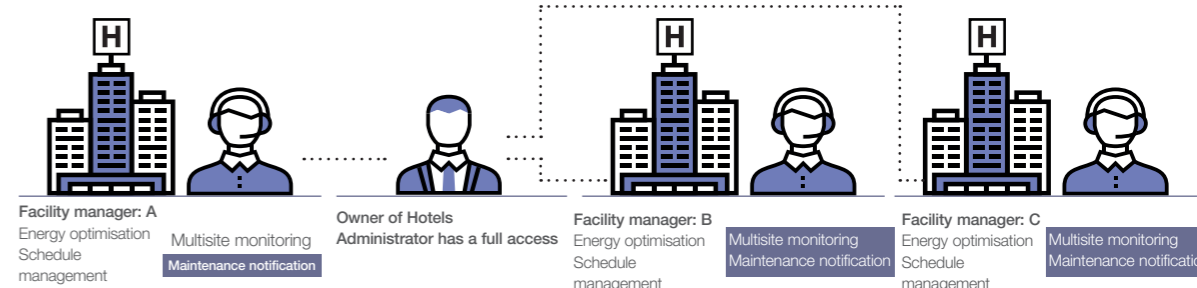

Flexible and scalable solution

- Energy saving
- Zero downtime
- Site(s) management

Centralise control of your business premises, from wherever you are, 24/7/365. It doesn't matter how many sites you have, or where they are!

The AC Smart Cloud system from Panasonic allows you to have complete control of all your installations, from your tablet or from your computer. In a simple click, all your units from several locations, receive status updates in real-time of all your installations, preventing breakdowns and optimising costs.

Flexible solution for your business.

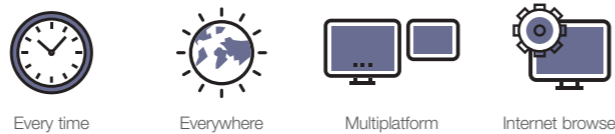

Scalable solution for your business.



¹ Customised to meet user demand / Continuous upgrades: new functions and product introductions / IT smart management.

Panasonic AC Smart Cloud offers continuous improvement always thinking about users

New e-CUT function

E-CUT functions are newly available in Panasonic AC Smart Cloud.

5 energy saving settings reduces automatically its energy consumption.

1. Set temperature auto return. When you want to return to the set temperature after a certain time even if the temperature is changed.

2. Unattended auto shut OFF. When you want to operate outside of a schedule but to monitor and stop automatically.

3. Set temperature range limit. When you want to limit the temperatures that can be set.

4. Energy saving timer / Efficient operation setting. Specify time slots when you want operation capacity reduced.

5. Demand / peak shaving settings/ Peak cut settings. Specify time slots when you want operation capacity of the outdoor units reduced.

Main functions per user type

Function / Main Tab	Sub-Tab	Basic type (Eg.: Owners, facility managers)	Professional type (Eg.: Installers, maintenance companies)
AC setting	I / U / O_U operation details	✓	✓
	Cloud adapter (CZ-CFUSCC1) details	✓	✓
	AC maintenance	✓	✓
	Map view	✓	✓
Energy saving function	NEW e-CUT	✓	✓
	Yearly, weekly schedule setting / view	✓	✓
Schedule	Power consumption	✓	✓
	Capacity	✓	✓
Powerful statistics	Efficiency ranking	✓	✓
Maintenance function	Notification overview / details	✓	✓
	Maintenance settings	✓	✓
	Map view	✓	✓
	Remote service checker	✓	✓
User account ¹	New / update user registration	✓	✓
	Distribution group overview / details	✓	✓
System setting	Cut OFF request	✓	✓
	Map editor		✓

Remote service checker function

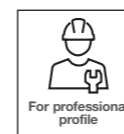

Zero down time

- Quick analysis & response
- Time & Cost saving for service maintenance task

Recording service checker parameters from wherever you are!

- Data duration: Maximum 120 minutes
- Data frequency: 10 – 90 seconds
- Mode selection: With test run or Without test run
- Count down schedule setting available

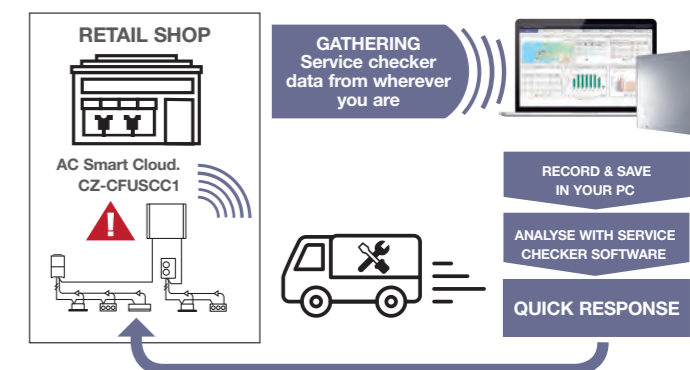

Panasonic AC Smart Cloud parts lists

¹ Cloud service fee is additionally required. Please contact an authorised Panasonic dealer.

CZ-CFUSCC1 AC Smart Cloud communication adaptor. Up to 128 groups. 128 units control

¹ Please contact an authorized Panasonic dealer.

FSV Controllers

A wide variety of control options to meet the requirements of different applications.

ECONAVI
ECONAVI Sensor
 CZ-CENSC1



Utilises ECONAVI Sensor and Control Program technologies to detect where energy is normally wasted and self-adjusts cooling power to reduce energy waste.

- Activity detection
- Absence detection

Operation system	Individual control systems			
Requirements	Simplified high-spec operation	High-spec operation	Normal operation	Operation from anywhere in the room
External appearance				
Type, model name	Simplified high-spec Wired Remote Controller with Bluetooth CZ-RTC6W/CZ-RTC6WBL/ *CZ-RTC6WBLW (White) CZ-RTC6/CZ-RTC6BL/ *CZ-RTC6BLW (Black) <small>*Available for particular types of VRF indoor units.</small>	High-spec Wired Remote Controller CZ-RTC5B	Timer Remote Controller (Wired) CZ-RTC4	Wireless Remote Controller Controller: CZ-RWS3 Receiver: CZ-RWRU3 CZ-RWRY3 CZ-RWRL3 CZ-RWRD3 CZ-RWRT3 CZ-RWRC3
Built-in thermostat	●	●	●	—
nanoe™ X on/off control <small>*not applies to Floor Console</small>	●	●	—	●
ECONAVI ON/OFF control	●	●	●	●
Number of indoor units which can be controlled	1 group, 8 units	1 group, 8 units	1 group, 8 units	1 group, 8 units
Use limitations	· CZ-RTC6(W) : Up to 2 controllers can be connected per group (only combination possible with CZ-RTC6(W)) · CZ-RTC6(W)BL/CZ-RTC6(W)BLW : Up to 1 controller can be connected per group	· Up to 2 controllers can be connected per group (When using ECONAVI sensor, only one remote controller is possible to connect at indoor unit)	· Up to 2 controllers can be connected per group (When using ECONAVI sensor, only one remote controller is possible to connect at indoor unit)	· Up to 2 controllers can be connected per group.
Function ON/OFF	●	●	●	●
Mode setting	●	●	●	●
Fan speed setting	●	●	●	●
Temperature setting	●	●	●	●
Air flow direction	●	●	●	●
Permit/Prohibit switching	—	—	—	—
Weekly program *	●	●	●	—

All specifications are subject to change without notice.
 *(CZ-RTC6(W)BL/CZ-RTC6(W)BLW with H&C Control App)

Timer operation	Centralised control systems				BMS System PC Base	Connection with 3rd Party Controller
Daily and weekly program	Operation with various functions from a central location	Only ON/OFF operation from a central location	Simplified load distribution ratio (LDR) for each tenant 10.4 in. touch screen panel color LCD			
Schedule Timer					 P-AIMS Software Up to 1024 units CZ-CSWKC2	 Seri-Para I/O unit for outdoor unit CZ-CAPDC2
CZ-ESWC2	System Controller CZ-64ESMC3	ON/OFF Controller CZ-ANC3	Intelligent Controller CZ-256ESMC3 (CZ-CFUNC2)		 Optional software CZ-CSWAC2 for Load distribution CZ-CSWWC2 for Web application CZ-CSWGC2 for Object layout display CZ-CSWBC2 for BACnet software interface *PC required (field supply)	 Interface Adaptor CZ-CAPC3 Seri-Para I/O unit for each indoor unit CZ-CAPBC2
64 groups, max. 64 units	· Required power supply from the system controller · When there is no system controller, connection is possible to the T10 terminal of an indoor unit.	· Up to 10 controllers, can be connected to one system. · Main unit/sub unit (1 main unit + 1 sub unit) connection is possible. · Use without remote controller is possible.	· Up to 8 controllers (4 main units + 4 sub units) can be connected to one system. · Use without remote controller is impossible.	· A communication adaptor (CZ-CFUNC2) must be installed for three or more links.		 Communication Adaptor CZ-CFUNC2 LonWorks Interface CZ-CLNC2
—	●	●	●			
—	●	—	●			
—	●	—	●			
—	●	—	●			
—	●	—	●			
—	●	●	●			
●	●	—	●			

Panasonic Total Air Conditioning Management System P-AIMS

P-AIMS basic software / CZ-CSWKC2

Up to 1024 indoor units can be controlled by one PC

Functions of basic software

- Standard remote control for all indoor units
- Many timer schedule programs can be set on the calendar
- Detailed information display for alarms
- CSV file output with alarm history, operating status.
- Automatic data backup to HDD



With 4 upgrade packages the basic software can be upgraded to suit individual requirements. For Load Distribution software, digital power meter c/w pulse require (field supply)



CZ-CFUNC2

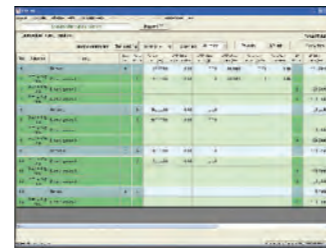

The P-AIMS is ideal for large areas/buildings such as shopping centers, universities and office buildings.

Each line can have max.8 communication adaptors units, and control max.512 units.

In total, 1024 indoor units can be controlled by 1 "P-AIMS" PC.

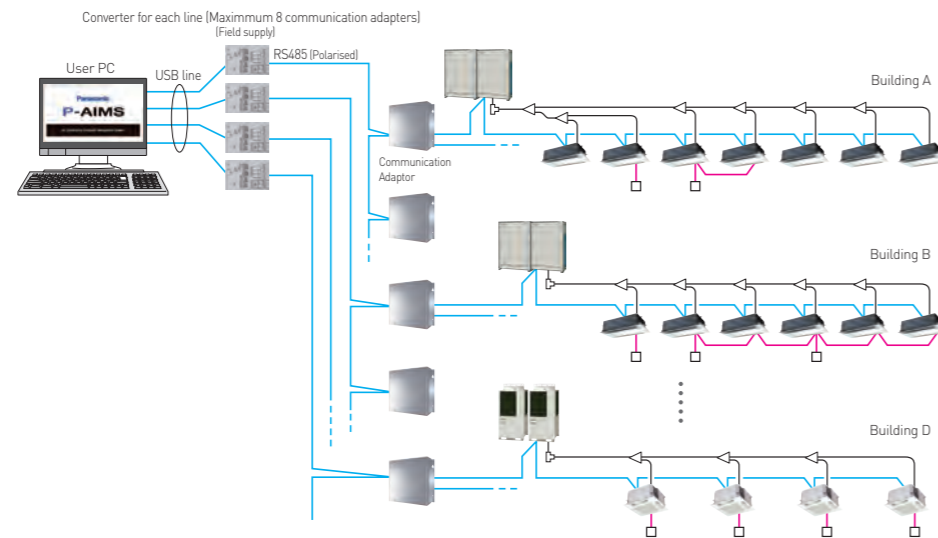

Recommended computer specs (Desktop type)

Operating system	Windows 10 Pro 64bit
CPU	Intel Core™ i5-6500 3.20GHz or higher (Recommended computer) Intel Core™ i7-7700 3.60GHz or higher (When installing Layout Display Software or using 512 or more indoor units)
Memory	8GB or larger
HDD	SSD (Solid State Drive) 250GB or larger
Monitor	1920 × 1080 (full HD) Recommended (1280 × 1024 (SXGA) minimum) 1920 × 1080 (full HD) Required (when installing Layout Display Software)
External HDD	500GB or larger (An external power supply type is preferable because the HDD will be used for backing up data.)
LAN	Network adaptor equipped machine (when Web Software or BACnet Communication Software installed)
UPS (Field Supply)	Select a UPS with a sine output wave form

Intelligent Controller (CZ-256ESMC3)



Touch panel Dimensions: H 240 x W 280 x D 85 mm
Power supply: AC 100 to 240 V (50/60 Hz)
LCD: 10.4 in. TFT, XGA(1024 x 768), LED backlight
UPS (Field Supply): select UPS with a sine output wave form

Product features

- 10.4 in., large, easy-to-use color LCD
 - With smartphone like operations, such as swiping and flicking
- Enhanced energy-saving control functions
 - Packed with demand functions
 - Set temperature auto return settings, Auto shutoff, Set temperature range limit settings
- Energy visualization
 - Displays electricity & gas usage distribution
 - Supports energy-saving plans with graph display function

New features

- Max 256 indoor unit [4 links x 64 units] can be controlled. In case of three or more links [more than 128 units], a communication adaptor CZ-CFUNC2 must be installed for three or more links.
- Operation is possible as batch, in zone units, and in group units.
- ON/OFF, operation mode setting, temperature setting, for fan speed setting,

air flow direction setting (when used without a remote controller) and remote controller local operation prohibition [prohibition 1,2,3,4] can be done

- Graph display [trends, comparisons]
- ECONAVI ON/OFF
- Outdoor unit quiet operation ON/OFF
- Energy-saving functions
- Event control [such as equipment linkage]
- Limitation contents for prohibited operation

Prohibition means limitation of the operation contents from the remote controller. It is also possible to change the prohibition items.

Limitation contents (Limitations can be user defined)

Individual	There is no limitation for the operation of the remote controller. However, the contents will be changed to the contents of the controller operated last. (Last-pressed priority.)
Prohibition 1	The remote controller cannot be used for ON/OFF. (All other operations are possible from the remote controller.)
Prohibition 2	The remote controller cannot be used for ON/OFF, operation mode change and temperature setting. (All other operations are possible from the remote controller.)
Prohibition 3	The remote controller cannot be used for operation mode change and temperature setting. (All other operations are possible from the remote controller.)
Prohibition 4	The remote controller cannot be used for operation mode change. (All other operations are possible from the remote controller.)

Remote control

The LAN terminal on this unit enables you to connect to a network. Connecting to internet will enable you to operate the unit and check the status using a PC from remote location.

Power Distribution function

You can view cumulative electrical consumption per indoor unit or in a area. Digital power meter with pulse require (Field Supply) for this function

Gateways for Panasonic AC systems integration



INTESIS PORTFOLIO FOR PANASONIC AIR CONDITIONING SYSTEMS ENSURE THE PERFECT INTERCONNECTION BETWEEN THE MOST EXTENDED PROTOCOLS INTO BUILDING AUTOMATION AND PANASONIC SYSTEMS.

The products from Intesis make it easy to meet Panasonic integration needs, giving the possibility to control from domestic AC lines to the most recent FSV systems.

From the automation side, it does not matter the model of your Panasonic unit.

Multiple indoor unit gateways:

Connection to S-link bus from the outdoor units (one or two lines)

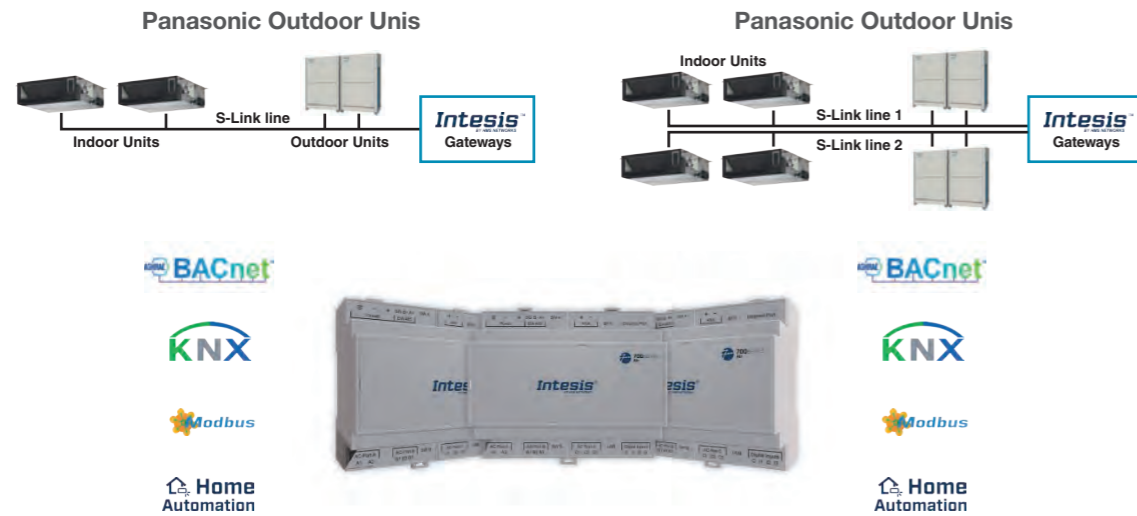

Connection	BACnet	KNX	Modbus	Home Automation	Note
S-Link (U1U2)	IN770PAN00S0000: Small version - Up to 16 Indoor Units, 30 Outdoor Units. IN770PAN00M0000: Medium version - Up to 64 Indoor Units, 30 Outdoor Units IN771PAN00L0000: Large version - Up to 128 Indoor Units, 60 Outdoor Units				Configuration tool MAPS the protocol of your controlling system: BACnet, Modbus, KNX or Home Automation

Connection with Panasonic AC indoor units

Individual Controllers:

- Infrared communication with IR receiver (bidirectional)



Connection	BACnet	KNX	Modbus	Home Automation	AC Cloud Control
Infrared (IR)	IN485UNI0011100 Universal Infrared AC Can be configured as BACnet MS/TP or Modbus RTU using MAPS. 1 Indoor unit	INKNXUNI0011000 Universal Infrared AC 1 Indoor unit 2 Binary inputs	IN485UNI0011100 Universal Infrared AC Can be configured as BACnet MS/TP or Modbus RTU using MAPS. 1 Indoor unit	INWMPUNI0011000 Universal Infrared AC 1 Indoor unit	INWFIUNI0011000 Universal Infrared AC 1 Indoor unit 1 Binary input

- Connection to CN-CNT port from the indoor unit



Connection	BACnet	KNX	Modbus	Home Automation	AC Cloud Control
CN-CNT	INBACPAN0011000 IN485PAN0011000 AC units 1 Indoor unit	INKNXPAN0011000 AC units 1 Indoor unit, 4 Binary Inputs INKNXPAN001A000 Air to Water (Aquaregia H) 1 Indoor unit	INMBSPAN0011100 AC units 1 Indoor unit INMBSPAN001A000 Air to Water (Aquaregia H) 1 Indoor unit	INWMPAN0011000 AC units 1 Indoor unit	INWFIPAN0011000 AC units 1 Indoor unit

- Connection to R1R2 port from the wired remote controller bus

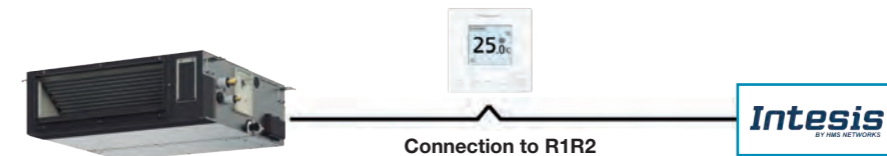

Connection	BACnet	KNX	Modbus	Home Automation	AC Cloud Control
R1R2	INBACPAN001R000 INBACPAN001R100 VRF and PAC Systems 1 Indoor unit	INKNXPAN001R000 VRF and PAC Systems 1 Indoor unit 4 Binary inputs	INMBSPAN001R000 VRF and PAC Systems 1 Indoor unit	INWMPAN001R000 VRF and PAC Systems 1 Indoor unit	INWFIPAN001R100 VRF and PAC Systems 1 Indoor unit

Panasonic VRF Global Project References

Panasonic air conditioning systems provides comprehensive solutions to businesses around the world. Harnessing our advanced technology and extensive on-site expertise, we serve clients in a diverse range of environments throughout the world.

HOTEL

Australia Travelodge Hobart



Air Conditioning System:
VRF 3-way MF2 series 8 systems
Indoor Units: 116 units
Cooling Capacity:
302 kW / 86 USRT

Indonesia Patra Jasa Hotel



Air Conditioning System:
VRF 2-way ME1 series 14 systems
Indoor Units: 132 units
Cooling Capacity:
677 kW / 193 USRT

Spain Hotel Claris 5 GL



Air Conditioning System:
VRF 2-way ME1&LE1 series 11 systems
VRF 3-way MF1 series 14 systems
Indoor Units: 233 units
Cooling Capacity: 769 kW / 218 USRT

Spain Monument Hotel



Air Conditioning System:
VRF 2-way ME1 series 4 systems,
VRF 3-way 12 systems
Indoor Units: 171 units
Cooling Capacity:
592 kW / 168.33 USRT

Spain LAVIDA Hotel PGA Catalunya Resort

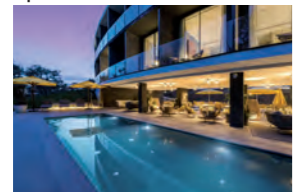

Air Conditioning System:
VRF 2-way FSV ME2 series 2 systems
Indoor Units: 54 units
Cooling Capacity: 236 kW / 67 USRT

Russia River Park Hotel



Air Conditioning System:
VRF 2-way ME1 series 47 systems
Indoor Units: 96 units
Cooling Capacity: 788 kW / 224 USRT

Germany The LEGOLAND Castle Hotel



Air Conditioning System:
VRF 3-way MF2 12 systems
Indoor Units: 144 units
Cooling Capacity:
592 kW / 168.33 USRT

Ireland K Club, Co. Kildare



Air Conditioning System: VRF 3-way FSV MF2
Indoor Units: 70 units
Cooling Capacity: 200 kW / 56.87 USRT

OFFICE

Malaysia Gapruna project



Air Conditioning System:
VRF 2-way FSV ME1 series 109 systems
Indoor Units: 537 units
Cooling Capacity:
5,370 kW / 1,526 USRT

Malaysia Plaza 33 Office Block A

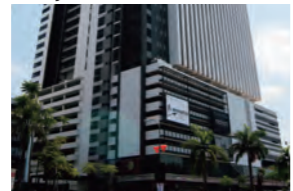

Air Conditioning System:
VRF 2-way FSV ME1 series 99 systems
Indoor Units: 153 units
Cooling Capacity:
3,667 kW / 1,042 USRT

Thailand Areeya



Air Conditioning System:
VRF 2-way FSV ME1 series 19 systems
Single split system 67 systems
Indoor Units: 85 units
Cooling Capacity:
1,519 kW / 432 USRT

HongKong King Yip Road



Air Conditioning System:
VRF FSM LA1 series 136 systems
Indoor Units: 294 units
Cooling Capacity:
2,108 kW / 599 USRT

England Soapworks

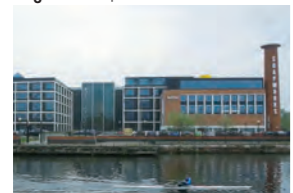

Air Conditioning System:
VRF 3-way MF2 77 systems
with ERV 167 systems

Spain PTA Malaga



Air Conditioning System:
VRF 2-way ME1 series 20 systems
Indoor Units: 74 units
Cooling Capacity:
908 kW / 258 USRT

Russia Russian Government Building



Air Conditioning System:
VRF 2-way ME1 series 42 systems
Indoor Units: 277 units
Cooling Capacity:
2,045 kW / 581 USRT

New Zealand IAG Christchurch



Air Conditioning System:
VRF 3-PIPE FSV MF2 series: 25 systems
Indoor Units: 132 units
Cooling Capacity:
976 kW / 278 USRT

RETAIL

Italy Le Centurie CENTRO COMMERCIALE



Air Conditioning System:
VRF 3-way MF1 series 18 systems
Indoor Units: 57 units
Cooling Capacity:
656 kW / 186 USRT

India Sai Aarav Motors, Mehsana



Air Conditioning System:
VRF 2-way FSV ME1 series 3 systems
Indoor Units: 19 units
Cooling Capacity: 156 kW / 44 USRT

Russia Sun City Mall



Air Conditioning System:
VRF 2-way ME1 series 47 systems,
VRF 3-way 12 systems
Indoor Units: 283 units
Cooling Capacity:
1,605 kW / 456 USRT

SCHOOL

United States Shippensburg University



Air Conditioning System:
VRF 3-Way MF1 series 55 systems
Indoor Units: 530 units
Cooling Capacity:
1,498 kW / 426 USRT

SCHOOL

Malaysia Xiamen University



Air Conditioning System:
VRF FSV Systems 110 systems
Indoor Units: 1,349 units
Cloud adapter: CZ-CFUSCC1 17pcs

Russia Technopark of Nobosibirsk Academgorodok



Air Conditioning System:
VRF 2-way ME1 series 38 systems,
VRF 3-way 12 systems
Indoor Units: 234 units
Cooling Capacity:
1,487 kW / 422 USRT

HOSPITAL

Indonesia Bekasi Hospital



Air Conditioning System:
VRF 2-way FSV ME1 series 42 systems
Indoor Units: 283 units
Cooling Capacity:
1,834 kW / 524 USRT

Indonesia Persada Hospital



Air Conditioning System:
VRF 2-way FSV ME1 series 21 systems
Indoor Units: 116 units
Cooling Capacity:
989 kW / 281 USRT

HOSPITAL

France Clinique Dentaire Ablis (Dental Clinic)



Air Conditioning System:
mini VRF 2-way mini FSV LE1 series 3 systems
Cooling Capacity:
36.3 kW / 10.3 USRT

RESIDENTIAL

China Star River Group Luxury Condominium



Air Conditioning System:
VRF Master series 966 systems
Indoor Units: 3,948 systems
Cooling Capacity:
16,737 kW / 4,755 USRT

Singapore Punggol Eco-Town



Air Conditioning System:
Inverter multi-split room air conditioner
Indoor Units:
Wall mounted S series (with ECRWV)
Control System: Panasonic HEMS

Hong Kong Gloucester Road Project

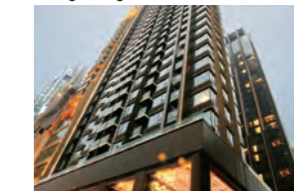

Air Conditioning System:
VRF FSM LA1 series 67 systems
Twenty series 105 systems
Indoor Units: 255 units
Cooling Capacity: 1,391 kW / 395 USRT

Hong Kong The Green Project



Air Conditioning System:
VRF FSM LA1 series 239 systems
Twenty series 538 systems
Indoor Units: 999 units
Cooling Capacity:
6,425 kW / 1,825 USRT

India Royal Orchids Eco-Green Homz



Air Conditioning System:
VRF 2-way FSV ME1 series 22 systems,
Indoor Units: 139 units
Cooling Capacity:
802 kW / 228 USRT

India Heera Windfaire



Air Conditioning System:
VRF 2-way FSV ME1 series 96 systems,
VRF 3-way 12 systems
Indoor Units: 479 units
Cooling Capacity: 2,184kW / 620 USRT

Panama Mosaic Building PANAMA PACIFICO



Air Conditioning System:
VRF 2-way FSV LE1 series 156 systems
Indoor Units: 357 units
Cooling Capacity: 2,338 kW / 664 USRT

Panasonic Pro Club Global



PRO Club Global Online Professional Support System



Panasonic has an impressive range of support services for designers, specifiers, engineers and distributors working in the air-conditioning business.

Panasonic PRO Club Global (www.panasonicproclub.global) is an online tool designed to make your professional life easier. Just sign up to gain access to a broad range of functions, wherever you are, from your computer or smartphone.

- Get all the documents you need, including the latest catalogues and leaflets
- Print selected catalogues including your logo and contact information
- Download service manuals, end-user manuals and installation manuals
- Learn what to do about error codes
- Be the first to receive the latest news and releases

Highlighted Features

- Special offers and promotions
- PDF catalogue downloads
- Marketing tool downloads (high-resolution product images, and more)
- Tools (professional software)
- Sales materials that can be customized with your logo and contact information
- Error code and model number searches
- CAD images, specifications
- Online technical documentation

**Building Passion,
Building Solutions.**
Panasonic Air Conditioning Systems

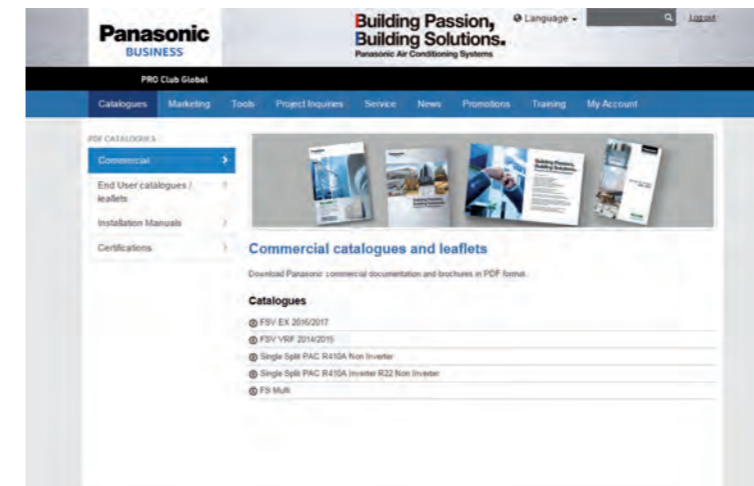

Quick download of catalogues and manuals.



Panasonic PRO Club is fully compatible with tablets, computers and smartphone

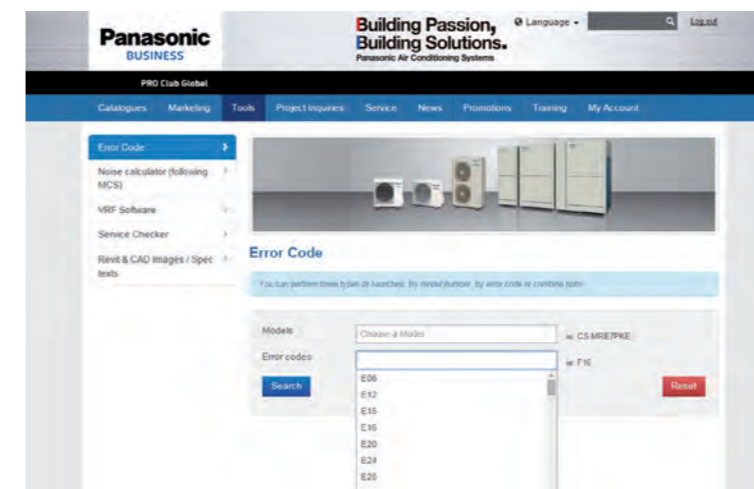

Search by error code or model reference on your smartphone or computer.



Panasonic PRO Club

Panasonic is committed to supporting its distributors, specifiers and installers and has developed comprehensive training programs. Training is offered at Panasonic training centers. The training centers display the latest Panasonic product range and give trainees an opportunity to get hands-on experience with the latest controllers and indoor/outdoor units.



VRF Software for air-conditioning professional and consultants